



UNIVERSITEIT VAN PRETORIA  
UNIVERSITY OF PRETORIA  
YUNIBESITHI YA PRETORIA

**MOLECULAR TAXONOMIC  
STUDIES OF SELECTED SPECIES IN  
THE *GIBBERELLA FUJIKUROI*  
COMPLEX**

by

**Emma Theodora Steenkamp**

**November 2000**

**Promoter: Prof. B.D. Wingfield**

**Co-promoter: Prof. M.J. Wingfield**

**Prof. T.A. Coutinho**

**Prof. W.F.O. Marasas**

**Submitted in partial fulfillment of the requirements for the degree of Philosophiae Doctor  
in the Faculty of Biological and Agricultural Science,  
Department of Microbiology and Plant Pathology  
at the University of Pretoria.**



# TABLE OF CONTENTS

<b>ACKNOWLEDGEMENTS</b>	i
<b>PREFACE</b>	ii
<b>CHAPTER 1</b> Literature review: The use of protein-coding genes in fungal taxonomy	1
<b>CHAPTER 2</b> Differentiation of <i>Fusarium subglutinans</i> f. sp. <i>pini</i> by histone gene sequence data	52
<b>CHAPTER 3</b> PCR-based identification of <i>MAT-1</i> and <i>MAT-2</i> in the <i>Gibberella fujikuroi</i> complex	70
<b>CHAPTER 4</b> Molecular characterization of <i>Fusarium subglutinans</i> associated with mango malformation	86
<b>CHAPTER 5</b> <i>Gibberella fujikuroi</i> mating population E associated with maize and teosinte species	103
<b>CHAPTER 6</b> Cryptic speciation in <i>Gibberella fujikuroi</i> mating population E	120
<b>CHAPTER 7</b> Molecular and morphological comparison of <i>Fusarium</i> species representing <i>F. subglutinans sensu lato</i>	141
<b>SUMMARY</b>	160
<b>OPSOMMING</b>	162
<b>APPENDIX 1</b>	A-1
<b>APPENDIX 2</b>	A-9
<b>APPENDIX 3</b>	A-14
<b>APPENDIX 4</b>	A-29
<b>APPENDIX 5</b>	A-42
<b>APPENDIX 6</b>	A-61

I wish to express my sincere thanks and appreciation to the following people and institutions:

Profs. B.D. Wingfield, M.J. Wingfield, W.F.O. Marasas and Dr. T.A. Coutinho, for their capable and enthusiastic guidance and advice;

Drs. J.F. Leslie, A.E. Desjardins and K.A. Zeller, as well as Ms. Henriette Britz and Ms. Riana Jacobs for their contribution to certain manuscripts, supply of cultures, useful discussions and advice on this project;

National Research Foundation (NRF) and the University of Pretoria for financial support;

Members of the Tree Pathology Co-operative Programme (TPCP) for opportunities to collect fungi and for financial support;

Department of Genetics at the University of Pretoria for use of facilities;

Department of Microbiology and Biochemistry at the University of the Orange Free State, for financial support and use of facilities during the first two years of this project;

My family and friends for their interest, advice and support throughout the course of this project.

## PREFACE

*Fusarium subglutinans* forms part of the *Gibberella fujikuroi* complex. This species aggregate has been associated with different plant hosts, as well as at least three mating populations in the *G. fujikuroi* complex. However, *F. subglutinans* is a polyphyletic taxon (= *F. subglutinans sensu lato*), because each of these mating populations and lineages associated with the different hosts constitutes a discrete species. These different species are virtually identical when compared using morphological characteristics. The major goal of this study was to characterize some of the species representing *F. subglutinans sensu lato* using various protein-coding gene sequences. Methods to aid in the identification and differentiation of the fungi comprising *F. subglutinans sensu lato* were also developed. This thesis is, therefore, presented as a compilation of chapters that each deals with different approaches and techniques to study the taxonomy and biology of *F. subglutinans sensu lato*.

Most studies on the phylogeny and taxonomy of species in the *G. fujikuroi* complex have used protein-coding gene sequences. This is because the more widely used ribosomal DNA sequences do not provide sufficient resolution in these fungi. Their use is also complicated by the presence of paralogous internal transcribed spacer regions. Although several authors have presented extensive reviews on the use of ribosomal DNA sequences in taxonomy, no such reviews are available for the use of genes that encode proteins. A comprehensive literature review dealing with this issue is, therefore, presented in chapter one.

Pitch canker of mature pines and root rot of pine seedlings are important forestry diseases. The causal agent of these diseases is *F. subglutinans* f. sp. *pini*. This fungus is morphologically almost indistinguishable from other species of *F. subglutinans sensu lato*. The lack of a reliable identification system has hampered the implementation of disease management programs and quarantine measures. In chapter two, a PCR-based identification technique for *F. subglutinans* f. sp. *pini* is reported. This technique is based on the presence of unique restriction fragment length polymorphisms in the amplified portion of the histone *H3* gene of this fungus.

The biological species concept is frequently used for studying the fungi in the *G. fujikuroi* complex. Application of this concept for the classification of these fungi is relatively straightforward since they are heterothallic, having one of two possible mating types (*MAT-1* or *MAT-2*). To simplify the identification of isolates with opposite mating types, a PCR-based method was developed and is presented in chapter three. Partial DNA sequences for the two *MAT* loci (idiomorphs) were determined and used to construct mating type specific primers.

Chapter four reports on two distinct phylogenetic species associated with the disease known



as mango malformation. This study was based on the DNA sequence for the histone *H3* and  $\beta$ -tubulin genes. Both of the species associated with mango malformation display morphological characters typical of *F. subglutinans*. Since reliable identification procedures have not been available, the possible identity of these species was determined using a public domain nucleotide database and the internet-based programme BLAST.

Application of the biological species concept for classifying *Fusarium* isolates does not always yield definitive resolution of species. For example, sexually compatible isolates will be classified as the same species, whereas incompatible fungi do not necessarily represent separate species. Apart from "species barriers", factors such as female sterility and low fertility, greatly influence sexual compatibility tests. These factors may result in the genetic isolation of a population or species. Chapter five reports on such a genetically isolated population of isolates. Using the DNA sequence of two protein-coding genes, this population was shown to form part of the *G. fujikuroi* mating population E (*F. subglutinans sensu stricto*).

Chapter six reports on a recent speciation event within *G. fujikuroi* mating population E. The two cryptic species that emerged from the study are morphologically identical. They also have similar primary hosts, i.e. *Zea* spp. The speciation event was detected using a phylogenetic approach. For this purpose specific regions of three nuclear protein-coding genes, as well as three nuclear regions of unknown function were used.

Chapter seven represents a molecular and morphological comparison of the species comprising *F. subglutinans sensu lato*. All the available *Fusarium* isolates that were previously shown to display morphological characters that are typical of *F. subglutinans* were compared. From these comparisons, diagnostic morphological characters were identified. All these fungi were also compared using the gene sequences for three nuclear protein-coding genes, as well as the sequence for the mitochondrial small subunit ribosomal RNA gene. From the sequence of the most variable of these regions (elongation factor  $1\alpha$ ), diagnostic restriction enzyme recognition sites were identified and used for species delimitation.

Each of the seven chapters of this thesis represents an independent unit, three of which have already appeared in print. Studies were undertaken over a five-year period and repetition between chapters has been unavoidable. All the available synonyms for each *Fusarium* species are also not always provided. This was done to avoid confusion, since the current taxonomic status of many *Fusarium* species in the *G. fujikuroi* complex remains uncertain. Many of the lineages in *F. subglutinans sensu lato* have been renamed, whereas others have not yet been formally described. The fact that many of these newly described species are invalid (Index of fungi, 1999, 6:979-980) further complicates their nomenclature.



# **CHAPTER 1**

**LITERATURE REVIEW:**

**USING PROTEIN-CODING GENES IN  
FUNGAL TAXONOMY**

# USING PROTEIN-CODING GENES IN FUNGAL TAXONOMY

<b>1 INTRODUCTION</b>	<b>3</b>
<b>2 EXON-INTRON ORGANIZATION OF PROTEIN-CODING GENES</b>	<b>4</b>
2.1 INTRONS	4
2.1.1 Types of introns	4
2.1.2 The role of introns in biology	5
2.1.3 Origin of introns	5
2.1.4 Positional conservation	7
2.2 EXONS	8
2.2.1 Codon Bias	8
2.2.2 G+C content	9
2.2.3 Multiple overlapping substitutions	10
2.2.4 Transversion/transition ratio	10
<b>3 SINGLE AND MULTI-COPY GENES</b>	<b>11</b>
3.1 MULTI-COPY GENES	11
3.1.1 Types of multigene families	11
3.1.2 Concerted evolution	12
3.1.3 Example of a protein encoded by a multigene family: $\beta$ -tubulin	13
3.2 SINGLE COPY GENES	15
3.2.1 Examples of proteins encoded by single genes: largest and second largest subunits of DNA-dependent RNA polymerase II	15
<b>4 PROTEIN-CODING GENES AND FUNGAL TAXONOMY</b>	<b>16</b>
4.1 DEEP LEVEL FUNGAL TAXONOMY: THE MICROSPORIDIA-FUNGI RELATIONSHIP	16
4.2 LOW-LEVEL FUNGAL TAXONOMY	17
4.2.1 Interspecific relationships	17
4.2.2 Intraspecific relationships	18
<b>5 CONCLUSIONS</b>	<b>19</b>
<b>6 REFERENCES</b>	<b>20</b>
<b>7 TABLES</b>	<b>43</b>
<b>8 FIGURES</b>	<b>49</b>



## 1 INTRODUCTION

Since the onset of the application of molecular techniques, fungal taxonomy and phylogeny has been dominated by the use of the ribosomal RNA genes (*rrn*) 18S, 28S and 5.8S, as well as the internal transcribed spacers (ITS) separating these genes (see for example refs. 35, 119). Depending on the particular *rrn* gene used, taxonomic and phylogenetic questions at all levels have been addressed (see for example ref. 247). Unfortunately, phylogenetic trees inferred using these genes are often incongruent with fungal biology and they do not always provide sufficient resolution of the taxa being studied (see for example refs. 115, 170, 247, 254, 291, 293). The major reason for these irregularities and lack of resolution is that non-uniform evolutionary forces are potentially acting upon the *rrn* genes of closely related fungi. This problem is easily solved by including additional regions of the fungal genome in the analyses. For this purpose, fungal taxonomists and evolutionary biologists frequently use protein-coding genes (see for example refs. 212, 278).

Protein-coding genes can be applied to evolutionary questions at all taxonomic levels. They have, for example, been used to determine the root of the tree of life and to study the ancient eukaryotes (10, 77, 144, 149, 291). Protein-coding genes can also be applied successfully to lower (intra- and interspecies) and intermediate (intergenus or -order) taxonomic levels (18, 155, 170, 213). The use of protein-coding genes in phylogenetic studies has one major advantage over the use of *rrn* genes. Whereas only specific *rrn* genes can be used to address questions at certain levels, a single protein-coding gene, for example any one of the tubulin genes, can be used to address taxonomic questions at all levels (see for example refs. 11, 141, 214, 243).

Protein-coding genes are subjected to many different evolutionary forces, the effects of which can have profound implications on the interpretation of phylogenetic data. The purpose of this review is, partially, to discuss different forces acting on protein-coding genes and how they influence evolutionary reconstructions. This is done by providing background, firstly, on the structure of protein-coding genes and secondly, on the evolutionary forces that have shaped them. The discussion on protein-coding genes is mostly restricted to eukaryotic nuclear genes, but organellar and prokaryotic genes are briefly considered. The remainder of this review deals with the use of protein-coding genes in fungal taxonomy and provides some examples where they have been used successfully.

## 2 EXON-INTRON ORGANIZATION OF PROTEIN-CODING GENES

One of the most striking features of protein-coding genes is that they are generally organized into regions of coding sequences (exons) that are interrupted by intervening non-coding sequences (introns) (reviewed in ref. 31). Since these intervening sequences confer no apparent phenotype on the cell, and are thought to be without function, they are subjected to fewer evolutionary constraints than are exons (24, 65). Introns thus provide an attractive source of sequence variation in an otherwise highly conserved gene (6). In the following sections, introns are discussed with regard to their types, possible role in biology, origin and positional conservation. In addition phenomena specific to exons are reviewed. These include codon bias, G+C content, multiple overlapping substitutions or homoplasmy and transversion/transition ratios. In all cases, special attention is given to issues pertaining to the evolutionary forces that not only gave rise to these regions, but also those that are currently acting upon them.

### 2.1 Introns

#### 2.1.1 Types of introns

Introns are divided into different classes based on their mechanisms of splicing and in which genes they occur. Group I introns, for example, are found in the genomes of prokaryotes and organellar genomes. They have ribozymic activity and hence encode endonucleases that assist their splicing and trans-positioning (17, 72). Group II introns are also autocatalytic or self-splicing, but rather than encoding endonucleases, they generally encode reverse transcriptases (17). Group II introns are characteristic of prokaryotic and organellar genomes, where they are found in the genes encoding proteins, transfer RNAs (tRNAs) and ribosomal RNAs (rRNAs) (194). Group III introns are similar to group II intron, but differ in that their self-splicing mechanisms are somewhat defective (50, 194). Both group I and II introns are self-splicing and thus code for the 'machinery' necessary for their spread and/or removal.

Eukaryotic nuclear genes harbor a different type of intron that is generally referred to as a spliceosomal intron. Removal or splicing of this type of intron involves a multi-molecular RNA/protein complex or spliceosome that is formed through the interaction of a number of small nuclear ribonucleoproteins (snRNPs) (88, 104, 177). The structure and splicing mechanism of spliceosomal introns closely resembles that of group II introns, which suggests a common origin for spliceosomal and group II introns (43, 50, 65, 137, 160, 205, 236).

Spliceosomal introns are subdivided into two groups based on the consensus sequences at their splice sites (136, 200, 249, 289). The first and most common type is characterized by GT- and AG-dinucleotides at their 5' and 3' intron boundaries (Table 1) (289). Two types of spliceosomes can excise these GT-AG introns (Table 1). The most common type includes U2 snRNP as part of

the spliceosomal apparatus, whereas the other spliceosome include U12 snRNP (110, 136, 249, 289). The second type of spliceosomal intron has the dinucleotides AT and AC at its 5' and 3' boundaries (110, 200). The U2- and U12 types of spliceosomes also excise these AT-AC introns (Table 1). These AT-AC introns are, however, very rare. U12-type AT-AC introns occur at a frequency of less than one in five thousand, and U2-type AT-AC introns are even rarer, since there are only seven known examples (110, 111, 200, 269).

Spliceosomal introns are distinguished based on their phases. Intron phase refers to the placement of the intron relative to the reading frame (58). A phase 0 intron, for example, is situated exactly between two neighboring codons. Phase 1 and 2 introns split a codon after the first and second bases, respectively. Long and Deutsch (173) reported that most spliceosomal introns were of the phase 0-type. They further showed a strong correlation between intron phase and the degree of conservation of the splice signals in the exons surrounding an intron. In other words, the exonic sequences flanking phase 2 introns are most variable and are not in total agreement with the consensus sequences (Table 1). The exonic sequences surrounding a phase 0 intron usually match the consensus exactly. According to Long and Deutsch (173), the evolutionary forces determining the sequences surrounding a spliceosomal intron are strongly biased towards generating phase 0 introns. This is because variations in these splice signals produce phase 1 and phase 2 introns, which may lead to intron-loss associated with deleterious mutations. The relatively few phase 1 and 2 introns, therefore, reflect those cases where intron-losses were not associated with lethal mutations (173). This is illustrated in the  $\beta$ -tubulin genes of a diverse group of organisms, where more than half the introns are of the phase 0-type, while the remaining introns are phase 1 and 2 (Fig. 1).

### **2.1.2 The role of introns in biology**

Broadly speaking introns have no obvious function (24). They can be removed without any phenotypic effect. There are, however, reports of certain introns performing regulatory functions such as enhancing or modulating expression of the genes harboring them (78, 255). Several authors have further indicated that introns might play a role in genetic recombination by creating so-called 'hot spots' for crossing-over (22, 23, 25, 65, 96, 97). This 'loosening' of genetic linkage between exons, forms the basis for one of the models explaining the evolution of introns. Nevertheless, if introns do play biologically important roles, they would be subjected to evolutionary forces that are most probably different to those acting on the exon regions.

### **2.1.3 Origin of introns**

There are two opposing hypotheses for the origin of introns. These are known as the 'introns-early' and 'introns-late' theories (65). The 'introns-early' theory is also known as 'the exon

theory of genes' and suggests that the first exons were short (15-20 amino acid residues) and assembled by recombination within introns. According to this theory, the short exons (encoding functionally active polypeptides) were 'shuffled' to eventually form a gene consisting of many introns and exons. This suggests that primitive ancestral genes would have had many introns that separated various functionally active protein domains or exons. Divergence of prokaryotes and eukaryotes led to the loss of these introns through genomic streamlining in the case of prokaryotes, and retention associated with occasional loss of introns in the case of eukaryotes (65, 96, 98, 168, 185, 229, 248, 281).

Several lines of evidence are provided for the 'introns-early' theory (24, 64, 96, 98, 99, 168, 211). One of these is the relative position of introns in genes (168, 211). As is the case in many other genes (9, 79, 98, 185, 239, 281) the  $\beta$ -tubulin introns occur in clusters at regular intervals of 15-20 amino acid residues (Fig. 1) (168, 211). The positions of these introns also appear to be conserved over great evolutionary distances, suggesting that modern genes evolved via intron-loss from the ancestral intron-containing gene (Table 1).

The 'introns-late' theory suggests that prokaryotic genes most closely resemble the ancestral state (58, 59, 65, 172, 236). According to this model, spliceosomal introns evolved during eukaryotic evolution. These introns were then inserted into unsplit genes after the prokaryotic-eukaryotic 'transition' and have nothing to do with the development of genes (236). The 'introns-late' theory is supported by the presence of so-called proto-splice sites (172). These sites serve as recognition sequences for the insertion of introns (58). Proto-splice sites are characterized by the sequence KAG\*R (K = A or C; R = A or G and \* = splice junction), which closely resemble the exonic consensus surrounding intron splice junctions (Table 1). Such proto-splice sites are present at conserved positions in what is believed to be older intron-lacking versions of a gene. The 'introns-late' theory suggests that these proto-splice sites were present prior to evolutionary radiation (58, 172). The conserved positions of the proto-splice sites, therefore, determine the positions of introns (58, 172).

The origin of introns remains a controversial subject. Evidence for both the 'introns-late' and 'introns-early' models is inconclusive. Supporters of the 'introns-early' model interpret the presence of proto-splice sites as remnants of lost ancestral introns. Proponents of the 'introns-late' model find no statistically significant 'intron-splitting' of genes into functionally active domains (59, 277). They also argue that it is unlikely that large-scale intron-loss through genetic streamlining occurred twice in evolutionary history, once in the ancestor of all eubacteria and a second time in the archaeobacterial ancestor (236). It is thus clear that neither the 'introns-late' nor the 'introns-early' theories can be discredited. Recent computer assisted analyses of large numbers of conserved protein-coding genes has provided evidence that supports both models (238, 277). Some introns are



evolutionarily old and were probably involved in ancestral exon shuffling to create genes (82, 248, 281), whereas other introns were recently gained or lost (82, 172).

The opposing theories on the origin of introns complicates their use in phylogenetic inferences. This is because evolutionary reconstructions using protein-coding genes reflect the phylogenies of both the exons and introns. If the introns in question originated prior to the divergence of the group of organisms included in the analyses, the intronic history would reflect the phylogeny of the exonic regions. However, if these introns were 'acquired' during or after the divergence of the organisms in question, the intronic and exonic phylogenies would be different.

#### **2.1.4 Positional conservation**

The nucleotide sequences of many genes display a higher degree of variability in the 5'-half, than in the 3'-half, of the gene. This is mainly due to the fact that introns are not distributed uniformly within genes, but appear to be more abundant in the first or 5'-half. Examples of genes where introns are preferentially situated in the 5'-half, are  $\alpha$ - and  $\beta$ -tubulin (Fig. 1) (168), small G proteins (59), glyceraldehyde-3-phosphate dehydrogenase (185, 228), etc. This is either because of intron gain in the first portion of genes, or intron loss from the 3'- half of genes (58, 172, 236, 238).

Gain and loss of introns is explained using the 'introns reinsertion-homologous recombination' model. This model involves the spliceosome and proto-splice sites, mentioned earlier. Based on this model the loss or gain of an intron includes a four-step process (96, 168, 236), whereby the intron is (i) spliced from the premature messenger RNA (pre-mRNA) and (ii) reinserted into a nearby site of the pre-mRNA. This is followed by (iii) reverse transcription of the 'new' pre-mRNA into complimentary DNA (cDNA). The final step in this model is the (iv) reinsertion of this newly formed intron-containing cDNA into the genome via homologous recombination with the genomic copy. The result would be intron gain, but when step two is omitted, the result would be intron-loss. In other words, if the removed intron is not reinserted at a different position in the pre-mRNA, the pre-mRNA can be reverse transcribed and recombined back into the genome. This would generate a gene from which an intron has been deleted.

The involvement of a reverse transcription step in the 'intron reinsertion-homologous recombination' model provides an explanation for the polarization of genes with regard to intron position. According to this model, reverse transcription is always initiated at the 3'-end and seldom extends fully to the 5'-end of the pre-mRNA. Homologous recombination, therefore, results in 'replacement' of the 3'-portions of the gene with a reverse transcribed intron-less cDNA copy (85, 96, 185). In some genes, the involvement of reverse transcriptional errors at the 3' end of the gene has been used to explain why 5' intron positions are more conserved than the 3' intron positions (185, 228).



Intron positions in genes such as  $\beta$ -tubulin, are usually conserved across great evolutionary distances (168). Comparisons of intron positions in the  $\beta$ -tubulin genes from a diverse group of organisms (Fig. 1) has revealed that ascomycetous fungi are characterized by a unique intron (intron 5). The same is also true for the metazoan (intron 20) and plant lineages (intron 133) (Fig. 1). This conservation also extends to individual lineages, since all the fungi from the pyrenomycetous order Hypocreales have three specific introns in the first half of their  $\beta$ -tubulin genes (introns 5, 13 and 54). All the members of the lower plants also appear to harbor a unique intron (intron 57) in their  $\beta$ -tubulin genes. However, certain organisms have more than one  $\beta$ -tubulin gene per individual, each with unique intron positions. For example, the intron positions in the *tubC* and *benA*  $\beta$ -tubulin genes of *Aspergillus nidulans* are very different (Fig. 1).

Intron sequences are useful for answering phylogenetic questions at lower taxonomic levels. This is because it is possible to align homologous intron sequences from closely related taxa (6, 18, 63, 83, 212, 263, 285). However, 'homologous' introns of more divergent taxa usually only share the same position and little or no sequence homology (83, 172, 263, 280). For this reason the use of intron sequences for reconstructing deeper level phylogenies are not feasible (83, 158, 191, 310). To address this type of evolutionary question intronic regions can thus not be treated as nucleotide bases in phylogenetic analyses, but rather as 'presence' or 'absence' characters.

## 2.2 Exons

Exons are the coding regions of protein-coding genes. Their nucleotide base composition is, therefore, subjected to evolutionary forces that not only reflect lineage history, but also other constraints imposed at the translational and functional levels (30, 49, 131, 132, 292). Phenomena such as codon bias, G+C content, multiple overlapping substitutions and transversion/transition ratios serve as indicators of these selective forces, although they may in some cases also reflect gene and/or taxon phylogeny (1, 2, 30, 34, 55, 91, 130, 166, 171, 182, 235, 275, 298). These phenomena are not independent of one another and changes in one results in changes in the others. In the following sections, these interdependent factors are discussed in more detail.

### 2.2.1 Codon Bias

Codon bias is a phenomenon found in many protein-coding genes and is defined as the non-random use of synonymous codons (106). Leucine, for example, is encoded by six synonymous codons (CUU, CUC, CUA, CUG, UUA and UUG) and the preferential use of one during translation is referred to as codon bias. 'Non-biased' genes differ from biased genes, in that any of these codons can be used during translation. 'Non-biased' genes are further characterized by silent or synonymous substitutions rather than non-synonymous substitutions that would result in alteration of the amino acid sequence (36, 45, 117, 166, 292). For example, one or two substitutions in the

three nucleotide bases specifying an amino acid will generally be synonymous or silent. This is because the substitution results in a codon that still encodes the original amino acid. Non-synonymous substitutions that occur at the third nucleotide base are less frequent, since they will result in alteration of an amino acid residue that can lead to loss or decrease of functionality in the mature protein.

Codon bias is a prominent feature of highly expressed genes (45, 131, 251). It is determined and/or influenced by two main groups of factors. The first group of factors controls the efficiency of translation. The second group of factors control structural aspects of the gene without regard of translational efficiency (292). One of the factors that will influence translational efficiency is the abundance of a specific tRNA species (30, 49, 61, 103, 117, 130-132, 166, 225, 251, 289). In the yeast *Saccharomyces cerevisiae*, for example, the most abundant lysine tRNA species has the anticodon CUU, which will bias the codon usage of this amino acid towards AAG. Other tRNA species that will recognize the remaining lysine codon (AAA) are scarce and sometimes absent. The inclusion of this codon in the genes of the fungus will thus cause a reduction in translational efficiency. Such codons are, therefore, selected against and results in codon bias.

The second group of factors that will influence codon usage includes the requirements for gene and RNA secondary structure (224, 253). For example, portions of the downstream-untranslated regions of the alcohol dehydrogenase (*adh*) gene of *Drosophila*, interacts with nucleotides in the second exon of this gene. Synonymous substitutions (i.e. those that will not change the codon) in this exon, alter the secondary structure of the mRNA. This significantly reduces expression of the *adh* gene (224). This type of interaction, therefore, also contributes to the selection for specific codons.

Preferential use of certain codons is generally species and/or gene specific (1, 91, 159, 166), but is sometimes associated with phylogeny (106, 131, 132). Differences in the degree of codon bias can potentially have serious implications for determining evolutionary relationships. It is well documented that the use of many codon-biased genes distorts and obscures phylogenetic histories in many different eukaryotic and prokaryotic organisms (55, 81, 117, 125, 166, 167, 176, 182, 237, 292, 298).

### 2.2.2 G+C content

Variations in G+C content are usually located at the third bases of codons (30, 55, 166, 250, 292). This reduces the number of possible synonymous substitutions in a codon. For example, a bias towards high G+C content will reduce the number of codons (six) specifying a leucine residue to three codons. The codons CUU, CUA and UUA will be selected against and thus not occur. It is clear that G+C content and codon bias are very closely linked. For this reason the same

evolutionary forces that affect codon bias will generally also influence G+C content (36, 55, 81, 125, 166, 292).

### **2.2.3 Multiple overlapping substitutions**

Apart from the restrictive effects of codon bias and G+C content, a multiplicity of silent or synonymous substitutions can occur at a specific position during the evolutionary history of a gene or species (167). For example, the third base in the codon specifying a leucine, can change from T to C and back to T. This is termed a 'reversal' and together with other phenomena such as convergence and parallelism, is referred to as homoplasy (268). Many of these overlapping substitutions or homoplastic events will obliterate the historical information at that position. They can thus lead to an underestimation of the degree of divergence or an overestimation of the degree of similarity between different taxa (100, 237, 294). The use of these characters in evolutionary inferences, therefore, results in lack of phylogenetic resolution and inconsistencies (125, 233, 237, 294).

### **2.2.4 Transversion/transition ratio**

A transversion is defined as the substitution of a pyrimidine (C or T) for a purine (A or G) or vice versa. Transition is defined as substitution of a purine for a purine or a pyrimidine for a pyrimidine (167). According to DeSalle et al. (57), there is a general lack of transitional bias between distantly related taxa, because the record of transitional events is erased by transversions. This apparently results in an accumulation of transversions among more divergent genomes (34, 57, 124, 275). Transitions are, therefore, usually more abundant than transversions among closely related organisms (34, 55, 57, 117, 125, 167, 275).

Inference of phylogenetic relationships from protein-coding regions presupposes that evolutionary forces underlying nucleotide variation are common to all the taxa that are examined (167). However, many different selective forces and processes, other than those involved in the 'creation' of a lineage, are acting upon the exons and introns of protein-coding genes. These processes can distort phylogenetic information, thereby obscuring evolutionary histories and making it impossible to reconstruct genealogical relationships. Although these forces act on genes at all taxonomic levels, most problems are encountered at the deeper levels such as kingdom, family and order (10, 94, 123, 125, 166, 265, 292). Among closely related taxa at the species level a specific gene or part of a gene is generally subjected to comparable forces (55, 117, 166, 292).

### 3 SINGLE AND MULTI-COPY GENES

Evolutionary analyses are based on the assumption that the selected gene or region of the genome is orthologous (167). In other words, the evolutionary history for this region is similar to that of the individuals in which it is studied. Events that will create multiple copies of genes (duplication, hybridization and horizontal transfer) may result in non-orthology between genes. Protein coding genes that occur in multigene families and those that occur as single genes in the genome of an organism are further subjected to different evolutionary forces (217). The non-uniform evolutionary forces acting on single and multi-copy protein-coding genes greatly complicate their use in phylogenetic studies, since a gene phylogeny can be inaccurately interpreted as a species phylogeny.

#### 3.1 Multi-copy genes

##### 3.1.1 Types of multigene families

In evolutionary biology, the duplication events that gave rise to multigene families could have occurred very early or relatively recently. These ancient and recent duplication events are reflected in the degree of divergence from the ancestral gene. For example, modern gene families share a high degree of sequence homology, while ancient gene families show very little sequence homology. In many cases, the homology in ancient gene families will be restricted to a number of conserved domains, which is the result of functional constraint in the mature protein (28, 133). Examples of ancient multigene families are those that encode the different tubulin subunits of mature microtubules (174, 178) and those encoding the subunits of eukaryotic DNA-dependent RNA polymerases (133). Some of these ancient gene families are divided into subfamilies to form modern gene families.

Ancient multigene families are potentially of great use in evolutionary studies, especially for the inference of deep phylogenetic relationships. For this type of study, eukaryotic protein-coding genes are normally used. However, this approach is problematic, since suitable outgroups are not always available (107, 144). The problem can be overcome by using the gene sequence of another member of that ancient multigene family as an outgroup. This is, however, only possible when the duplication event that generated the gene family predated the divergence of the taxa of interest. This approach has been successfully employed by several research groups (107, 135, 144, 254).

Modern multigene families include those encoding  $\beta$ -tubulins (46), chitin synthases (29), actins (190), etc. The different members of some of these gene families are thought to be essential at different stages of the life cycles of organisms (38, 46, 80, 128, 129, 153, 190, 246, 259, 284). This is, however, not always the case, since disruption of genes in these families does not always



result in lethal mutations (38, 60, 266). It is suggested that the occurrence of more than one copy of a specific gene act as a form of multigene control of a specific trait, since another member of the family can 'replace' a defective copy (16, 301). The *rrn* genes also belong to the latter class of multigene families, despite the fact that they do not encode proteins.

Members of modern multigene families can occur clustered at a specific locus on a chromosome. For example, the genes encoding  $\alpha$ - and  $\beta$ -tubulin in some plants and metazoans are organized as tandem repeats on a chromosome (46, 231). They can also occur at multiple loci on more than one chromosome (13, 16, 46, 190, 303). Multigene families can, however, also consist of individual genes scattered across the genome. Examples of these are the genes encoding chitin synthases in oomycetous fungi (199) and actins in mammals (190).

### 3.1.2 Concerted evolution

Large-scale sequence analyses of the repeated genes constituting multigene families, have revealed that the members of a repeat, share more similarities within a species, than between species. This species-specific homogeneity is generated by a process known as 'concerted evolution' or 'molecular drive' (66, 311). There are several mechanisms through which this process can take place e.g. unequal crossing-over, gene conversion, homologous recombination, transposition and replication slippage. Gene conversion and unequal crossing-over are considered the most important of these mechanisms.

Concerted evolution is best explained by Sanderson and Doyle (240) using a simple gene family consisting of two members (X and Z) in each of four species (1, 2, 3, and 4) (Fig. 2A). X and Z are paralogous genes that originated from a duplication event, prior to the radiation of species 1 - 4. The X genes in all the individuals are orthologous and trace their ancestry to a speciation event. The same is also true for the Z genes. Phylogenetic reconstructions using either the X or the Z genes will thus reflect the organismal evolution. However, in most cases it is impossible to differentiate between homologous genes of paralogous and orthologous origins. In the absence of, or prior to, homogenization (Fig. 2B), all the X genes will form a cohesive cluster, as is true for Z genes. The lineage or species history within each of these clades, however, still reflect the 'correct' phylogeny as depicted in the 'true genealogy' (Fig. 2A). After concerted evolution, or when it is highly effective, all the paralogues within an individual are homogenized (Fig. 2C). In these cases, interspecies variation by far exceeds intraspecies variation. Clearly, reconstructing evolutionary relationships from genes that are subjected to high levels of homogenization and those where concerted evolution is effectively absent, are relatively straightforward (52, 293). Either orthologues will group together (Fig. 2B) or paralogues will be homogenized, but in both cases it would be possible to infer the 'correct' phylogeny. However, intermediate levels of concerted

evolution introduces major complications to the inference of evolutionary relationships (183, 184, 240).

The mechanisms through which concerted evolution take place do not exclude the potential for 'horizontal' spread of a variant member (8, 66, 67, 120, 167). This is especially true when the variant carries a beneficial mutation. This mutation can then be spread to all the other members of that family, thus illustrating how a small selective advantage can become a great advantage via concerted evolution (167). Since this type of mutation is not acquired through descent from a common origin, many authors conclude that concerted evolution conceals true phylogenetic relationships (117, 234, 240, 293). The effect of concerted evolution can be summarized most appropriately in the words of Schimenti (244) who states that "concerted evolution can wipe out millions of years of divergence" or "introduce multiple sequence changes into a member of a gene family...in a single event".

The efficacy of concerted evolution to homogenize paralogous genes throughout in the genome varies greatly. In cotton (*Gossypium* spp.), for example, different gene families are subjected to different levels of concerted evolution. Cronn et al. (52) showed that all the members of the cotton 5S *rrn* family at one locus were very similar in sequence and different from the copies at another locus. These results were in contrast to those of Wendel et al. (293) using the cotton 18S-26S *rrn* multigene family. They showed that all the sequenced copies of the 18S-26S repeat, whether from a single or more than one locus, had almost identical sequences. Variations in the degree of homogenization thus occur not only among multigene families, but also among different clusters of the same gene family (19, 52, 69, 70, 90, 114, 127, 151, 189, 234, 274, 293). Although the majority of studies on the efficacy of concerted evolution focused on the homogenization of *rrn* genes, the homogenization of protein-coding gene families is well documented (1, 47, 81, 113, 114, 117, 127, 151, 234, 272, 274).

### **3.1.3 Example of a protein encoded by a multigene family: $\beta$ -tubulin**

Inspection of the sequences in nucleotide databases such as GenBank reveals that many different protein-coding genes are currently used to address evolutionary and taxonomic issues in diverse organisms (Table 2). The most entries for fungi are those encoding  $\beta$ -tubulin, translation elongation factor 1 $\alpha$ , chitin synthases, actin and glyceraldehyde-3-phosphate dehydrogenase. The nucleotide databases for the genes encoding calmodulin, the mating type idiomorphs and histone H3 are also relatively large. Although the genes encoding other proteins, such as translation elongation factor 2, HSP70 and  $\alpha$ -tubulin are less frequently used by fungal taxonomists, they have been successfully used in many other lower eukaryotes (Table 2). However, after the *rrn* genes, the use of those encoding  $\beta$ -tubulin in fungi is best documented.

$\beta$ -Tubulin is one of the 50-kDa subunits of the heterodimeric protein, tubulin (46, 266). Tubulin is the primary component of microtubules, which are the cytoskeletal filaments of eukaryotic cells. For this reason, they are involved in determining the shape the cell and the nucleus, as well as, as well as in cell processes such as chromosome segregation, cell division, flagellar motility, etc. (46, 266).

From agricultural and veterinary perspectives,  $\beta$ -tubulin is an important protein. This is mainly due to the mode of action of benzimidazole containing fungicides and anthelmintics (54). These drugs specifically bind to  $\beta$ -tubulin, thereby preventing the assembly of mature microtubules and result in the inhibition of DNA synthesis (54). Single point mutations in the gene encoding  $\beta$ -tubulin have been shown to confer resistance to benzimidazoles (7, 16, 37, 150, 220, 266, 302, 304). Although only one of the  $\beta$ -tubulin-coding loci is usually associated with benzimidazole sensitivity or resistance, more loci can sometimes be involved (16, 266).

$\beta$ -Tubulin is usually encoded by highly conserved multigene families or in some cases single genes. In the best-studied higher plants, multigene families consisting of five to nine different  $\beta$ -tubulin genes have been described (108, 128, 168, 181). Similar multigene families in animals have been reported (46, 266). Some fungi also appear to have more than one divergent copy of the  $\beta$ -tubulin gene. *Saccharomyces cerevisiae* (202), *Candida albicans* (257), *Neurospora crassa* (220), *Schizosaccharomyces pombe* (121), *Botrytis cinerea* (304) and *Fusarium* species in the *Gibberella fujikuroi* complex (212) all appear to have a single copy of this gene. On the other hand, fungi such as *Geotrichum candidum* (101), *Aspergillus nidulans* (187), *Colletotrichum gleosporioides* f. sp. *aeschynomene* (37), *C. graminicola* (222), *Erisiphe graminis* (252), *Acremonium coenophialum* (278) and species in the *F. solani* complex (212) have at least two different copies of the  $\beta$ -tubulin gene.

The  $\beta$ -tubulin gene sequence provides an excellent tool for studying phylogenetic relationships at all taxonomic levels. This protein-coding gene has been successfully used to determine both intra- and interspecific relationships. An example where  $\beta$ -tubulin gene sequences have been used at the intra-species level is in populations of the sheep gut parasite, *Haemonchus contortus* (16). A well-known example where it has been used at the interspecies level is for the molecular characterization of *Fusarium* species (5, 213, 216).  $\beta$ -Tubulin gene sequences have also been used to address deep phylogeny questions. The best example is probably where this gene, together with three other protein-coding genes, was used to demonstrate that fungi and animals are each other's closest relatives (11).

### 3.2 Single copy genes

Divergence of a single copy gene and speciation are two very close linked processes. This is because divergence of an ancestral gene would coincide with speciation. A single copy gene would be more 'resistant' to mutations than members of a multigene family. A lethal mutation in one of the members of multigene family can be 'corrected' through concerted evolution. If concerted evolution fails to 'correct' the mutation, another member of the multigene family can take on the role of the mutated gene (38, 301). A lethal mutation in a single copy gene, however, results in death of the individual (202, 218). For this reason, non-lethal nucleotide changes in a single copy gene will also cause changes in the individual, thus contributing to species evolution. Therefore, a single-copy gene would theoretically provide more reliable evolutionary reconstructions than multi-copy genes (163).

Most protein-coding genes used for reconstructing phylogenetic histories, occur as multigene families (Table 2). Some of them, however, also occur as single copy genes in lower eukaryotes such as actin genes in certain algae, protozoans and oomycetous fungi (19, 68, 71). The only protein-coding genes that apparently occur 'universally' as single copies, are those encoding the largest and the second largest subunits (*RPB1* and *RPB2*) of the DNA dependent RNA polymerase II complex (56, 170, 254). This may, however, be because of under-sampling, since the copy numbers of these genes are seldom determined.

#### 3.2.1 Examples of proteins encoded by single genes: largest and second largest subunits of DNA-dependent RNA polymerase II

RNA polymerase is thought to be one of the earliest enzymes to have appeared (161). This is consistent with the idea that RNA preceded DNA as genetic material. This ancient RNA-dependent RNA polymerase then gave rise to the modern DNA-dependent RNA and DNA polymerases (161). The eukaryotic DNA-dependent RNA polymerases are large multi-subunit enzyme complexes that are divided into three groups, i.e. RNA polymerase I, II and III (289). RNA polymerase I is responsible for transcription of the 5.8S, 18S and 28S *rrn* genes, RNA polymerase II transcribes nuclear protein-coding genes into mRNA and RNA polymerase III produces tRNA and 5S ribosomal RNA (289).

The eukaryotic DNA-dependent RNA polymerases share a common origin with the eubacterial and archaeobacterial RNA polymerases (133). Because of this, the genes encoding their protein-subunits closely resemble one another. For example, the genes encoding the largest subunits of the eukaryotic RNA polymerase I, II and III are homologous to the eubacterial  $\beta'$  subunit (133). This homology is reflected in the nine conserved domains (I-IX) present in these prokaryotic and eukaryotic genes.



Many researchers have indicated the potential use of the genes encoding DNA-dependent RNA polymerase subunits in evolutionary studies (133, 161, 227, 254). A number of sequences for the genes encoding the two largest subunits of RNA polymerase II are available (Table 2). However, few sequences encoding the subunits of RNA polymerase I and III are available, making them less suitable for evolutionary analyses.

The largest subunit of the RNA polymerase II is encoded by the gene, *RPB1*, and the second largest subunit is encoded by *RPB2* (306). The GenBank nucleotide database for both these genes is limited compared to those for other genes (Table 2), but several successes have recently been reported on using *RPB1* and *RPB2* gene sequences for evolutionary studies (51, 56, 123, 170). Liu et al. (170) showed that *RPB2* is more useful than 18S *rrn* to resolve the relationships among the different fungal orders. Croan et al. (51) showed that *RPB1* is useful for studying interspecific relationships among *Leishmania* species. Furthermore, both these genes provide good resolution at deeper phylogenetic levels. Denton et al. (56) reconstructed the possible phylogeny of the plant kingdom (viridiplantae) using *RPB2* gene sequence and Hirt et al. (123) placed the microsporidia within the fungal kingdom using *RPB1* gene sequence.

## 4 PROTEIN-CODING GENES AND FUNGAL TAXONOMY

In recent years, protein-coding genes have increasingly been used to address phylogenetic and taxonomic questions at all levels. These sequences have not only proven useful at deeper (Kingdom or Division) taxonomic levels, but also at the lower (inter- and intraspecies) levels (Table 2). Several protein-coding genes contain sufficiently variable and conserved regions to allow resolution at both deeper and lower taxonomic levels (Table 2). Most of the recent advances in fungal taxonomy have, therefore, been based on sequence for protein-coding genes.

### 4.1 Deep level fungal taxonomy: The microsporidia-fungi relationship

Microsporidia are spore forming obligate intracellular parasites of all major animal groups (41, 44). Although they represent an eukaryotic lineage, the microsporidia share a surprising number of features with prokaryotes. These include ribosomal features such as 70S rather than 80S ribosomes and fused 5.8S and large subunit *rrn* genes (287). The microsporidian genomes also correspond with those of bacteria, as they are small and rarely harbor introns (21, 83, 141). The microsporidia also lack eukaryotic organelles such as mitochondria (44, 141). Because of this resemblance to prokaryotes, they were thought to represent eukaryotic lineages that evolved prior to the acquisition of mitochondria. They were consequently classified as Archezoa (44, 286).

The archezoan status of the microsporidia has been supported by molecular data from the

*rrn* genes and those encoding the translation elongation factors, EF-1 $\alpha$  and EF-2 (139, 286). In the microsporidian lineage, however, these genes are known to display features such as biased base composition, unique insertions and deletions and accelerated rates of substitution (145). Phylogenies based on these genes were thus not reliable (145, 226, 265), which resulted in the erroneous placement of the microsporidia at the base of the eukaryotic tree (20, 75, 82, 122, 123, 144, 145).

Phylogenies based on  $\alpha$ -,  $\beta$ -, and  $\gamma$ -tubulin gene sequences indicated that the microsporidia are closely related to the fungi. Keeling et al. (145) further showed that the microsporidia evolved from within the fungal group, sometime after the divergence of the chitrids. The idea that the microsporidia are phylogenetically nested within the fungal kingdom is also supported by the recent discovery of functional spliceosomal introns (20, 83). Evidence that this group of organisms once contained mitochondria (122) also supported this finding. It thus appears that the microsporidia are a highly specialized fungal lineage that 'lost' many of their eukaryotic features during adaptation to the intracellular parasitic lifestyle (20, 83, 145).

The discovery of the fungal heritage of microsporidia serves as just one example where protein-coding sequences have been used to determine the phylogenetic position of an evolutionarily ancient group of organisms. There are several other examples where these sequences have been useful in reconstructing the evolutionary histories of ancient lineages (141-143). The microsporidian example further shows that not all protein-coding genes are equally suited to address phylogenetic questions, at all levels. In this fungal lineage, the genes encoding the translation elongation factors were apparently too variable, which resulted in distorted genealogies. These genes have, however, proven useful in other fungal lineages (214, 216).

## **4.2 Low-level fungal taxonomy**

### **4.2.1 Interspecific relationships**

One of the best examples of a protein-coding gene being used to elucidate the relationships among closely related species is found in the work of O'Donnell et al. (212, 213). They studied the relationships among *Fusarium* species in the *Gibberella fujikuroi* complex using  $\beta$ -tubulin gene sequences. The fungi in this complex include well-known pathogens of many important agricultural plants (164, 165). Their classification has been hampered by the fact that they are morphologically very similar (26, 93, 204, 209).

In the taxonomy of *Fusarium* species belonging to the *G. fujikuroi* complex, the use of ribosomal ITS regions has proven to be problematic (212, 213). This is because they harbor non-orthologous divergent homologues of the ITS2 region that appears to have escaped concerted evolution (212, 213). Apparently, these homologues were the result of an interspecific

hybridization (xenologous origin) or gene duplication (paralogous origin) event. This event occurred prior to the radiation of species in this complex.

The phylogenetic relationships among the *Fusarium* species in this complex have been resolved using  $\beta$ -tubulin gene sequences (212, 213). What was thought to be three to eight species based on morphology, turned out to be more than 30 distinct *Fusarium* spp. (212, 214, 216). These results have also been confirmed using other protein-coding gene sequences, as well as morphological characters (33, 126, 164, 209, 263). Additionally, these protein-coding sequences have formed the basis for diagnostic techniques to identify members of this economically important group of plant pathogens (263).

#### 4.2.2 Intraspecific relationships

Characterization of the intraspecific relationships among different groups of fungi is extremely important to fungal taxonomists. Because many fungi are asexual, their populations often constitute clones. The classification of these clones becomes increasingly important when they are associated with the production of mycotoxins or when they are serious plant and human pathogens (5, 42, 92, 154, 214, 270). The classification of the clonal and recombining lineages in the aflatoxin producing fungus, *Aspergillus flavus*, is one such an example. Using various protein-coding genes, Geiser et al. (92) showed that this apparently asexual fungus is separated into groups that correspond with their ability to produce toxin. Protein-coding gene sequences are thus valuable tools for identifying and classifying clonal or asexual, as well as recombining fungal lineages (42, 74, 92).

The review of the use of protein-coding genes to study the intraspecific relationships among populations of fungi would not be complete without reference to their value in detecting interpopulation-recombination events. A simple method, known as 'gene-gene concordance', was suggested to detect these recombination events (73, 74, 188, 299). Gene-gene concordance assesses the congruence between the phylogenetic trees constructed using several different genes. If concordant trees are obtained from all the genes tested, it is concluded that recombination among the individuals tested is rare. They thus represent clonal populations. If the gene trees for the group of individuals in question differ, recent recombination events among these individuals will have occurred. Although 'gene-gene concordance' is a relatively recent introduction to fungal taxonomy and population genetics, several authors have been able to detect sexual and asexual fungal lineages using this approach (39, 92, 154, 270, 271).

## 5 CONCLUSIONS

Fungal taxonomy has entered an exciting era, especially when taking into account that it is possible to reconstruct the evolutionary history of any group of individuals by using many different genes. In this way, many problems associated with traditional classification (for example morphological crypsis) have been or are in the process of being resolved using DNA sequence information from protein-coding genes. This is especially true in cases where the *rrn* genes and ITS regions display insufficient variability or where lineages are in the process of divergence. Consequently, the available nucleotide information on many different protein-coding genes in public domain databases is expanding continuously. Already, considerable collections of sequence data for proteins are available for important fungal lineages such as *Fusarium* and *Aspergillus*. In the future, these sequences will undoubtedly form the basis for DNA-based identification techniques and classification systems.

## 6 REFERENCES

1. **Alonso, S., A. Minty, Y. Bourlet, and M. Buckingham.** 1986. Comparison of three actin-coding sequences in the mouse; evolutionary relationships between the actin genes of warm-blooded vertebrates. *J. Mol. Evol.* **23**:11-22.
2. **Alvarez, F., M. N. Cortinas, and H. Musto.** 1996. The analysis of protein coding genes suggests monophyly of *Trypanosoma*. *Mol. Phylogenet. Evol.* **5**:333-343.
3. **Amegadzie, B. Y., R. S. Zitomer, and C. P. Hollenberg.** 1990. Characterization of the cytochrome c gene from the starch-fermenting yeast *Schwanniomyces occidentalis* and its expression in baker's yeast. *Yeast.* **6**:429-440.
4. **An, S. S., B. Mopps, K. Weber, and D. Bhattacharya.** 1999. The origin and evolution of green algal and plant actins. *Mol. Biol. Evol.* **16**:275-285.
5. **Aoki, T., and K. O'Donnell.** 1999. Morphological and molecular characterization of *Fusarium pseudograminearum* sp. nov., formerly recognized as the Group 1 population of *F. graminearum*. *Mycologia.* **91**:597-609.
6. **Apoil, P.-A., and A. Blancher.** 2000. *Rh* gene evolution in primates: study of intron sequences. *Mol. Biol. Evol.* **17**:127-136.
7. **Armstrong, J. L., and D. L. Harris.** 1993. Biased DNA integration in *Colletotrichum gloeosporioides* f. sp. *aeschynomene* transformants with benomyl resistance. *Phytopathology.* **83**:328-332.
8. **Arnheim, N.** 1983. Concerted evolution of multigene families, p. 38-61. *In* M. Nei and R. K. Koehn (ed.), *Evolution of genes and proteins*. Sinauer Associates, Inc., Sunderland, Massachusetts.
9. **Bagavathi, S., and R. Malathi.** 1996. Introns and protein evolution - an analysis of the exon/intron organization of actin genes. *FEBS Lett.* **392**:63-65.
10. **Baldauf, S. L., and W. F. Doolittle.** 1997. Origin and evolution of the slime molds (Mycetozoa). *Proc. Natl. Acad. Sci. USA.* **94**:12007-12012.
11. **Baldauf, S. L., and J. D. Palmer.** 1993. Animals and fungi each other's closest relatives: congruent evidence from multiple proteins. *Proc. Natl. Acad. Sci. USA.* **90**:11558-11562.
12. **Baldo, A. M., D. H. Les, and L. D. Strausbaugh.** 1999. Potentials and limitations of histone repeat sequences for phylogenetic reconstruction of *Sophophora*. *Mol. Biol. Evol.* **16**:1511-1520.
13. **Bannon, G. A., J. K. Bowen, M.-C. Yoa, and M. A. Gorovsky.** 1984. *Tetrahymena* H4 genes: structure, evolution and organization in macro- and micronuclei. *Nucleic Acids Res.*





14. **Barderi, P., O. Campetella, A. C. C. Frasc, J. Santome, U. Hellman, U. Pettersson, and J. J. Cazzulo.** 1998. The NADP<sup>+</sup>-linked glutamate dehydrogenase from *Trypanosoma cruzi*: sequence, genomic organization and expression. *Biochem. J.* **330**:951-958.
15. **Barron-Casella, E., and J. L. Corden.** 1992. Conservation of the mammalian RNA polymerase II largest-subunit C-terminal domain. *J. Mol. Evol.* **35**:405-410.
16. **Beech, R. N., R. K. Prichard, and M. E. Scott.** 1994. Genetic variability of the  $\beta$ -tubulin genes in benzimidazole-susceptible and -resistant strains of *Haemonchus contortus*. *Genetics.* **138**:103-110.
17. **Belfort, M., and P. S. Perlman.** 1995. Mechanism of intron mobility. *J. Biol. Chem.* **270**:30237-30240.
18. **Berbee, M. L., M. Pirseyedi, and S. Hubbard.** 1999. *Cochliobolus* phylogenetics and the origin of known, highly virulent pathogens, inferred from ITS and glyceraldehyde-3-phosphate dehydrogenase gene sequences. *Mycologia.* **91**:964-977.
19. **Bhattacharya, D., S. K. Stickel, and M. L. Sogin.** 1991. Molecular phylogenetic analysis of actin gene regions for *Achlya bisexualis* (Oomycota) and *Costaria costata* (Chromophyta). *J. Mol. Evol.* **33**:525-536.
20. **Biderre, C., G. Méténier, and C. P. Vivarès.** 1998. A small spliceosomal-type intron occurs in a ribosomal protein gene of the microsporidian *Encephalitozoon cuniculi*. *Mol. Biochem. Parasitol.* **94**:283-286.
21. **Biderre, C., M. Pagès, G. Méténier, E. U. Canning, and C. P. Vivarès.** 1995. Evidence for the smallest nuclear genome (2.9 Mb) in the microsporidium *Encephalitozoon cuniculi*. *Mol. Biochem. Parasitol.* **74**:229-231.
22. **Blake, C. C. F.** 1978. Do genes-in-pieces imply proteins-in-pieces? *Nature.* **273**:267.
23. **Blake, C. C. F.** 1983. Exons - present from the beginning? *Nature.* **306**:535-537.
24. **Blake, C. C. F.** 1985. Exons and the evolution of proteins. *Int. Rev. Cytol.* **93**:149-185.
25. **Blake, C. C. F.** 1979. Exons encode protein functional units. *Nature.* **277**:598.
26. **Booth, C.** 1971. The genus *Fusarium*. Commonwealth Agricultural Bureau, Bucks, England.
27. **Borchiellini, C., N. Boury-Esnault, J. Vacelet, and Y. Le Parco.** 1998. Phylogenetic analysis of the Hsp70 sequences reveals the monophyly of metozoa and specific phylogenetic relationships between animals and fungi. *Mol. Biol. Evol.* **15**:647-655.
28. **Bork, P., C. Sander, and A. Valencia.** 1992. An ATPase domain common to prokaryotic cell cycle proteins, sugar kinases, actin, and hsp70 heat shock proteins. *Proc. Natl. Acad. Sci. USA.* **89**:7290-7294.
29. **Bowen, A. R., J. L. Chen-Wu, M. Momany, R. Young, P. J. Szaniszlo, and P. W.**

- Robbins.** 1992. Classification of fungal chitin synthase. *Proc. Natl. Acad. Sci. USA.* **89**:519-523.
30. **Bradnam, K. R., C. Seoighe, P. M. Sharp, and K. H. Wolfe.** 1999. G+C content variation along and among *Saccharomyces cerevisiae* chromosomes. *Mol. Biol. Evol.* **16**:666-675.
31. **Breathnach, R., and R. Chambon.** 1981. Organization and expression of eukaryotic split genes coding for proteins. *Annu. Rev. Biochem.* **50**:349-383.
32. **Brinkman, H., P. Martinez, F. Quigley, W. Martin, and R. Cerff.** 1987. Endosymbiotic origin and codon bias of the nuclear gene for chloroplast glyceraldehyde-3-phosphate dehydrogenase from maize. *J. Mol. Evol.* **26**:320-328.
33. **Britz, H., T. A. Coutinho, M. J. Wingfield, W. F. O. Marasas, T. R. Gordon, and J. F. Leslie.** 1999. *Fusarium subglutinans* f. sp. *pini* represents a distinct mating population in the *Gibberella fujikuroi* species complex. *Appl. Environ. Microbiol.* **65**:1198-1201.
34. **Brown, W. M., E. M. Prager, A. Wang, and A. C. Wilson.** 1982. Mitochondrial DNA sequences of primates: tempo and mode of evolution. *J. Mol. Evol.* **18**:225-239.
35. **Bruns, T. D., T. J. White, and J. W. Taylor.** 1991. Fungal molecular systematics. *Annu. Rev. Ecol. Syst.* **22**:525-564.
36. **Brynnel, E. U., C. G. Kurland, N. A. Moran, and S. G. E. Andersson.** 1998. Evolutionary rates for *tuf* genes and endosymbionts of aphids. *Mol. Biol. Evol.* **15**:574-582.
37. **Buhr, T. L., and M. B. Dickman.** 1994. Isolation, characterization, and expression of a second  $\beta$ -tubulin-encoding gene from *Colletotrichum gloeosporioides* f.sp. *aeschynomene*. *Appl. Environ. Microbiol.* **60**:4155-4159.
38. **Bulawa, C. E.** 1993. Genetics and molecular biology of chitin synthesis in fungi. *Annu. Rev. Microbiol.* **47**:505-534.
39. **Burt, A., D. A. Carter, G. L. Koenig, T. J. White, and J. W. Taylor.** 1996. Molecular markers reveal cryptic sex in the human pathogen *Coccidioides immitis*. *Proc. Natl. Acad. Sci. USA.* **93**:770-773.
40. **Bussink, H. J., F. P. Buxton, B. A. Fraaye, L. H. de Graaff, and J. Visser.** 1992. The polygalacturonases of *Aspergillus niger* are encoded by a family of diverged genes. *Eur. J. Biochem.* **208**:83-90.
41. **Canning, E. U.** 1990. Phylum Microsporida, p. 53-72. *In* L. Margulis, J. O. Corliss, M. Melkonian, and D. J. Chapman (ed.), *Handbook of Protoctista*. Jones and Bartlett Publishers, Boston.
42. **Carbone, I., J. B. Anderson, and L. M. Kohn.** 1999. Patterns of descent in clonal lineages and their multilocus fingerprints are resolved with combined gene genealogies. *Evolution.* **53**:11-21.

43. **Cavalier-Smith, T.** 1991. Intron phylogeny: a new hypothesis. *Trends Genet.* **7**:145-148.
44. **Cavalier-Smith, T.** 1993. Kingdom Protozoa and its 18 Phyla. *Microbiol. Rev.* **57**:953-994.
45. **Christiansen, S. K., A. F. Justensen, and H. Giëse.** 1997. Disparate sequence characteristics of the *Erysiphe graminis* f. sp. *hordei* glyceraldehyde-3-phosphate dehydrogenase gene. *Curr. Genet.* **31**:525-529.
46. **Cleveland, D. W., and K. F. Sullivan.** 1985. Molecular biology and genetics of tubulin. *Annu. Rev. Biochem.* **54**:331-365.
47. **Coen, E., T. Strachan, and G. Dover.** 1982. Dynamics of concerted evolution of ribosomal DNA and histone gene families in the *melanogaster* species subgroup of *Drosophila*. *J. Mol. Biol.* **158**:17-35.
48. **Colgan, D. J.** 1999. Phylogenetic studies of marsupials based on phosphoglycerate kinase DNA sequences. *Mol. Phylogenet. Evol.* **11**:13-26.
49. **Comeron, J. M., and M. Kreitman.** 1998. The correlation between synonymous and nonsynonymous substitutions in *Drosophila*: mutation, selection or relaxed constraints? *Genetics.* **150**:767-775.
50. **Copertino, D. W., and R. B. Hallick.** 1993. Group II and group III introns of twintrons: potential relationships with nuclear pre-mRNA introns. *Trends Biochem. Sci.* **18**:467-471.
51. **Croan, D. G., D. A. Morrison, and J. T. Ellis.** 1997. Evolution of the genus *Leishmania* revealed by comparison of DNA and RNA polymerase gene sequences. *Mol. Biochem. Parasitol.* **89**:149-159.
52. **Cronn, R. C., X. Zhao, A. H. Paterson, and J. F. Wendel.** 1996. Polymorphism and concerted evolution in a tandemly repeated gene family: 5S ribosomal DNA in diploid and allopolyploid cottons. *J. Mol. Evol.* **42**:685-705.
53. **Danforth, B. N., H. Sauquet, and L. Packer.** 1999. Phylogeny of the bee genus *Halictus* (Hymenoptera:Halictidae) based on parsimony and likelihood analyses of nuclear elongation factor-1 $\alpha$  sequence data. *Mol. Phylogenet. Evol.* **13**:605-618.
54. **Davidse, L. C.** 1986. Benzimidazole fungicides: mechanism of action and biological impact. *Annu. Rev. Phytopathol.* **24**:43-65.
55. **De los Angeles Barriga Sosa, I., K. Beckenbach, B. Hartwick, and M. J. Smith.** 1995. The molecular phylogeny of five Eastern and North Pacific octopus species. *Mol. Phylogenet. Evol.* **4**:163-174.
56. **Denton, A. L., B. L. McConaughy, and B. D. Hall.** 1998. Usefulness of RNA polymerase II coding sequences for estimation of green plant phylogeny. *Mol. Biol. Evol.* **15**:1082-1085.
57. **DeSalle, R., T. Freedman, E. M. Prager, and A. C. Wilson.** 1987. Tempo and mode of



- sequence evolution in mitochondrial DNA of Hawaiian *Drosophila*. *J. Mol. Evol.* **26**:157-164.
58. **Dibb, N. J., and A. J. Newman.** 1989. Evidence that introns arose at proto-splice sites. *EMBO J.* **8**:2015-2021.
59. **Dietmaier, W., and S. Fabry.** 1994. Analysis of the introns in genes encoding small G proteins. *Curr. Genet.* **26**:497-505.
60. **Din, A. B., and O. Yarden.** 1994. The *Neurospora crassa chs-2* gene encodes a non-essential chitin synthase. *Microbiology.* **140**:2189-2197.
61. **Dix, D. B., and R. C. Thompson.** 1989. Codon choice and gene expression: synonymous codons differ in translational accuracy. *Proc. Natl. Acad. Sci. USA.* **86**:6888-6892.
62. **Dohmen, R. J., A. W. M. Strasser, U. M. Dahlems, and C. P. Hollenberg.** 1990. Cloning of the *Schwanniomyces occidentalis* glucoamylase gene (*GAMI*) and its expression in *Saccharomyces cerevisiae*. *Gene.* **95**:111-121.
63. **Donaldson, G. C., L. A. Ball, P. E. Axelrood, and N. L. Glass.** 1995. Primer sets developed to amplify conserved genes from filamentous ascomycetes are useful in differentiating *Fusarium* species associated with conifers. *Appl. Environ. Microbiol.* **61**:1331-13340.
64. **Doolittle, R. F.** 1995. The multiplicity of domains in proteins. *Annu. Rev. Biochem.* **64**:287-314.
65. **Doolittle, W. F.** 1987. The origin and function of intervening sequences in DNA: a review. *Am. Nat.* **130**:915-928.
66. **Dover, G.** 1982. Molecular drive: a cohesive mode of species evolution. *Nature.* **299**:111-117.
67. **Dowling, T. E., C. Moritz, and J. D. Palmer.** 1990. Nucleic Acids II. Restriction site analysis, p. 250-317. *In* D. M. Hillis and C. Moritz (ed.), *Molecular Systematics*. Sinauer Associates, Inc., Sunderland, Massachusetts.
68. **Drouin, G., M. M. De Sa, and M. Zuker.** 1995. The *Giardia lamblia* actin gene and the phylogeny of eukaryotes. *J. Mol. Evol.* **41**:841-849.
69. **Drouin, G., and G. A. Dover.** 1990. Independent gene evolution in the potato actin gene family demonstrated by phylogenetic procedures for resolving gene conversions and the phylogeny of angiosperm actin genes. *J. Mol. Evol.* **31**:132-150.
70. **Drouin, G., F. Prat, M. Ell, and G. D. P. Clarke.** 1999. Detecting and characterizing gene conversion between multigene family members. *Mol. Biol. Evol.* **16**:1369-1390.
71. **Dudler, R.** 1990. The single-copy actin gene of *Phytophthora megasperma* encodes a protein considerably diverged from any other actin. *Plant Mol. Biol.* **14**:415-422.

72. **Dujon, B.** 1989. Group I introns as mobile genetic elements: facts and mechanistic speculations - a review. *Gene*. **82**:91-114.
73. **Dykhuisen, D. E., and L. Green.** 1991. Recombination in *Escherichia coli* and the definition of biological species. *J. Bacteriol.* **173**:7257-7268.
74. **Dykhuisen, D. E., D. S. Polin, J. J. Dunn, B. Wilske, V. Preac-Mursic, R. J. Dattwyler, and B. J. Luft.** 1993. *Borrelia burgdorfi* is clonal: Implications for taxonomy and vaccine development. *Proc. Natl. Acad. Sci. USA.* **90**:10163-10167.
75. **Edlind, T. D., J. Li, G. S. Visvesvara, M. H. Vodkin, G. L. McLaughlin, and S. K. Katiyar.** 1996. Phylogenetic analysis of  $\beta$ -tubulin sequences from amitochondrial protozoa. *Mol. Phylogenet. Evol.* **5**:359-367.
76. **Eggert, C., P. LaFayette, U. Temp, K.-E. L. Eriksson, and J. F. D. Dean.** 1998. Molecular analysis of a laccase gene from the white rot fungus *Pycnoporus cinnabarinus*. *Appl. Environ. Microbiol.* **64**:1766-1772.
77. **Embley, T. M., and R. P. H. Hirt.** 1998. Early branching eukaryotes? *Curr. Opin. Genet. Dev.* **8**:624-629.
78. **Engelberg-Kulka, H., I. Benhar, and R. Schoulaker-Schwarz.** 1993. Translational introns: an additional regulatory element in gene expression. *Trends Biochem. Sci.* **18**:294-296.
79. **Fabry, S., K. Muller, A. Lindauer, P. B. Park, T. Cornelius, and R. Schmitt.** 1995. The organization structure and regulatory elements of *Chlamydomonas* histone genes reveal features linking plant and animal genes. *Curr. Genet.* **28**:333-345.
80. **Fackenthal, J. D., F. R. Turner, and E. Raff.** 1993. Tissue-specific microtubule functions in *Drosophila* spermatogenesis require the B2-tubulin isotype-specific carboxy terminus. *Dev. Biol.* **158**:213-227.
81. **Fang, H., and B. P. Brandhorst.** 1994. Evolution of actin gene families of sea urchins. *J. Mol. Evol.* **39**:347-356.
82. **Fast, N. M., J. M. Logsdon Jr, and W. F. Doolittle.** 1999. Phylogenetic analysis of the TATA box binding protein (TBP) gene from *Nosema locustae*: evidence for a Microsporidia-fungal relationship and spliceosomal intron loss. *Mol. Biol. Evol.* **16**:1415-1419.
83. **Fast, N. M., A. J. Roger, C. A. Richardson, and W. F. Doolittle.** 1998. U2 and U6 snRNA genes in the microsporidian *Nosema locustae*: evidence for a functional spliceosome. *Nucleic Acids Res.* **26**:3202-3027.
84. **Figge, R. M., M. Schubert, H. Brinkmann, and R. Cerff.** 1999. Glyceraldehyde-3-phosphate dehydrogenase gene diversity in eubacteria and eukaryotes: evidence for intra-

- and inter-kingdom gene transfer. *Mol. Biol. Evol.* **16**:429-440.
85. **Fink, G. R.** 1987. Pseudogenes in Yeast? *Cell.* **49**:5-6.
  86. **Fitch, W. M.** 1976. The molecular evolution of cytochrome c in eukaryotes. *J. Mol. Evol.* **8**:13-40.
  87. **Fletcher, L., J. M. McDowell, R. R. Tidwell, R. B. Meagher, and C. C. Dykstra.** 1994. Structure, expression and phylogenetic analysis of the gene encoding actin I in *Pneumocystis carinii*. *Genetics.* **137**:743-750.
  88. **Friendewey, D., and W. Keller.** 1985. Stepwise assembly of a pre-mRNA splicing complex requires U-snRNPs and specific intron sequences. *Cell.* **42**:355-367.
  89. **Fukami-Kobayashi, K., M. Nosaka, A. Nakazawa, and M. Gō.** 1996. Ancient divergence of long and short isoforms of adenylate kinase: molecular evolution of the nucleoside monophosphate kinase family. *FEBS Lett.* **385**:214-220.
  90. **Ganley, A. R. D., and B. Scott.** 1998. Extraordinary ribosomal spacer length heterogeneity in a Neotyphodium endophyte hybrid: Implications for concerted evolution. *Genetics.* **150**:1625-1637.
  91. **Garcia-Valve, S., J. Palau, and A. Romeu.** 1999. Horizontal gene transfer in glycosyl hydrolases inferred from codon usage in *Escherichia coli* and *Bacillus subtilis*. *Mol. Biol. Evol.* **16**:1125-1134.
  92. **Geiser, D. M., J. I. Pitt, and J. W. Taylor.** 1998. Cryptic speciation and recombination in the aflatoxin-producing fungus *Aspergillus flavus*. *Proc. Natl. Acad. Sci. USA.* **95**:388-393.
  93. **Gerlach, W., and H. I. Nirenberg.** 1982. The genus *Fusarium* - A pictorial atlas. *Mitt. Biol. Bundesanst. Land-Forstw. Berlin-Dahlem.* **209**:1-406.
  94. **Germot, A., H. Philippe, and H. Le Guyader.** 1997. Evidence for loss of mitochondria in Microsporidia from a mitochondrial-type HSP70 in *Nosema locustae*. *Mol. Biochem. Parasitol.* **87**:159-168.
  95. **Giardina, P., G. Palmieri, A. Scaloni, B. Fontanell, V. Faraco, G. Cennamo, and G. Sannia.** 1999. Protein and gene structure of a blue laccase from *Pleurotus ostreatus*. *Biochem. J.* **341**:655-663.
  96. **Gilbert, W.** 1987. The exon theory of genes. *Cold Spring Harbor Symp. Quant. Biol.* **52**:901-905.
  97. **Gilbert, W.** 1978. Why genes in pieces? *Nature.* **271**:501.
  98. **Gilbert, W., M. Marchionni, and G. McKnight.** 1986. On the antiquity of introns. *Cell.* **46**:151-154.
  99. **Gō, M., and M. Nosaka.** 1987. Protein architecture and the origin of introns. *Cold Spring Harbor Symp. Quant. Biol.* **52**:915-924.

100. **Gojobori, T., E. N. Moriyama, and M. Kimura.** 1990. Statistical methods for estimating sequence divergence. *Meth. Enzymol.* **183**:331-351.
101. **Gold, S. E., W. L. Casale, and N. T. Keen.** 1991. Characterization of two  $\beta$ -tubulin genes from *Geotrichum candidum*. *Mol. Gen. Genet.* **230**:104-112.
102. **Gonzales, P., G. Barroso, and J. Labarere.** 1998. Molecular analysis of the split *cox1* gene from the Basidiomycota *Agrocybe aegerita*: relationships of its introns with homologous Ascomycota introns and divergence levels from common ancestral copies. *Gene.* **220**:45-53.
103. **Gouy, M., and C. Gautier.** 1982. Codon usage in bacteria: correlation with gene expressivity. *Nucleic Acids Res.* **10**:7055-7074.
104. **Grabowski, P. J., S. R. Seiler, and P. A. Sharp.** 1985. A multicomponent complex is involved in the splicing of messenger RNA precursors. *Cell.* **42**:345-353.
105. **Grandy, D. K., and J. B. Dodgson.** 1987. Structure and organization of the chicken H2B histone gene family. *Nucleic Acids Res.* **15**:1063-1080.
106. **Grantham, R., C. Gautier, M. Gouy, R. Mercier, and A. Pave.** 1980. Codon catalog usage and the genome hypothesis. *Nucleic Acids Res.* **8**:r49-r62.
107. **Gribaldo, S., and P. Cammarano.** 1998. The root of the universal tree of life inferred from anciently duplicated genes encoding components of the protein-targeting machinery. *J. Mol. Evol.* **47**:508-516.
108. **Guiltinan, M. J., D.-P. Ma, R. F. Barker, M. M. Bustos, R. J. Cyr, R. Yadegari, and D. E. Fosket.** 1987. The isolation, characterization and sequence of two divergent  $\beta$ -tubulin genes from soybean (*Glycine max* L.). *Plant Mol. Biol.* **10**:171-184.
109. **Gwo-Shu Lee, M., S. A. Lewis, C. D. Wilde, and N. J. Cowan.** 1983. Evolutionary history of a multigene family: an expressed human  $\beta$ -tubulin gene and three processed pseudogenes. *Cell.* **33**:477-487.
110. **Hall, S. L., and R. A. Padgett.** 1994. Conserved sequences in a class of rare eukaryotic nuclear introns with non-consensus splice sites. *J. Mol. Biol.* **239**:357-365.
111. **Hall, S. L., and R. A. Padgett.** 1996. Requirement of U12 snRNA for in vivo splicing of a minor class of eukaryotic nuclear pre-mRNA introns. *Science.* **271**:1716-1718.
112. **Han, I.-S., I. Jongewaard, and D. E. Fosket.** 1991. Limited expression of a diverged  $\beta$ -tubulin gene during soybean (*Glycine max* [L.] Merr.) development. *Plant Mol. Biol.* **16**:225-235.
113. **Hankeln, T., H.-G. Keyl, R. Ross, and E. R. Schmidt.** 1993. Evolution of histone gene loci in chironomid midges. *Genome.* **36**:852-862.

114. **Hankeln, T., and E. R. Schmidt.** 1993. Divergent evolution of an "orphan" histone gene cluster in *Chironomus*. *J. Mol. Biol.* **234**:1301-1307.
115. **Hasegawa, M., and T. Hashimoto.** 1993. Ribosomal rRNA tree misleading? *Nature.* **361**:23.
116. **Hashimoto, T., Y. Nakamura, T. Kamaishi, F. Nakamura, J. Adachi, K.-I. Okamoto, and M. Hasegawa.** 1995. Phylogenetic place of mitochondrial-lacking protozoan, *Giardia lamblia*, inferred from amino acid sequences of elongation factor 2. *Mol. Biol. Evol.* **12**:782-793.
117. **He, M., and D. S. Haymer.** 1995. Codon bias in actin multigene families and effects on the reconstruction of phylogenetic relationships. *J. Mol. Evol.* **41**:141-149.
118. **Hensel, R., P. Zwickl, S. Fabry, J. Lang, and P. Palm.** 1989. Sequence comparison of glyceraldehyde-3-phosphate dehydrogenase from the three kingdoms: evolutionary implications. *Can. J. Microbiol.* **35**:81-85.
119. **Hibbett, D. S.** 1992. Ribosomal RNA and fungal systematics. *Trans. Mycol. Soc. Jpn.* **33**:533-556.
120. **Hillis, D. M., C. Moritz, C. A. Porter, and R. J. Baker.** 1991. Evidence for biased gene conversion in concerted evolution of ribosomal DNA. *Science.* **18**:308-310.
121. **Hiraoka, Y., T. Toda, and M. Yanagida.** 1984. The *NDA3* gene of fission yeast encodes  $\beta$ -tubulin: a cold-sensitive *nda3* mutation reversibly blocks spindle formation and chromosome movement in mitosis. *Cell.* **39**:349-358.
122. **Hirt, R. P., B. Healy, C. R. Vossbrinck, E. U. Canning, and T. M. Embley.** 1997. A mitochondrial *Hsp70* orthologue in *Vairimorpha necatrix*: molecular evidence that microsporidia once contained mitochondria. *Curr. Microbiol.* **7**:995-998.
123. **Hirt, R. P., J. M. Logsdon Jr, B. Healy, M. W. Dorey, W. F. Doolittle, and T. M. Embley.** 1999. Microsporidia are related to fungi: evidence from the largest subunit of RNA polymerase II and other proteins. *Proc. Natl. Acad. Sci. USA.* **96**:580-585.
124. **Holmquist, R.** 1983. Transitions and transversions in evolutionary descent: an approach to understanding. *J. Mol. Evol.* **19**:134-144.
125. **Honeycutt, R. L., M. A. Nedbal, R. M. Adkins, and L. L. Janecek.** 1995. Mammalian mitochondrial DNA evolution: a comparison of the cytochrome *b* and cytochrome *c* oxidase genes. *J. Mol. Evol.* **40**:260-272.
126. **Hsieh, W. H., S. N. Smith, and W. C. Snyder.** 1977. Mating groups in *Fusarium moniliforme*. *Phytopathology.* **67**:1041-1043.
127. **Hughes, A. L.** 1999. Concerted evolution of exons and introns in the MHC-linked tenascin-X gene of mammals. *Mol. Biol. Evol.* **16**:1558-1567.



128. **Hussey, P. J., N. Haas, J. Hunsperger, J. Larkin, D. P. Snustad, and C. D. Silflow.** 1990. The  $\beta$ -tubulin gene family in *Zea mays*: two differentially expressed  $\beta$ -tubulin genes. *Plant Mol. Biol.* **15**:957-972.
129. **Hussey, P. J., C. W. Lloyd, and K. Gull.** 1988. Differential and developmental expression of  $\beta$ -tubulin in higher plants. *J. Biol. Chem.* **263**:5474-5479.
130. **Ikemura, T.** 1985. Codon usage and tRNA content in unicellular and multicellular organisms. *Mol. Biol. Evol.* **2**:13-34.
131. **Ikemura, T.** 1982. Correlation between the abundance of yeast transfer RNAs and the occurrence of the respective codons in protein genes. *J. Mol. Biol.* **158**:573-597.
132. **Ikemura, T., and H. Ozeki.** 1982. Codon usage and transfer RNA contents: Organism-specific codon-choice patterns in reference to isoacceptor contents. *Cold Spring Harbor Symp. Quant. Biol.* **47**:1087-1097.
133. **Iwabe, N., K. Kuma, H. Kishino, M. Hasegawa, and T. Miyata.** 1991. Evolution of RNA polymerase and branching patterns of the three major groups of Archaeobacteria. *J. Mol. Evol.* **32**:70-78.
134. **Iwabe, N., K.-E. Kuma, H. Kishino, M. Hasegawa, and T. Miyata.** 1990. Compartmentalized isozyme genes and the origin of introns. *J. Mol. Evol.* **31**:205-210.
135. **Iwabe, N., K.-I. Kuma, M. Hasegawa, S. Osawa, and T. Miyata.** 1989. Evolutionary relationship of archaeobacteria, eubacteria, and eukaryotes inferred from phylogenetic trees of duplicated genes. *Proc. Natl. Acad. Sci. USA.* **86**:9355-9359.
136. **Jackson, I. J.** 1991. A reappraisal of non-consensus mRNA splice sites. *Nucleic Acids Res.* **19**:3795-3798.
137. **Jacquier, A.** 1990. Self-splicing group II and nuclear pre-mRNA introns: how similar are they? *Trends Biochem. Sci.* **15**:351-254.
138. **Janbon, G., E. P. Rustchenko, S. Klug, S. Scherer, and F. Sherman.** 1997. Phylogenetic relationships of fungal cytochromes *c*. *Yeast.* **13**:985-990.
139. **Kamaishi, T., T. Hashimoto, Y. Nakamura, Y. Masuda, F. Nakamura, K. Okamoto, M. Shimizu, and M. Hasegawa.** 1996. Complete nucleotide sequences of the genes encoding translation elongation factors 1 $\alpha$  and 2 from a microsporidian parasite, *Glugea plecoglossi*: Implications for the deepest branching of eukaryotes. *J. Biochem.* **120**:1095-1103.
140. **Kano, R., Y. Nakamura, T. Watari, S. Watanabe, H. Takahashi, H. Tsujimoto, and A. Hasagawa.** 1998. Molecular analysis of chitin synthase I (*CHS1*) gene sequences of *Trichophyton mentagrophytes* complex and *T. rubrum*. *Curr. Microbiol.* **37**:236-239.
141. **Keeling, P. J.** 1998. A kingdom's progress: Archaezoa and the origin of eukaryotes. *BioEssays.* **20**:87-95.

142. **Keeling, P. J., J. A. Deane, C. Hink-Schauer, S. E. Douglas, U.-G. Maier, and G. I. McFadden.** 1999. The secondary endosymbiont of the Cryptomonad *Guillardia theta* contains alpha-, beta- and gamma-tubulin genes. *Mol. Biol. Evol.* **16**:1308-1313.
143. **Keeling, P. J., J. A. Deane, and G. I. McFadden.** 1998. The phylogenetic position of alpha- and beta-tubulins from the *Chlorarachnion* host and *Cercomonas* (Cercozoa). *J. Eukaryot. Microbiol.* **45**:561-570.
144. **Keeling, P. J., and W. F. Doolittle.** 1996. Alpha-tubulin from early-diverging eukaryotic lineages and the evolution of the tubulin gene family. *Mol. Biol. Evol.* **13**:1297-1305.
145. **Keeling, P. J., M. A. Luker, and J. D. Palmer.** 2000. Evidence from beta-tubulin phylogeny that Microsporidia evolved from within the fungi. *Mol. Biol. Evol.* **17**:21-31.
146. **Kemmerer, E. C., M. Lei, and R. Wu.** 1991. Structure and molecular evolutionary analysis of a plant cytochrome c gene: surprising implications for *Arabidopsis thaliana*. *J. Mol. Evol.* **32**:227-234.
147. **Kita, K., T. Fukura, K.-I. Nakase, K. Okamoto, H. Yanase, M. Kataoka, and S. Shimizu.** 1999. Cloning, overexpression, and mutagenesis of the *Sporobolomyces salmonicolor* AKU4429 gene encoding a new aldehyde reductase, which catalyzes the stereoselective reduction of ethyl 4-chloro-3-oxobutanoate to ethyl (S)-4-chloro-3-hydroxybutanoate. *Appl. Environ. Microbiol.* **65**:5207-5211.
148. **Kmieciak, D., M. Couppez, D. Belaiche, and P. Sautiere.** 1983. Primary structure of histone H2A from nucleated erythrocyte of the marine worm *Sipunculus nudus*. *Eur. J. Biochem.* **135**:113-121.
149. **Kobayashi, M., H. Wada, and N. Satoh.** 1996. Early evolution of the metazoa and phylogenetic status of diploblasts as inferred from amino acid sequence of elongation factor-1 $\alpha$ . *Mol. Phylogenet. Evol.* **5**:414-422.
150. **Koenraadt, H., and A. L. Jones.** 1993. Resistance to benomyl conferred by mutations in codon 198 or 200 of the beta-tubulin gene of *Neurospora crassa* and sensitivity to diethofencarb conferred by codon 198. *Phytopathology.* **83**:850-854.
151. **Kogan, G. L., V. N. Epstein, A. A. Aravin, and V. A. Gvosdev.** 2000. Molecular evolution of two paralogous tandemly repeated heterochromatic gene clusters linked to the X and Y chromosomes of *Drosophila melanogaster*. *Mol. Biol. Evol.* **17**:697-702.
152. **Kojima, S.** 1998. Paraphyletic status of Polychaeta suggested by phylogenetic analysis based on the amino acid sequences of elongation factor-1 $\alpha$ . *Mol. Phylogenet. Evol.* **9**:255-261.
153. **Kopczak, S. D., N. A. Haas, P. J. Hussey, C. D. Silflow, and P. D. Snustad.** 1992. The small genome of *Arabidopsis* contains at least six expressed  $\alpha$ -tubulin genes. *Plant Cell.*

- 4:539-547.
154. **Koufopanou, V., A. Burt, and W. J. Taylor.** 1997. Concordance of gene genealogies reveals reproductive isolation in the pathogenic fungus *Coccidioides immitis*. Proc. Natl. Acad. Sci. USA. **94**:5478-5482.
  155. **Kretzer, A. M., and T. D. Bruns.** 1999. Use of *atp6* in fungal phylogenetics: an example from the Boletales. Mol. Phylogenet. Evol. **13**:483-492.
  156. **Kruse, M., V. Gamulin, H. Cetkovic, Z. Pancer, I. M. Muller, and W. E. G. Muller.** 1996. Molecular evolution of the metazoan protein kinase C multigene family. J. Mol. Evol. **43**:374-383.
  157. **Kuma, K., N. Nikoh, N. Iwabe, and T. Miyata.** 1995. Phylogenetic position of *Dictyostelium* inferred from multiple protein data sets. J. Mol. Evol. **41**:238-246.
  158. **Kusakabe, T., I. Araki, N. Satoh, and W. R. Jeffery.** 1997. Evolution of chordate actin genes: evidence from genomic organization and amino acid sequences. J. Mol. Evol. **44**:289-298.
  159. **Lafay, B., and P. M. Sharp.** 1999. Synonymous codon usage variation among *Giardia lamblia* genes and isolates. Mol. Biol. Evol. **16**:1484-1495.
  160. **Lambowitz, A. M., and M. Belfort.** 1993. Introns as mobile genetic elements. Annu. Rev. Biochem. **62**:587-622.
  161. **Lazcano, A., J. Fastag, P. Gariglio, C. Ramirez, and J. Oro.** 1988. On the early evolution of RNA polymerase. J. Mol. Evol. **27**:365-376.
  162. **Lee, S. H., J. C. Kim, M. S. Lee, W. D. Heo, H. Y. Seo, H. W. Yoon, J. C. Hong, S. Y. Lee, J. D. Bahk, I. Hwang, and M. J. Cho.** 1995. Identification of a novel divergent calmodulin isoform from soybean which has differential ability to activate calmodulin-dependent enzymes. J. Biol. Chem. **270**:21806-21812.
  163. **Lee, Y. H., X.-Y. Huang, D. Hirsh, G. E. Fox, and R. M. Hecht.** 1992. Conservation of gene organization and *trans*-splicing in the glyceraldehyde-3-phosphate dehydrogenase-encoding genes of *Caenorhabditis briggsae*. Gene. **121**:227-235.
  164. **Leslie, J. F.** 1995. *Gibberella fujikuroi*: Available populations and variable traits. Can. J. Bot. **73**:S282-S291.
  165. **Leslie, J. F.** 1991. Mating populations in *Gibberella fujikuroi* (*Fusarium* section *Liseola*). Phytopathology. **81**:1058-1060.
  166. **Lewis, L. A., B. D. Mishler, and R. Vilgalys.** 1997. Phylogenetic relationships of the liverworts (Hepaticae), a basal embryophyte lineage, inferred from nucleotide sequence data of the chloroplast gene *rbcL*. Mol. Phylogenet. Evol. **7**:377-393.
  167. **Li, W.-H., and D. Graur.** 1991. Fundamentals of molecular evolution. Sinauer Associates,



Inc., Sunderland, Massachusetts.

168. **Liaud, M.-F., H. Brinkmann, and R. Cerff.** 1992. The  $\beta$ -tubulin gene family of pea: Primary structures, genomic organization and intron-dependent evolution of genes. *Plant Mol. Biol.* **18**:639-651.
169. **Liaud, M.-F., C. Lichtle, K. Apt, W. Martin, and R. Cerff.** 2000. Compartment-specific isoforms of TPI and GAPDH are imported into diatom mitochondria as a fusion protein: evidence in favor of a mitochondrial origin of eukaryotic glycolytic pathway. *Mol. Biol. Evol.* **17**:213-223.
170. **Liu, Y. J., S. Whelen, and B. D. Hall.** 1999. Phylogenetic relationships among Ascomycetes: Evidence from an RNA polymerase II subunit. *Mol. Biol. Evol.* **16**:1799-1808.
171. **Lloyd, A. T., and P. M. Sharp.** 1992. Evolution of codon usage patterns: the extent and nature of divergence between *Candida albicans* and *Saccharomyces cerevisiae*. *Nucleic Acids Res.* **20**:5289-5295.
172. **Logsdon Jr, J. M., A. Stoltzfus, and W. F. Doolittle.** 1998. Molecular evolution: Recent cases of spliceosomal intron gain? *Curr. Biol.* **8**:R560-R563.
173. **Long, M., and M. Deutsch.** 1999. Association of intron phases with conservation at splice site sequences and evolution of spliceosomal introns. *Mol. Biol. Evol.* **16**:1528-1534.
174. **Lutkenhaus, J.** 1993. FtsZ ring in bacterial cytokinesis. *Mol. Microbiol.* **9**:403-409.
175. **Lyddiatt, A., D. Peacock, and D. Boulter.** 1978. Evolutionary change in invertebrate cytochrome c. *J. Mol. Evol.* **11**:35-45.
176. **Lyons-Weiler, J., and G. A. Hoelzer.** 1999. Null model selection, compositional bias, character state bias, and the limits of phylogenetic information. *Mol. Biol. Evol.* **16**:1400-1405.
177. **Madhani, H. D., and C. Guthrie.** 1994. Dynamic RNA-RNA interactions in the spliceosome. *Annu. Rev. Genetics.* **28**:1-26.
178. **Margolin, W., R. Wang, and M. Kumar.** 1996. Isolation of an *ftsZ* homologue from the archaeobacterium *Halobacterium salinarium*: implications for the evolution of *ftsZ* and tubulin. *J. Bacteriol.* **178**:1320-1327.
179. **Marinets, A., M. Muller, P. J. Johnson, J. Kulda, O. Scheiner, G. Wierdermann, and M. Duchene.** 1996. The sequence and organization of the core histone H3 and H4 genes in the early branching amitochondriate protist *Trichomonas vaginalis*. *J. Mol. Evol.* **43**:563-571.
180. **Markos, A., A. Morris, C. Rozario, and M. Muller.** 1996. Primary structure of a cytosolic malate dehydrogenase of the amitochondriate eukaryote, *Trichomonas vaginalis*. *FEMS*

Microbiol. Lett. **135**:259-264.

181. **Marks, M. D., J. West, and D. P. Weeks.** 1987. The relatively large beta-tubulin gene family of *Arabidopsis* contains a member with an unusual transcribed 5' noncoding sequence. *Plant Mol. Biol.* **10**:91-104.
182. **Martin, A. P.** 1999. Substitution rates of organelle and nuclear genes in sharks: implicating metabolic rate (again). *Mol. Biol. Evol.* **16**:996-1002.
183. **Martin, P. G., D. Boulter, and D. Penny.** 1985. Angiosperm phylogeny studied using sequences of five macromolecules. *Taxon.* **34**:393-400.
184. **Martin, P. G., J. M. Dowd, and S. J. L. Stone.** 1983. The study of plant phylogeny using amino acid sequences of ribulose-1,5-bisphosphate carboxylase. II The analysis of small subunit data to form phylogenetic trees. *Aust. J. Bot.* **31**:411-419.
185. **Martinez, P., W. Martin, and R. Cerff.** 1989. Structure, evolution and anaerobic regulation of a nuclear gene encoding cytosolic glyceraldehyde-3-phosphate dehydrogenase from maize. *J. Mol. Biol.* **208**:551-565.
186. **Maxson, R., T. Mohun, G. Gormezano, and L. Kedes.** 1987. Evolution of late H2A, H2B and H4 histone genes of the sea urchin, *Strongylocentrotus purpuratus*. *Nucleic Acids Res.* **15**.
187. **May, G. S., M. L.-S. Tsang, H. Smith, S. Fidel, and N. R. Morris.** 1987. *Aspergillus nidulans*  $\beta$ -tubulin genes are unusually divergent. *Gene.* **55**:231-243.
188. **Maynard Smith, J., and N. H. Smith.** 1998. Detecting recombination from gene trees. *Mol. Biol. Evol.* **15**:590-599.
189. **McDowell, J. M., S. Huang, E. C. McKinney, Y.-Q. An, and R. B. Meagher.** 1996. Structure and evolution of the actin gene family in *Arabidopsis thaliana*. *Genetics.* **142**:587-602.
190. **Meagher, R. D.** 1991. Divergence and differential expression of actin gene families in higher plants. *Int. Rev. Cytol.* **125**:139-163.
191. **Mehmann, B., I. Brunner, and G. H. Braus.** 1994. Nucleotide sequence variation of chitin synthase genes among ectomycorrhizal fungi and its potential use in taxonomy. *Appl. Environ. Microbiol.* **60**:3105-3111.
192. **Mellado, E., A. Aufauvre-Brown, N. A. R. Gow, and D. W. Holden.** 1996. The *Aspergillus fumigatus* *chsC* and *chsG* genes encode class III chitin synthases with different functions. *Mol. Microbiol.* **20**:667-679.
193. **Mellado, E., A. Aufauvre-Brown, C. A. Specht, P. W. Robbins, and D. W. Holden.** 1995. A multigene family related to chitin synthase genes of yeast in the opportunistic pathogen *Aspergillus fumigatus*. *Mol. Gen. Genet.* **246**:353-359.

194. **Michel, F., and J.-L. Ferat.** 1995. Structure and activities of group II introns. *Annu. Rev. Biochem.* **64**:435-461.
195. **Michels, P. A. M., M. Marchand, L. Kohl, S. Allert, R. K. Wierenga, and F. R. Opperdoes.** 1991. The cytosolic and glycosomal isoenzymes of glyceraldehyde-3-phosphate dehydrogenase in *Trypanosoma brucei* have a distant evolutionary relationship. *Eur. J. Biochem.* **198**:421-428.
196. **Mikuni, J., and N. Morohoshi.** 1997. Cloning and sequencing of a second laccase gene from the white-rot fungus *Coriolus versicolor*. *FEMS Microbiol. Lett.* **155**:79-84.
197. **Miller, D. J., P. L. Harrison, T. J. Mahony, J. P. McMillan, A. Miles, D. M. Odorica, and M. R. ten Lohuis.** 1993. Nucleotide sequence of the histone gene cluster in the coral *Acropora formosa* (Cnidaria; Scleractinia): Features of histone gene structure and organization are common to diploblastic and triploblastic metazoans. *J. Mol. Evol.* **37**:245-253.
198. **Mio, T., T. Yabe, M. Sudoh, Y. Satoh, T. Nakajima, M. Arisawa, and H. Yamada-Okabe.** 1996. Role of three chitin synthase genes in the growth of *Candida albicans*. *J. Bacteriol.* **178**:2416-2419.
199. **Mort-Bontemps, M., L. Gay, and M. Fevre.** 1997. *CHS2*, a chitin synthase gene from the oomycete *Saprolegnia monoica*. *Microbiology.* **143**:2009-2020.
200. **Mount, S. M.** 1996. AT-AC introns: an ATtACk on dogma. *Science.* **271**:1690-1692.
201. **Nakamura, Y., T. Hashimoto, T. Kamaishi, J. Adachi, F. Nakamura, K. Okamoto, and M. Hasegawa.** 1996. Phylogenetic position of kinetoplastid protozoa inferred from the protein phylogenies of elongation factors 1 $\alpha$  and 2. *J. Biochem.* **119**:70-79.
202. **Neff, N. F., J. H. Thomas, P. Grisafi, and D. Botstein.** 1983. Isolation of the  $\beta$ -tubulin gene from yeast and demonstration of its essential function in vivo. *Cell.* **33**:211-219.
203. **Nelson, D. R.** 1999. Cytochrome P450 and the individuality of species. *Arch. Biochem. Biophys.* **369**:1-10.
204. **Nelson, P. E., T. A. Toussoun, and W. F. O. Marasas.** 1983. *Fusarium* species: an illustrated manual of identification. Pennsylvania State University Press, University Park.
205. **Newman, A. J.** 1997. The role of U5 snRNP in pre-mRNA splicing. *EMBO J.* **19**:5797-5800.
206. **Nielsen, P. S., A. Kleinshofs, and O.-A. Olsen.** 1997. Barley elongation factor 1 $\alpha$ : genomic organization, DNA sequence, and phylogenetic implications. *Genome.* **40**:559-565.
207. **Nikoh, N., N. Hayase, N. Iwabe, K.-I. Kuma, and T. Miyata.** 1994. Phylogenetic relationship of the kingdoms Animalia, Plantae, and Fungi inferred from 23 different protein sequences. *Mol. Biol. Evol.* **11**:762-768.

208. **Nikoh, N., N. K. Iwabe, K.-E., M. Ohno, T. Sugiyama, Y. Watanabe, K. Yasui, Z. Shicui, K. Hori, Y. Shimura, and T. Miyata.** 1997. An estimate of divergence of time of Parazoa and Eumetazoa and that of Cephalochordata and Vertebrata by aldolase and triose phosphate isomerase clocks. *J. Mol. Evol.* **45**:97-106.
209. **Nirenberg, H. I., and K. O'Donnell.** 1998. New *Fusarium* species and combinations within the *Gibberella fujikuroi* species complex. *Mycologia.* **90**:434-458.
210. **Normark, B. B.** 2000. Molecular systematics and evolution of the aphid family Lachnidae. *Mol. Phylogenet. Evol.* **14**:131-140.
211. **Nyrberg, A. M., and M. B. Cronhjort.** 1992. Intron evolution: a statistical comparison of two models. *J. Theor. Biol.* **157**:175-190.
212. **O'Donnell, K., and E. Cigelnik.** 1997. Two divergent intragenomic rDNA ITS2 types within a monophyletic lineage of the fungus *Fusarium* are nonorthologous. *Mol. Phylogenet. Evol.* **7**:103-116.
213. **O'Donnell, K., E. Cigelnik, and H. I. Nirenberg.** 1998. Molecular systematics and phylogeography of the *Gibberella fujikuroi* species complex. *Mycologia.* **90**:465-493.
214. **O'Donnell, K., H. C. Kistler, E. Cigelnik, and R. C. Ploetz.** 1998. Multiple evolutionary origins of the fungus causing Panama disease of banana: concordant evidence from nuclear, mitochondrial gene sequences. *Proc. Natl. Acad. Sci. USA.* **95**:2044-2049.
215. **O'Donnell, K., H. C. Kistler, B. K. Tacke, and H. H. Casper.** 2000. Gene genealogies reveal global phylogenetic structure and reproductive isolation among lineages of *Fusarium graminearum*, the fungus causing wheat scab. *Proc. Natl. Acad. Sci. USA.* **97**:7905-7910.
216. **O'Donnell, K., H. I. Nirenberg, T. Aoki, and E. Cigelnik.** 2000. A multigene phylogeny of the *Gibberella fujikuroi* species complex: Detection of additional phylogenetically distinct species. *Mycoscience.* **41**:61-78.
217. **Ohno, S.** 1970. Why gene duplication? In S. Ohno (ed.), *Evolution by gene duplication.* Springer-Verlag, New York.
218. **Ohya, Y., and D. Botstein.** 1994. Structure-based systematic isolation of conditional-lethal mutations in the single yeast calmodulin gene. *Genetics.* **138**:1041-1054.
219. **Old, R. W., and H. R. Woodland.** 1984. Histone genes: not so simple after all. *Cell.* **38**:624-626.
220. **Orbach, M. J., E. B. Porro, and C. Yanofsky.** 1986. Cloning and characterization of the gene for  $\beta$ -tubulin from a benomyl-resistant mutant of *Neurospora crassa* and its use as a dominant selectable marker. *Mol. Cell. Biol.* **6**:2452-2461.
221. **Palumbi, S. R., and F. Cipriano.** 1998. Species identification using genetic tools: the value of nuclear and mitochondrial gene sequences in whale conservation. *J. Hered.* **89**:459-464.



222. **Panaccione, D. G., and R. M. Hanau.** 1990. Characterization of two divergent  $\beta$ -tubulin genes from *Colletotrichum graminicola*. *Gene*. **86**:163-170.
223. **Paquin, B., M.-J. Laforest, and F. Lang.** 1994. Interspecific transfer of mitochondrial genes in fungi and creation of a homologous hybrid gene. *Proc. Natl. Acad. Sci. USA*. **91**:11807-11810.
224. **Parsch, J., S. Tanda, and W. Stephan.** 1997. Site-directed mutations reveal long-range compensatory interactions in the *Adh* gene of *Drosophila melanogaster*. *Proc. Natl. Acad. Sci. USA*. **94**:928-933.
225. **Percudani, R., and S. Ottenello.** 1999. Selection at the wobble position of codons read by the same tRNA in *Saccharomyces cerevisiae*. *Mol. Biol. Evol.* **16**:1752-1762.
226. **Philippe, H., and A. Germot.** 2000. Phylogeny of eukaryotes based on ribosomal RNA: long-branch attraction and models of sequence evolution. *Mol. Biol. Evol.* **17**:830-834.
227. **Puhler, G., H. Leffers, F. Gropp, P. Palm, H.-P. Klenk, F. Lottspeich, R. A. Garrett, and W. Zillig.** 1989. Archaeobacterial DNA-dependent RNA polymerases testify to the evolution of the eukaryotic nuclear genome. *Proc. Natl. Acad. Sci. USA*. **86**:4569-4573.
228. **Quigley, F., H. Brinkmann, W. F. Martin, and R. Cerff.** 1989. Strong functional GC pressure in a light-regulated maize gene encoding subunit GAPA of chloroplast glyceraldehyde-3-phosphate dehydrogenase: implications for the evolution of GAPA pseudogenes. *J. Mol. Evol.* **29**:412-421.
229. **Quigley, F., W. F. Martin, and R. Cerff.** 1988. Intron conservation across the prokaryote-eukaryote boundary: Structure of the nuclear gene chloroplast glyceraldehyde-3-phosphate dehydrogenase from maize. *Proc. Natl. Acad. Sci. USA*. **85**:2672-2676.
230. **Radford, A.** 1993. A fungal phylogeny based upon orotidine 5'-monophosphate decarboxylase. *J. Mol. Evol.* **36**:389-395.
231. **Raha, D., K. Sen, and B. B. Biswas.** 1987. cDNA cloning of  $\beta$ -tubulin gene and organization of tubulin genes in *Vigna radiata* (mung bean) genome. *Plant Mol. Biol.* **9**:656-671.
232. **Recipon, H., R. Perasso, A. Addoutte, and F. Quetier.** 1992. ATP synthase subunit c/III/9 gene sequence as a tool for interkingdom and metaphytes molecular phylogeny. *J. Mol. Evol.* **34**:292-303.
233. **Reed, R. D., and F. A. H. Sperling.** 1999. Interaction of process partitions in phylogenetic analysis: an example from the swallowtail butterfly genus *Papilio*. *Mol. Biol. Evol.* **16**:286-297.
234. **Regier, J. C., B. M. Wiegman, R. F. Leclerc, and T. P. Friedlander.** 1994. Loss of phylogenetic information in chorion gene families of *Bombyx mori* by gene conversion.

- Mol. Biol. Evol. **11**:72-87.
235. **Reiger, J. C., Q. Q. Fang, C. Mitter, R. S. Peigler, T. P. Friedlander, and M. A. Solis.** 1998. Evolution and phylogenetic utility of the *period* gene in Lepidoptera. Mol. Biol. Evol. **15**:1172-1182.
236. **Roger, A. J., P. J. Keeling, and W. F. Doolittle.** 1994. Introns, the broken transposons. Soc. Gen. Physiol. Ser. **49**:27-37.
237. **Roger, A. J., O. Sandblom, W. F. Doolittle, and H. Philippe.** 1999. An evolution of elongation factor 1 $\alpha$  as a phylogenetic marker for eukaryotes. Mol. Biol. Evol. **16**:218-233.
238. **Roy, S. W., M. Nosaka, S. J. de Souza, and W. Gilbert.** 1999. Centripetal modules and ancient introns. Gene. **238**:85-91.
239. **Saloheimo, M., M.-L. Niku-Paavola, and J. K. C. Knowles.** 1991. Isolation and structural analysis of the laccase gene from the lignin-degrading fungus *Phlebia radiata*. J. Gen. Microbiol. **137**:1537-1544.
240. **Sanderson, M. J., and J. J. Doyle.** 1992. Reconstruction of organismal and gene phylogenies from data on multigene families: concerted evolution, homoplasy, and confidence. Syst. Biol. **41**:4-17.
241. **Sanson, G. F. O. B., M.R.S.** 2000. Typing of *Candida glabrata* in clinical isolates by comparative sequence analysis of the cytochrome *c* oxidase subunit 2 gene distinguishes two clusters of strains associated with geographical sequence polymorphisms. J. Clin. Microbiol. **38**:227-235.
242. **Sburlati, A., and E. Cabib.** 1986. Chitin synthase 2, a presumptive participant in septum formation in *Saccharomyces cerevisiae*. J. Biol. Chem. **261**:15147-15152.
243. **Schardl, C. L., A. Leuchtman, H.-F. Tsai, M. A. Collett, D. M. Watt, and D. B. Scott.** 1994. Origin of a fungal symbiont of perennial ryegrass by interspecific hybridization of a mutualist with ryegrass choke pathogen, *Epichloë typhina*. Genetics. **136**:1307-1317.
244. **Schimenti, J. C.** 1999. Mice and the role of unequal recombination in gene-family evolution. Am. J. Hum. Genet. **64**:40-45.
245. **Schutze, J., A. Krasko, M. R. Custodio, S. M. Efremova, I. M. Muller, and W. E. G. Muller.** 1999. Evolutionary relationships of metazoa within the eukaryotes based on molecular data from Porifera. Proc. R. Soc. Lon. B. **266**:63-73.
246. **Schwob, E., and R. P. Martin.** 1992. New yeast actin-like gene required late in the cell cycle. Nature. **355**:179-182.
247. **Seiffert, K. A., B. D. Wingfield, and M. J. Wingfield.** 1995. A critique of DNA sequence analysis in the taxonomy of filamentous Ascomycetes and ascomycetous anamorphs. Can. J. Bot. **73**:S760-S767.

248. **Senapathy, P.** 1986. Origin of eukaryotic introns: a hypothesis, based on codon distribution statistics in genes, and its implications. *Proc. Natl. Acad. Sci. USA.* **83**:2133-2137.
249. **Sharp, P. A., and C. B. Burge.** 1997. Classification of introns: U2-type or U12-type. *Cell.* **91**:875-879.
250. **Sharp, P. M., and A. T. Lloyd.** 1993. Regional base composition variation along yeast chromosome III: evolution of chromosome primary structure. *Nucleic Acids Res.* **21**:179-183.
251. **Shearer Jr, G.** 1995. Cloning and analysis of cDNA encoding an elongation factor 1 $\alpha$  from the dimorphic fungus *Histoplasma capsulatum*. *Gene.* **161**:119-123.
252. **Sherwood, J. E., and S. C. Sommerville.** 1989. Molecular characterization of a  $\beta$ -tubulin gene from *Erysiphe graminis*. *Phytopathology.* **79**:1205.
253. **Shpaer, E. G.** 1985. The secondary structure of mRNAs from *Escherichia coli*: its possible role in increasing the accuracy of translation. *Nucleic Acids Res.* **13**:275-288.
254. **Sidow, A., and W. K. Thomas.** 1994. A molecular evolutionary framework for eukaryotic model organisms. *Curr. Biol.* **4**:596-603.
255. **Simpson, G. G., and W. Filipowicz.** 1996. Splicing of precursors to mRNA in higher plants: mechanism, regulation and sub-nuclear organization of the spliceosomal machinery. *Plant Mol. Biol.* **32**:1-41.
256. **Singh, G., P. S. Dyer, and A. M. Ashby.** 1999. Intra-specific and inter-specific conservation of mating-type genes from the discomycete plant-pathogenic fungi *Pyrenopeziza brassicae* and *Tapesia yallundae*. *Curr. Genet.* **36**:290-300.
257. **Smith, H. A., H. S. Allaudeen, H. Whitman, Y. Koltin, and J. A. Gorman.** 1988. Isolation and characterization of a  $\beta$ -tubulin gene from *Candida albicans*. *Gene.* **63**:53-63.
258. **Smith, T. L.** 1989. Disparate evolution of yeast and filamentous fungi indicated by phylogenetic analysis of glyceraldehyde-3-phosphate dehydrogenase genes. *Proc. Natl. Acad. Sci. USA.* **86**:7063-7066.
259. **Snustad, D. P., N. A. Haas, D. S. Koczak, and C. D. Silflow.** 1992. The small genome of *Arabidopsis* contains at least nine expressed  $\beta$ -tubulin genes. *Plant Cell.* **4**:549-556.
260. **Sogin, M. L.** 1997. History assignment: when was the mitochondrion founded? *Curr. Opin. Genet. Dev.* **7**:792-799.
261. **Stedman, T. T., D. R. Butler, and G. A. Buck.** 1998. The HSP70 gene family in *Pneumocystis carinii*: molecular and phylogenetic characterization of cytoplasmic members. *J. Eukaryot. Microbiol.* **45**:589-599.
262. **Steenkamp, E., H. Britz, T. Coutinho, B. Wingfield, W. Marasas, and M. Wingfield.**

2000. Molecular characterization of *Fusarium subglutinans* associated with mango malformation. *Mol. Plant Pathol.* **1**:187-193.
263. Steenkamp, E. T., B. D. Wingfield, T. A. Coutinho, M. J. Wingfield, and W. F. O. Marasas. 1999. Differentiation of *Fusarium subglutinans* f. sp. *pini* by histone gene sequence data. *Appl. Environ. Microbiol.* **65**:3401-3406.
264. Steenkamp, E. T., B. D. Wingfield, T. A. Coutinho, K. A. Zeller, M. J. Wingfield, W. F. O. Marasas, and J. F. Leslie. 2000. PCR-based identification of *MAT-1* and *MAT-2* in the *Gibberella fujikuroi* species complex. *Appl. Environ. Microbiol.* **66**:4378-4382.
265. Stiller, J. W., and B. D. Hall. 1999. Long-branch attraction and the rDNA model of early eukaryotic evolution. *Mol. Biol. Evol.* **16**:1270-1279.
266. Sullivan, K. F. 1988. Structure and utilization of tubulin genes. *Annu. Rev. Cell Biol.* **4**:687-716.
267. Swofford, D. L. 1998. PAUP\*. Phylogenetic Analysis Using Parsimony (\*and Other Methods). Version 4.0\*. Sinauer Associates, Sunderland, Massachusetts.
268. Swofford, D. L., and G. J. Olsen. 1990. Phylogeny reconstruction, p. 411-501. *In* D. M. Hillis and G. Moritz (ed.), *Molecular Systematics*. Sinauer Associates, Inc., Sunderland, Massachusetts, USA.
269. Tarn, W.-Y., and J. A. Steitz. 1997. Pre-mRNA splicing: the discovery of a new spliceosome doubles the challenge. *Trends Biochem. Sci.* **22**:132-137.
270. Taylor, J. W., D. M. Geiser, A. Burt, and V. Koufopanou. 1999. The evolutionary biology and population genetics underlying fungal strain typing. *Clin. Microbiol. Rev.* **12**:126-146.
271. Taylor, J. W., D. J. Jacobson, and M. C. Fisher. 1999. The evolution of asexual fungi: Reproduction, speciation and classification. *Annu. Rev. Phytopathol.* **37**:197-246.
272. Thatcher, T. H., and M. A. Gorovsky. 1994. Phylogenetic analysis of the core histone H2A, H2B, H3 and H4. *Nucleic Acids Res.* **22**:174-179.
273. Thatcher, T. H., J. MacGaffey, J. Bowen, S. Horowitz, D. L. Shapiro, and M. A. Gorovsky. 1994. Independent evolutionary origin of histone H3.3-like variants of animals and *Tetrahymena*. *Nucleic Acids Res.* **22**:180-186.
274. Thomas, G. H., E. C. Newbern, C. C. Korte, M. A. Bales, S. V. Muse, A. G. Clark, and D. P. Kiehart. 1997. Intragenic duplication and divergence in the spectrin superfamily of proteins. *Mol. Biol. Evol.* **14**:1285-1295.
275. Thomas, W. K., and A. C. Wilson. 1991. Mode and tempo of molecular evolution in the nematode *Caenorhabditis*: cytochrome oxidase II and calmodulin sequences. *Genetics.* **128**:269-279.



276. **Tourasse, N. J., and M. Gouy.** 1999. Accounting for evolutionary rate variation among sequence sites consistently changes universal phylogenies deduced from rRNA and protein-coding genes. *Mol. Phylogenet. Evol.* **13**:159-168.
277. **Trotman, C. N. A.** 1998. Introns-early: slipping lately? *Trends Genet.* **14**:132-134.
278. **Tsai, H.-F., J.-S. Liu, C. Staben, M. J. Christensen, G. C. M. Latch, M. R. Siegel, and C. L. Schardl.** 1994. Evolutionary diversification of fungal endophytes of tall fescue grass by hybridization with *Epichloë* species. *Proc. Natl. Acad. Sci. USA.* **91**:2542-2546.
279. **Turgeon, B. G.** 1998. Application of mating type gene technology to problems in fungal biology. *Annu. Rev. Phytopathol.* **36**:115-137.
280. **van Daal, A., E. M. White, S. C. R. Elgin, and M. A. Gorovsky.** 1990. Conservation of intron position indicates separation of major and variant H2As is an early event in the evolution of eukaryotes. *J. Mol. Evol.* **30**:449-455.
281. **van den Hoff, M., A. Jonker, J. J. Beintema, and W. H. Lamers.** 1995. Evolutionary relationships of the carbamoylphosphate synthase genes. *J. Mol. Evol.* **41**:813-832.
282. **Verdoes, J. C., J. Wery, T. Boekhout, and A. J. J. Van Ooyen.** 1997. Molecular characterization of the glyceraldehyde-3-phosphate dehydrogenase gene of *Phaffia rhodozyma*. *Yeast.* **13**:1231-1242.
283. **Viaud, M., Y. Couteaudier, and G. Riba.** 1998. Molecular analysis of hypervirulent somatic hybrids of the entomopathogenic fungi *Beauveria bassiana* and *Beauveria sulfurescens*. *Appl. Environ. Microbiol.* **64**:88-93.
284. **Villemur, R., N. Haas, C. M. Joyce, D. P. Snustad, and C. D. Silflow.** 1993. Characterization of four new  $\beta$ -tubulin genes and their expression during male flower development in maize (*Zea mays* L.). *Plant Mol. Biol.* **24**:295-315.
285. **Von Dorum, M., and M. Ruvolo.** 1999. Phylogenetic relationships of the new world monkeys (primates, Platyrrhini) based on nuclear G6PD DNA sequences. *Mol. Phylogenet. Evol.* **11**:459-476.
286. **Vossbrinck, C. R., J. V. Maddox, S. Friedman, B. A. Debrunner-Vossbrinck, and C. R. Woese.** 1987. Ribosomal RNA sequence suggests microsporidia are extremely ancient eukaryotes. *Nature.* **326**:411-414.
287. **Vossbrinck, C. R., and C. R. Woese.** 1986. Eukaryotic ribosomes that lack a 5.8S RNA. *Nature.* **320**:287-288.
288. **Wang, L., K. Yokoyama, M. Miyaji, and K. Nishimura.** 1998. The identification and phylogenetic relationship of pathogenic species of *Aspergillus* based on the mitochondrial cytochrome b gene. *Med. Mycol.* **36**:153-164.
289. **Watson, J. D., N. M. Hopkins, J. W. Roberts, J. A. Steitz, and A. M. Weiner.** 1987.

- Molecular biology of the gene, fourth ed. Benjamin/Cummings, Menlo Park, California.
290. **Weerakoon, N. D., J. K. Roberts, L. P. Lehnen, J. M. Wilkinson, J. S. Marshall, and A. R. Hardham.** 1998. Isolation and characterization of the single  $\beta$ -tubulin gene in *Phytophthora cinnamomi*. *Mycologia*. **90**:85-95.
  291. **Weiss, L. M., T. D. Edlind, C. R. Vossbrinck, and T. Hashimoto.** 1999. Microsporidian molecular phylogeny: the fungal connection. *J. Eukaryot. Microbiol.* **46**:17S-18S.
  292. **Wells, D., W. Bains, and L. Kedes.** 1986. Codon usage in histone gene families of higher eukaryotes reflect functional rather than phylogenetic relationships. *J. Mol. Evol.* **23**:224-241.
  293. **Wendel, J. F., A. Schnabel, and T. Seelanan.** 1995. Bidirectional interlocus concerted evolution following allopolyploid speciation in cotton (*Gossypium*). *Proc. Natl. Acad. Sci. USA.* **92**:280-284.
  294. **Werman, S. D., M. S. Springer, and R. J. Britten.** 1990. Nucleic acids I: DNA-DNA hybridization, p. 204-249. *In* D. M. Hillis and C. Moritz (ed.), *Molecular Systematics*. Sinauer Associates, Inc., Sunderland, Massachusetts.
  295. **Wery, J., M. J. M. Dalderum, J. Ter Linde, T. Boekhouds, and A. J. J. Van Ooyen.** 1996. Structural and phylogenetic analysis of the actin gene from the yeast *Phaffia rhodozyma*. *Yeast*. **12**:641-651.
  296. **Wesseling, J. G., M. A. Smits, and J. G. G. Schoenmakers.** 1988. Extremely diverged actin proteins in *Plasmodium falciparum*. *Mol. Biochem. Parasitol.* **30**:143-154.
  297. **Whitehead, M. P., M. T. Shieh, T. E. Cleveland, J. W. Cary, and R. A. Dean.** 1995. Isolation and characterization of polygalacturonase genes (*pecA* and *pecB*) from *Aspergillus flavus*. *Appl. Environ. Microbiol.* **61**:3316-3322.
  298. **Wirth, T., R. Le Guellec, and M. Veuille.** 1999. Directional substitution and evolution of nucleotide content in the cytochrome oxidase II gene in earwigs (Dermapteran insects). *Mol. Biol. Evol.* **16**:1645-1653.
  299. **Woese, C. R., J. Gibson, and G. E. Fox.** 1980. Do genealogical patterns in purple photosynthetic bacteria reflect interspecific gene transfer? *Nature.* **283**:212-214.
  300. **Wojtas, K. M., L. Von Kalm, J. R. Weaver, and D. T. Sullivan.** 1992. The evolution of duplicate glyceraldehyde-3-phosphate dehydrogenase genes in *Drosophila*. *Genetics.* **132**:789-797.
  301. **Xoconostle-Cazares, B., C. A. Specht, P. W. Robbins, Y. Liu, C. Leon, and J. Ruiz-Herrera.** 1997. *Umchs5*, a gene encoding for a class IV chitin synthase in *Ustilago maydis*. *Fungal Genet. Biol.* **22**:199-208.
  302. **Yan, K., and M. B. Dickman.** 1996. Isolation of a  $\beta$ -tubulin gene from *Fusarium*

- moniliforme* that confers cold-sensitive benomyl resistance. *Appl. Environ. Microbiol.* **62**:3053-3056.
303. **Yang, T., G. Segal, S. Abbo, M. Feldman, and H. Fromm.** 1996. Characterization of the calmodulin gene family in wheat: structure, chromosomal location, and evolutionary aspects. *Mol. Gen. Genet.* **252**:648-694.
304. **Yarden, O., and T. Katan.** 1993. Mutations leading to substitutions at amino acids 198 and 200 of beta-tubulin that correlate with benomyl resistance phenotypes of field strains of *Botrytis cinerea*. *Phytopathology.* **83**:1478-1483.
305. **Yaver, D. S., F. Zu, E. J. Golightly, K. M. Brown, S. H. Brown, M. W. Rey, P. Schneider, T. Halkier, K. Mondorf, and H. Dalboge.** 1996. Purification, characterization, molecular cloning, and expression of two laccase genes from the white rot Basidiomycete *Trametes villosa*. *Appl. Environ. Microbiol.* **62**:834-841.
306. **Young, R. A., and R. W. Davis.** 1983. Yeast RNA polymerase II genes: isolation with antibody probes. *Science.* **222**:778-782.
307. **Yun, S.-H., M. L. Berbee, O. C. Yoder, and B. G. Turgeon.** 1999. Evolution of the self-fertile reproductive life style from self-sterile ancestors. *Proc. Natl. Acad. Sci. USA.* **96**:5592-5597.
308. **Zhao, J., and H. S. Kwan.** 1999. Characterization, molecular cloning, and differential expression analysis of laccase genes from the edible mushroom *Lentinula edodes*. *Appl. Environ. Microbiol.* **65**:4908-4913.
309. **Zhou, J., A. Kilian, R. L. Warner, and A. Kleinhofs.** 1995. Variation of nitrate reductase genes in selected grass species. *Genome.* **38**:919-927.
310. **Zhou, J., and A. Kleinhofs.** 1996. Molecular evolution of nitrate reductase genes. *J. Mol. Evol.* **42**:432-442.
311. **Zimmer, E. A., S. L. Martin, S. M. Beverley, Y. W. Kan, and A. C. Wilson.** 1980. Rapid duplication and loss of genes coding for the  $\alpha$ -chains of hemoglobin. *Proc. Natl. Acad. Sci. USA.* **77**:2158-2162.

## 7 TABLES





**Table 1.** Consensus sequences for the 5'- and 3'-splice sites, as well as the putative branch sites for the different types of spliceosomal introns (249).

Intron type	5'-Splice site <sup>1</sup>	Branch site <sup>1</sup>	3'-splice site <sup>1</sup>	Dist. <sup>2</sup>	Freq. <sup>3</sup>
U2-type GT-AG intron	KAG GTRAGT○○○ 71 81 ●●94 71 84 46---	○○○○CTRAY○○○ -----76 81 83-- 91 99	YYYYYYYYYYYYY○TAG G○○ 71 76 78 80 80 80 82 88 87-96●● 52--	10-50+	Common
U12-type GT-AG intron	○○T GTATCCTTT --54 ●●●●●●●96 93 70	TTCCTTAACY○Y 52 81 89●89 96 68-71 74 96	○○○○○○○○○○○○○○○YAG A○○ -----96●● 54--	11-20	1/600
U12-type AT-AC intron	○○○ ATATCCTTT --- ●●●●●●●96 70 93	TTCCTTRACYCY 50 95 95●●●●86 75 85 65 90	○○○○○○○○○○○○○○○YAC ○○○ -----95●96 ---	10-15	1/5000 to 1/10000
U2-type AT-AC intron	ARG ATAAGT○○○ ●●● ●●86●71---	unknown unknown	○○○○○○○○○○○○○○○YAC ○○○ -----86●● ---	n/a	unknown

<sup>1</sup> Splice junctions are indicated by vertical lines (|). Positions with no clear consensus sequences are indicated by open circles (○), whereas R indicates either purine (A or G), Y either pyrimidine (C or T) and K either A or C. Below each of the consensus sequences the degrees of conservation (%) are indicated. Black dots (●) indicate 100 % conservation in all the known sequences and horizontal lines (-) indicate the absence of strong conservation.

<sup>2</sup> Dist. = distance in nucleotide bases from the putative branch site to the 3'-splice junction. n/a = not available.

<sup>3</sup> The approximate frequency at which the intron type occurs (249).

**Table 2.** The taxonomic level and specific problems associated with the use of selected nuclear and mitochondrial protein-coding genes in taxonomic and phylogenetic studies.

Protein	GenBank hits <sup>1</sup>		Taxonomic levels studied	Specific problems experienced <sup>2</sup>
	Fungi	Total		
β-tubulin	802	5810	Species → Eukaryotic kingdoms (5, 11, 63, 75, 92, 142-145, 212, 213, 215, 216, 243, 245, 262, 278, 283, 290)	-Multi-copy (37, 101, 109, 112, 143, 167, 187, 222, 231, 259, 284) -Lateral transfer (260) -Distortion and lack of resolution of phylogenetic relationships due to lineage and site-specific accelerated evolutionary rates (144, 145)
Elongation factor 1α	283	15771	Individual → Eukaryotic and prokaryotic kingdoms (5, 10, 11, 42, 53, 135, 139, 149, 152, 157, 201, 207, 210, 215, 216, 237)	-Multi-copy (139, 206, 233, 237) -Distortion and lack of resolution of phylogenetic relationships due to lineage and site-specific accelerated evolutionary rates (10, 11, 123, 139, 233, 237)
Chitin synthases	246	272	Individuals → Species (140, 154, 191, 283)	-Multi-copy (29, 192, 193, 198, 199, 242, 301)
Actin	240	29930	Species → Eukaryotic kingdoms (4, 11, 19, 68, 87, 117, 157, 207, 221, 295)	-Multi-copy (69, 189, 296, 81) -Distortion of phylogenetic relationships because of lineage specific nucleotide substitution rates (1, 19, 68, 117)
Glyceraldehyde-3-phosphate dehydrogenase	218	5490	Species (2, 11, 18)	-Multi-copy (167, 300) -Distorted inter- and intrakingdom relationships because of lateral gene transfer (32, 45, 84, 118, 169, 258, 282, 195)
Calmodulin	133	22946	Individual → Eukaryotic kingdoms (11, 42, 92, 216, 245)	-Multi-copy (162, 303)
Mating type idiomorphs	129	123	Species <sup>3</sup> (256, 264, 279, 307)	-Sequence information from isolates with opposite mating types is not combinable (264)
Histone H3	104	4773	Species → Eukaryotic kingdoms (63, 179, 262, 263, 272, 273, 292)	-Multi-copy (79, 114, 179, 197, 219, 272, 273, 292)
Laccases	92	482	N/u	-Multi-copy (76, 95, 196, 305, 308)
70-kDa Heat-shock-protein (HSP70)	90	1140	Class → Eukaryotic and prokaryotic kingdoms (11, 27, 77, 94, 122, 157, 207, 245, 261)	-Multi-copy (261)

**Table 2.** Continued.

Protein	GenBank hits <sup>1</sup>		Taxonomic levels studied	Specific problems experienced <sup>2</sup>
	Fungi	Total		
Glucoamylase	69	128	Species <sup>3</sup> (92)	-Multi-copy (62)
Polygalacturonase	63	439	Species <sup>3</sup> (92)	-Multi-copy (40, 297)
<i>O</i> -methyltransferase	53	796	Species <sup>3</sup> (92)	
$\alpha$ -tubulin	51	6738	Species → Eukaryotic kingdoms (142, 144, 145)	-Multi-copy (143, 153, 167) -Distortion and lack of resolution of phylogenetic relationships due to lineage and site-specific accelerated evolutionary rates (144, 145)
ATPase subunit 6	50	754	Species → Class (11, 155, 207)	-Presence of hybrid genes (223) -Interspecific lateral transfer (223)
Phosphate permease	50	4	Species <sup>3</sup> (215)	
Glutamate dehydrogenase	49	1107	N/u	-Multi-copy (14)
ATPase subunit 9	46	93	Species → Eukaryotic and prokaryotic kingdoms (207, 232)	-Multi-copy (232)
Elongation factor 2	45	1970	Species → Eukaryotic and prokaryotic kingdoms (116, 123, 135, 139, 157, 201, 207)	-Multi-copy (139) -Distortion and lack of resolution of phylogenetic relationships due to lineage and site-specific accelerated evolutionary rates (123)
Histone H4	39	1287	Species → Eukaryotic kingdoms (63, 154, 179, 272, 283)	-Multi-copy (13, 79, 114, 186, 197, 219, 292)
$\gamma$ -tubulin	39	428	Species → Eukaryotic kingdoms (142, 144, 145)	-Distortion and lack of resolution of phylogenetic relationships due to lineage and site-specific accelerated evolutionary rates (145)
RNA polymerase II second largest subunit	33	236	Species → Eukaryotic and prokaryotic kingdoms (56, 133, 157, 170, 207, 254, 276)	
Histone H2A	33	2701	Species → Eukaryotic kingdoms (12, 272, 280)	-Multi-copy (79, 114, 148, 186, 197, 219, 272)

**Table 2.** Continued.

Protein	GenBank hits <sup>1</sup>		Taxonomic levels studied	Specific problems experienced <sup>2</sup>
	Fungi	Total		
Phosphoglycerate kinase	31	1360	Species → Eukaryotic kingdoms (11, 48)	-Multi-copy (167)
Nitrate reductase	31	338	Species → Eukaryotic kingdoms (92, 154, 283, 309, 310)	-Multi-copy (309)
Histone H2B	24	1028	Species → Eukaryotic kingdoms (12, 272)	-Multi-copy (79, 105, 114, 186, 197, 219)
Adenylate kinase	20	1062	N/u	-Multi-copy (89)
Eukaryotic initiation factors	20	2045	Species → Eukaryotic kingdoms (157)	
Malate dehydrogenase	20	2184	Species → Eukaryotic kingdoms (11, 134, 180)	
Glucose-6-phosphate dehydrogenase	15	594	Species <sup>3</sup> (92, 285)	
Serine proteinase	15	630	Species <sup>3</sup> (154)	
Orotidine 5'-monophosphate decarboxylase	15	92	Species <sup>3</sup> (154, 230)	
Serine-threonine kinase domain of protein kinases	14	257	Class → Eukaryotic kingdoms (156, 245)	-Multi-copy (156)
RNA polymerase II largest subunit ( <i>RPB1</i> )	12	268	Species → Eukaryotic and prokaryotic kingdoms (15, 51, 123, 133, 157, 207, 227, 276)	
Cytochrome subunits	10	449	Individuals → Eukaryotic and prokaryotic kingdoms (3, 86, 102, 138, 146, 155, 175, 203, 233, 241, 288)	-Multi-copy (167) -Distortion of phylogenetic relationships due to lineage specific accelerated evolutionary rates (155, 233, 298)



**Table 2.** Continued.

Protein	GenBank hits <sup>1</sup>		Taxonomic levels studied	Specific problems experienced <sup>2</sup>
	Fungi	Total		
Dihydroorotase	10	100	Eukaryotic and prokaryotic kingdoms (281)	-Multi-copy (281)
Trichothecene 3- <i>O</i> -acetyltransferase	9	9	Species <sup>3</sup> (215)	
UTP-ammonia ligase	8	2	Species <sup>3</sup> (215)	
Protease I	7	60	Species <sup>3</sup> (154)	
Triose phosphate isomerase	6	158	Class → Eukaryotic kingdoms (77, 207, 208)	-Multi-copy(167)
Valyl-tRNA synthetase	6	494	Class → Eukaryotic kingdoms (77)	
Aldehyde reductase	4	216	Class → Eukaryotic kingdoms (77, 147)	

<sup>1</sup> Total number of GenBank entries and only those associated with fungi (Updated November 25<sup>th</sup> 2000).

<sup>2</sup> Multi-copy refers to the presence of either non-orthologous or pseudo genes.

<sup>3</sup> Use of the protein-coding gene sequence has only been tested at the level indicated by these authors. N/u = gene not used for phylogeny.

## 8 FIGURES

**Figure 1.** Intron distribution matrix for selected  $\beta$ -tubulin genes in eukaryotes [modified from Dibb and Newman (58) and Liaud et al. (168)]. Intron positions and phases are indicated as defined by Dibb and Newman (58). The intron at position 5, for example, is phase 0, which means that codon number 5 is preceded by an intron. Phase 0 introns are indicated in blue by ①. The intron at position 10 is phase 1, which means that codon number 10 is split by an intron after the first base. Phase 1 introns are indicated in red by ②. The intron at position 21 is phase 2, which means that codon number 21 are split by an intron after the second base. Phase 2 introns are indicated in black by ③. A vertical line (-) indicates the absence of an intron. GenBank accession numbers are indicated in parentheses. For the correct intron positions in *Trichoderma viride* (GenBank accession number Z15054), a value of two should be added to all positions, since this strain has an insertion of two codon residues at the beginning of the sequence. All the intron positions after number 133 in *Histoplasma capsulatum* (GenBank accession number AH003038) should be increased by one, because of a single residue insertion. All the intron positions after number 350 in the human TUB4Q  $\beta$ -tubulin gene (GenBank accession number U83668) should be decreased by one because of a residue deletion.





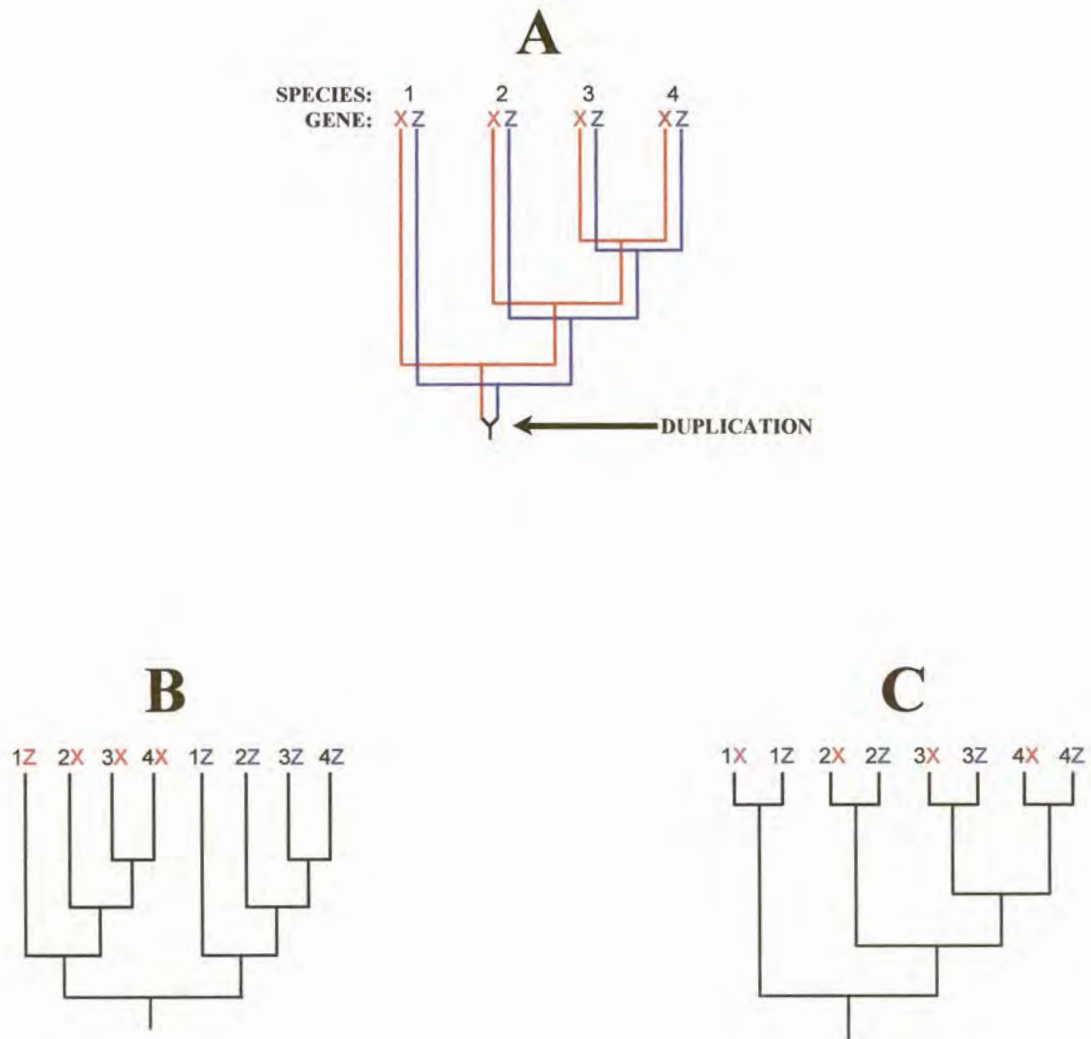

**Figure 2.** Evolutionary relationships among the hypothetical species 1, 2, 3, and 4 (240). A gene duplication event prior to the radiation of these species gave rise to a simple multigene family consisting of two genes (X and Z). **A:** The 'true phylogeny' reflecting the orthologous relationships among, for example, 1X, 2X, 3X and 4X, as well as the paralogous relationships between 1X and 1Z. **B:** The evolutionary relationships among the different genes and species prior to, or in the absence of concerted evolution. The tree is drawn in the standard output format of phylogenetic analyses software such as PAUP\*4.0b (267). **C:** The evolutionary relationships among the different genes and species after, or in the presence of high levels of concerted evolution. The tree is drawn in the standard output format of phylogenetic analysis software.



# CHAPTER 2

## DIFFERENTIATION OF *FUSARIUM SUBGLUTINANS* F. SP. *PINI* BY HISTONE GENE SEQUENCE DATA

E.T. Steenkamp<sup>1</sup>, T.A. Coutinho<sup>1</sup>, B.D. Wingfield<sup>1</sup>,  
M.J. Wingfield<sup>1</sup> and W.F.O. Marasas<sup>2</sup>

Tree Pathology Co-operative Programme, Forestry and  
Agricultural Biotechnology Institute (FABI), Departments of  
Genetics, Microbiology and Plant Pathology, University of  
Pretoria, Pretoria, 0002, South Africa<sup>1</sup>;  
PROMEC, Medical Research Council, P.O. Box 19070, Tygerberg  
7505, South Africa<sup>2</sup>.

**Published:** Steenkamp et al. *Applied and Environmental  
Microbiology* (1999) **65**(8), 3401-3406.

## ABSTRACT

*Fusarium subglutinans* f. sp. *pini* (= *F. circinatum*) is a pathogen of pine and is one of eight mating populations (i.e., biological species) in the *Gibberella fujikuroi* species complex. This species complex includes *F. thapsinum*, *F. moniliforme*, (= *F. verticillioides*), *F. nygamai* and *F. proliferatum*, as well as *F. subglutinans* associated with sugarcane, maize, mango and pineapple. Differentiating these forms of *F. subglutinans* usually requires pathogenicity tests, which are often time-consuming and inconclusive. Our objective was to develop a technique to differentiate isolates of *F. subglutinans* f. sp. *pini* from other isolates identified as *F. subglutinans*. We sequenced the histone *H3* gene from a representative set of *Fusarium* isolates. The *H3* gene sequence was conserved and contained two introns in all the isolates studied. From both the intron and exon sequence data, we developed a PCR-RFLP technique that reliably distinguishes *F. subglutinans* f. sp. *pini* from strains associated with the other hosts, as well as the remaining biological species in the *G. fujikuroi* species complex.



## INTRODUCTION

*Fusarium subglutinans* f. sp. *pini* is an important pathogen of pine that causes pitch canker in mature trees (6, 13) and root rot and damping off in seedlings (2, 34). This fungus can be spread by both infected seedlings and seed (1, 28). The management of *F. subglutinans* f. sp. *pini* would be greatly improved if a quick screening method were available for seed and nursery stock.

*F. subglutinans* f. sp. *pini* represents one of eight mating populations (i.e., biological species) in the *Gibberella fujikuroi* species complex (6, 23). Three of these mating populations, B, E and H (*F. subglutinans* f. sp. *pini*), have *F. subglutinans* anamorphs (5, 14, 19, 20). Strains of *Fusarium* isolated from pineapple (*F. subglutinans* f. sp. *ananas*) and mango, for which a teleomorph is not known, also have *F. subglutinans* anamorphs (27, 32, 33).

Distinguishing *F. subglutinans* f. sp. *pini* from the other species in the *G. fujikuroi* complex usually requires pathogenicity tests or sexual crosses with known mating tester strains (6, 7, 35). These assays are time-consuming, labor-intensive, and do not always yield clear-cut answers. Molecular tools such as random amplified polymorphic DNAs (RAPDs) (9, 35, 36), mitochondrial restriction fragment length polymorphisms (RFLPs) (7) and ribosomal DNA (rDNA) internal transcribed spacer (ITS1 and ITS2) sequences (25, 37) have been tested for their efficacy in differentiating *F. subglutinans* f. sp. *pini* from other isolates of *F. subglutinans*. Because of the technical difficulties associated with mitochondrial RFLPs and the low repeatability of RAPD data, we do not consider these techniques useful for diagnostic purposes. Furthermore, two different copies of the ITS2 region have been identified in the same isolate within some of the species in the *G. fujikuroi* complex (25, 37), and a reliable diagnostic technique based on these sequences could not be developed. Alternative regions such as the histone and  $\beta$ -tubulin genes might be used more effectively.

O'Donnell et al. (26) used DNA sequence of the nuclear rDNA large subunit, mitochondrial small subunit, and  $\beta$ -tubulin, to develop a phylogeny that includes 36 taxa in the *G. fujikuroi* species complex. These sequences may potentially be useful for diagnostics, but we began our study prior to publication of the O'Donnell et al. (26) phylogeny. We used an alternative region of the genome, the histone *H3* gene, to distinguish *F. subglutinans* f. sp. *pini* from other isolates of *F. subglutinans*.

Histone genes encode the histone proteins. These proteins are the major constituents of chromatin (16, 21) and four histone proteins make up the nucleosomal core, H2A, H2B, H3 and H4 (17). The gene encoding the H3 protein is well conserved, especially at the amino acid level (12, 31). The presence of introns enhances also its value in taxonomic and phylogenetic studies of closely related organisms (8, 38). Although the *H4* histone gene also has these characteristics, it is



generally too conserved to be suitable for evolutionary studies (30).

Our objectives in this study were (i) to sequence the histone *H3* gene from various strains in the *G. fujikuroi* species complex, (ii) to compare the relationships thus determined with those established using other sequences, and (iii) to develop a PCR-RFLP procedure, based on the histone *H3* gene sequences, for the routine identification of *F. subglutinans* f. sp. *pini*.

## MATERIALS AND METHODS

**Fungal isolates.** All isolates were maintained on 2% (wt/vol) malt extract agar (Biolab Diagnostics Ltd., Fedlife Park, Midrand, South Africa) in the culture collections of the Forestry and Agricultural Biotechnology Institute at the University of Pretoria, Pretoria, South Africa and the Medical Research Council at Tygerberg, South Africa. We examined 42 *Fusarium* isolates including *F. subglutinans* f. sp. *pini*, pathogenic to pine; *F. subglutinans* f. sp. *ananas*, pathogenic to pineapple; *F. subglutinans* isolates associated with maize and mango; and the mating type tester strains from all eight mating populations in the *G. fujikuroi* species complex (Table 1). To test the efficacy of the PCR-RFLP technique for use as a species diagnostic technique (see below), we tested 60 strains of the H-mating population identified by Britz et al. (5) and 80 strains representing populations A to F identified by Yan et al. (39). These strains were reassorted and then encoded so that the assays were done in a blind manner.

**DNA isolation.** Flasks containing 100 ml malt extract broth (2% [wt/vol]) (Biolab) were inoculated with 1-ml spore suspensions (>1,000 spores/ml). After 2 weeks of static incubation at room temperature (20 to 25°C), mycelium was harvested by filtration through Whatman no. 1 filter paper (Whatman BioSystems Ltd., Maidstone, Kent, United Kingdom). Harvested fungal tissue was ground to a powder in liquid nitrogen with a mortar and pestle and homogenized in extraction buffer, containing 5% (wt/vol) CTAB (*N*-cetyl-*N,N,N*-trimethyl-ammonium bromide), 1.4 M NaCl, 0.2% (vol/vol) 2-mercaptoethanol, 20 mM EDTA, 100 mM Tris-HCl (pH 8.0) and 1% (wt/vol) polyvinylpyrrolidone. This homogenate was incubated at 60°C for 1 h and centrifuged (16,000 x *g*) at room temperature. We performed phenol-isoamyl alcohol-chloroform (25:1:24) extractions and removed residual phenol with an additional chloroform extraction. Nucleic acids were precipitated with 0.1 volume of 3 M sodium acetate (pH 5.2) and 0.6 volume of 2-propanol, followed by incubation at 4°C overnight. Precipitated DNA was centrifuged (16,000 x *g*), washed with 70% ethanol and resuspended in deionized water. This protocol is a variation of the one developed by Murray and Thompson (22).

**PCR amplification.** PCR amplification was performed as described by Glass and Donaldson (12) with the primers H3-1a (5'-actaagcagaccgcccgcagg-3') and H3-1b (5'-gcgggcgagctggatgcctt-3'). These primers were constructed to flank at least one intron and amplify approximately 450 bp of the *Neurospora crassa* histone *H3* gene. Each PCR reaction contained 1 mM deoxynucleotide triphosphates (0.25 mM of each), 2.5 mM MgCl<sub>2</sub>, 0.2 μM H3-1a, 0.2 μM H3-1b, 0.25 ng/μl DNA, 0.05 U/μl Super-Therm DNA polymerase (Southern Cross Biotechnology (Pty) Ltd., Cape Town, South Africa) and 1 x Super-Therm reaction buffer. PCR reactions were overlaid with mineral oil and reactions were performed on an Omnigene thermocycler (Hybaid,

Middlesex, United Kingdom), with an initial denaturation step of 1 min at 92°C. This was followed by 30 cycles of denaturing at 92°C (1 min), annealing at 68°C (1 min), and elongation at 72°C (1 min). A final extension was performed at 72°C for 5 min.

**DNA sequencing.** PCR products were purified with a QIAquick PCR Purification Kit (Qiagen GmbH, Germany). Histone *H3* gene fragments from 42 *Fusarium* isolates included in this study, were sequenced (see Table 1 for GenBank accession numbers) in both directions with the primers H3-1a and H3-1b. Reactions were performed on an ABI PRISM™ 377 automated DNA sequencer with an ABI PRISM™ Dye Terminator Cycle Sequencing Ready Reaction Kit (Perkin Elmer, Warrington, United Kingdom).

Sequence Navigator™ version 1.0.1. (Perkin Elmer, Applied BioSystems, Inc. Foster City, CA) was used for translation of DNA sequences to amino acid sequences. DNA sequences were aligned manually by inserting gaps (see Appendix 1 for aligned sequences) and phylogenetic analyses were performed with PAUP (Phylogenetic Analysis Using Parsimony) version 4.0b1 (29). Each gap was treated as a fifth character (newstate) in heuristic searches, with tree-bisection-reconnection branch swapping and MUL TREES (saving of all optimal trees) effective. Bootstrap analyses were based on 1,000 replications. *F. oxysporum* (MRC 6212) was used as an outgroup.

**Sexual compatibility tests.** The seven *F. subglutinans* isolates recovered from maize in South Africa (Table 1) were crossed with the mating population E tester strains and with one another in all possible pairwise combinations (5, 18). Crosses were scored as positive when ascospores were observed exuding from perithecia.

**PCR-RFLP technique.** Amplified DNA was digested with two restriction enzymes, *Cfo*1 and *Dde*1 (Boehringer Mannheim South Africa Pty. Ltd.). Digestions were performed consecutively by adding 5 units of *Cfo*1 to 15 µl of unpurified PCR product (3). After 3 h of incubation at 37°C, we added 5 units of *Dde*1 and adjusted the sodium chloride concentration to 100 mM. These digestion reaction mixtures were then incubated at 37°C for an additional 5 h. We resolved PCR-RFLP profiles on 3% (wt/vol) agarose gels (Promega Corporation, Madison, WI; Molecular Biology Grade agarose) containing ethidium bromide (0.2 µg/ml). Electrophoresis was performed at 3 V/cm (room temperature) with electrophoresis buffer, containing 4.5 mM Tris, 4.5 mM boric acid, and 1 mM EDTA (pH 8.0). Nucleic acids were visualized with an UV transilluminator (302 nm).

**Verification of technique.** To test the efficacy of the PCR-RFLP technique described here, histone *H3* gene PCR products from 60 strains representing mating population H and 80 strains representing the mating populations A to F were amplified, digested and electrophoresed as described above. We compared the resulting PCR-RFLP profiles to those generated from the representatives of the *G. fujikuroi* species complex.

## RESULTS

**DNA sequencing.** The *Fusarium* histone *H3* gene fragment ranged from 519 to 527 bp in length and contained two introns (Intron 1 and Intron 2), the positions of which are conserved. Intron 1 was 83 bp in length for strains from mating population H, *F. oxysporum* and *F. subglutinans* f. sp. *ananas*; 81 bp long for mating populations C and D, as well as *F. subglutinans* isolates from mango; 85 bp long for mating populations A and G, 82 bp long for mating population E and F, as well as *F. subglutinans* isolated from maize; and 77 bp long for mating population B. Intron 2 was 57 bp long for all of the isolates, except for *F. oxysporum*, for which it was 58 bp long.

The coding regions of the *Fusarium H3* genes were highly conserved, and we observed no deletions or insertions. We detected no differences in amino acid sequence because variation within the coding sequence was generally limited to the third position within the codon. The *Fusarium* histone *H3* amino acid sequence differed from that of *N. crassa* (GenBank Accession number CAA25761) only at position 91 (A→L) (38), whereas that of *Aspergillus nidulans* (GenBank Accession number CAA39154) differed at two positions, 29 and 99 (both S→A) (10). Additionally, *N. crassa* has a single intron at the same position as the *Fusarium* Intron 2, but its sequence was quite different from that of Intron 2.

Phylogenetic analysis with PAUP 4.0b1 generated a single most parsimonious tree from 469 bp of aligned DNA sequence (Fig. 1). This tree was comprised of two distinct clades. Clade 1 included isolates from mating populations H and E, as well as isolates of *F. subglutinans* f. sp. *ananas* and *F. subglutinans* isolates from maize. The bootstrap value for this clade indicated 96% unity. Clade 2 included isolates from mating populations A, B, C, D, F and G, as well as *F. subglutinans* isolates from mango. The support for unity of this clade was 70%.

Two subgroups made up Clade 1 (Fig. 1). The first subgroup included *F. subglutinans* f. sp. *ananas*. The second subgroup included *F. subglutinans* f. sp. *pini* and isolates from mating population E, clustering together with 96% certainty. Clade 2 was subdivided into two smaller subgroups, one of which included isolates from mating populations B, C and D, as well as *F. subglutinans* isolates from mango, with 87% support. The second subgroup in Clade 2 contained isolates from mating populations A, F and G, with 71% support.

**Sexual compatibility tests.** Three of the *F. subglutinans* isolates associated with maize (MRC 1077, MRC 837 and MRC 714) were sexually compatible with one of the mating type tester strains for mating population E (MRC 6483). The remaining four isolates did not cross with one another or either of the tester strains.

**PCR-RFLP technique.** PCR-RFLP analysis of the amplified histone *H3* gene products with *Dde*1 and *Cfo*1 enabled us to distinguish *F. subglutinans* f. sp. *pini* from the rest of the isolates

included in this study (Fig. 2). Unique PCR-RFLP profiles were generated for each group included in this study, except for mating populations C and D, mating population G and *F. subglutinans* isolated from mango. From the restriction enzyme profiles we constructed restriction maps for all the host-specific groups of *F. subglutinans*, as well as *F. moniliforme*, *F. proliferatum*, *F. thapsinum* and *F. nygamai* (Fig. 3).

**Verification of technique.** All 60 of the H-mating population strains were positively identified as *F. subglutinans* f. sp. *pini* in a blind test of the PCR-RFLP technique. We identified none of the strains from the collection of Yan et al. (39) as *F. subglutinans* f. sp. *pini* and the expected profiles were generated for each of their representatives of mating populations A, B, E and F. The blind test on 140 samples was 100% successful, providing 95% confidence that the error rate for this test is less than 2%.



## DISCUSSION

In this study, we were able to distinguish *F. subglutinans* f. sp. *pini* (mating population H) from *F. subglutinans* isolates associated with mango, maize (mating population E), sugarcane (mating population B), and pineapple, as well as *F. moniliforme* (mating populations A), *F. proliferatum* (mating populations C and D), *F. thapsinum* (mating population F) and *F. nygamai* (mating population G). The PCR-RFLP technique has been used successfully by the Tree Pathology Co-operative Programme diagnostic clinic, to identify isolates of *F. subglutinans* f. sp. *pini* for the last year. Seven outbreaks of root rot in South African nurseries have been correctly diagnosed as being caused by *F. subglutinans* f. sp. *pini* (4). We thus have confidence that this technique is robust and can be used with a high degree of certainty.

Phylogenetic analyses with the *Fusarium* histone *H3* gene sequence data generated a phylogram (Fig. 1) that was similar to those produced by O'Donnell et al. (26). The results presented here and those based on  $\beta$ -tubulin and mitochondrial small subunit DNA sequences (26) are similar to those obtained with isozymes (15) in two aspects. First, mating populations C and D form a closely related group in all cases. Second, mating population E is phylogenetically distinct from mating populations A, B, C, D, F, and G. There are, however, two major differences between the DNA based phylogenies and the one based on isozymes. With isozymes Huss et al. (15) showed mating populations C and D to be most closely related to mating population G. The DNA based phylogenies (26, this study), however, indicated that mating population G is most closely related to mating populations A and F, and that these three mating populations form a distinct cluster separate from both mating populations C and D. Also, in contrast with the results from the isozyme study (15), both DNA based phylogenies (26, this study) indicated that mating populations C and D are most closely related to mating population B.

*F. subglutinans* f. sp. *pini* has previously been reported to belong to mating population B (29), but our results and those presented by Britz et al. (5) and O'Donnell et al. (26) suggest otherwise. Nirenberg and O'Donnell (24) elevated this fungus to species level and provided the name *F. circinatum* (teleomorph = *G. circinata*) for it. Although our results are consistent with those of O'Donnell et al. (26) and support the placement of *F. subglutinans* f. sp. *pini* in a distinct taxon, the distinguishing morphological characters reported by Nirenberg and O'Donnell (24) appear to be inadequate to make definite identifications of the fungus (5).

*Fusarium subglutinans* f. sp. *pini*, *F. subglutinans* f. sp. *ananas*, mating population E, and *F. subglutinans* isolated from maize, are closely related to each other and are included in Clade 1. Although some of the *F. subglutinans* isolates from maize and those belonging to mating population E appeared in two separate but closely related groups, this separation is caused by only

two nucleotide base pair differences. Since some individuals from both of these groups could cross with one of the mating type E testers, we do not believe that the second cluster of isolates from maize represents a separate mating population. The overall appearance of Clade 1 corresponds to that of the so-called 'American Clade' described by O'Donnell et al. (26). This similarity suggests an equivalence of *F. subglutinans* f. sp. *pini* and *F. circinatum*, as well as *F. subglutinans* f. sp. *ananas* and *F. guttiforme*.

The two subgroups that constitute Clade 2 in our study, correspond to the 'African' and 'Asian' clades of O'Donnell et al. (26). The 'African' clade includes mating populations A, F, and G, whereas the 'Asian' clade includes mating populations B, C and D. The latter clade also includes the *F. subglutinans* isolates associated with mango, which are phylogenetically separate from *F. subglutinans* associated with maize, pineapple and pine, but phylogenetically more closely related to *F. subglutinans* from the B-mating population (Fig.1).

The results of this study and those of O'Donnell et al. (26) have identified a number of conserved genes that are useful for phylogenetic and taxonomic studies among species of *Fusarium*. The *H3* gene, as well as the  $\beta$ -tubulin gene, allows for a higher degree of resolution than the rDNA ITS1 and ITS2. Species, previously considered too closely related for separation into distinct groups, can now be separated based on histone or  $\beta$ -tubulin gene sequence. Moreover, rapid identification of fungi such as the pitch canker pathogen is now possible using a PCR-RFLP technique based on the histone *H3* gene sequence.

## REFERENCES

1. **Anderson, R. L., E. Belcher, and T. Miller.** 1984. Occurrence of fungi inside slash pine seeds produced in seed orchards in the United States. *Seed Sci. Technol.* **12**:795-799.
2. **Barnard, E. L., and G. M. Blakeslee.** 1980. Pitch canker of slash pine seedlings: a new disease in forest tree nurseries. *Plant Dis.* **64**:695-696.
3. **Blanck, A., B. Glück, R. Wartbichler, S. Bender, M. Pöll, and A. Brandl.** 1997. Activity of restriction enzymes in a PCR mix. *Biochemica.* **3**:25.
4. **Britz, H.** Personal communication.
5. **Britz, H., T. A. Coutinho, M. J. Wingfield, W. F. O. Marasas, T. R. Gordon, and J. F. Leslie.** 1999. *Fusarium subglutinans* f. sp. *pini* represents a distinct mating population in the *Gibberella fujikuroi* species complex. *Appl. Environ. Microbiol.* **65**:1198-1201.
6. **Correll, J. C., T. R. Gordon, A. H. McCain, J. W. Fox, C. S. Koehler, D. L. Wood, and M. E. Schultz.** 1991. Pitch canker disease in California: pathogenicity, distribution and canker development on Monterey pine (*Pinus radiata*). *Plant Dis.* **75**:676-682.
7. **Correll, J. C., T. R. Gordon, and A. H. McCain.** 1992. Genetic diversity in California and Florida populations of the pitch canker fungus of *Fusarium subglutinans* f. sp. *pini*. *Phytopathology.* **82**:415-420.
8. **Donaldson, G. C., L. A. Ball, P. E. Axelrood, and N. L. Glass.** 1995. Primer sets developed to amplify conserved genes from filamentous ascomycetes are useful in differentiating *Fusarium* species associated with conifer. *Appl. Environ. Microbiol.* **61**:1331-1340.
9. **DuTeau, N. M., and J. F. Leslie.** 1991. RAPD markers for *Gibberella fujikuroi* (*Fusarium* section *Liseola*). *Fungal Genet. Newsl.* **38**:37.
10. **Ehinger, A., S. H. Denison, and G. S. May.** 1990. Sequence, organization and expression of the core histone genes of *Aspergillus nidulans*. *Mol. Gen. Genet.* **222**:416-424.
11. **Gerlach, W., and H. I. Nirenberg.** 1982. The genus *Fusarium* – A pictorial atlas. *Mitt. Biol. Bundesanst. Land-Forstwirtschaft. Berlin-Dahlem.* **209**:1-406.
12. **Glass, N. L., and G. C. Donaldson.** 1995. Development of primer sets designed for use with PCR to amplify conserved genes from filamentous ascomycetes. *Appl. Environ. Microbiol.* **61**:1323-1330.
13. **Hepting, G. H., and E. R. Roth.** 1946. Pitch canker, a new disease of some southern pines. *J. Forest.* **44**:742-744.
14. **Hsieh, W. H., S. N. Smith, and W. C. Snyder.** 1977. Mating groups in *Fusarium moniliforme*. *Phytopathology.* **67**:1041-1043.

15. **Huss, M. J., C. L. Campbell, D. B. Jennings, and J. F. Leslie.** 1996. Isozyme variation among biological species in the *Gibberella fujikuroi* species complex (*Fusarium* section *Liseola*). *Appl. Environ. Microbiol.* **62**:3750-3656.
16. **Igo-Kemenes, T., W. Horz, and H. G. Zachau.** 1982. Chromatin. *Annu. Rev. Biochem.* **51**:89-121.
17. **Isenberg, I.** 1979. Histones. *Annu. Rev. Biochem.* **48**:159-191.
18. **Klittich, C. J. R., and J. F. Leslie.** 1988. Nitrate reduction mutants of *Fusarium moniliforme* (*Gibberella fujikuroi*). *Genetics.* **118**:417-423.
19. **Kuhlman, E. G.** 1982. Varieties of *Gibberella fujikuroi* with anamorphs in *Fusarium* section *Liseola*. *Mycologia.* **74**:756-768.
20. **Leslie, J. F.** 1995. *Gibberella fujikuroi*: available populations and variable traits. *Can. J. Bot.* **73**:S282-S291.
21. **McGee, J. D., and G. Felsenfeld.** 1980. Nucleosome structure. *Annu. Rev. Biochem.* **49**:1115-1156.
22. **Murray, M. G., and W. F. Thompson.** 1980. Rapid isolation of high molecular weight plant DNA. *Nucleic Acids Res.* **8**:4321-4325.
23. **Nelson, P. E., T. A. Toussoun, and W. F. O. Marasas.** 1983. *Fusarium* species: An illustrated manual of identification. Pennsylvania State University Press, University Park.
24. **Nirenberg, H. I., and K. O'Donnell.** 1998. New *Fusarium* species and combinations within the *Gibberella fujikuroi* species complex. *Mycologia.* **90**:434-458.
25. **O'Donnell, K., and E. Cigelnik.** 1997. Two divergent intragenomic rDNA ITS2 types within a monophyletic lineage of the fungus *Fusarium* are nonorthologous. *Mol. Phylogenet. Evol.* **7**:103-117.
26. **O'Donnell, K., E. Cigelnik, and H. I. Nirenberg.** 1998. Molecular systematics and phylogeography of the *Gibberella fujikuroi* species complex. *Mycologia.* **90**:465-493.
27. **Rohrbach, K. G., and J. B. Pfeiffer.** 1976. Susceptibility of pineapple cultivars to fruit disease incited by *Penicillium funiculosum* and *Fusarium moniliforme*. *Phytopathology* **66**:1386-1390.
28. **Storer, A. J., T. R. Gordon, and S. L. Clark.** 1998. Association of the pitch canker fungus, *Fusarium subglutinans* f. sp. *pini*, with Monterey pine seeds and seedlings in California. *Plant Pathol.* **47**:649-656.
29. **Swofford, D. L.** 1998. PAUP Phylogenetic analysis using parsimony version 4.0b1. Sinauer Associates, Sunderland, Massachusetts.
30. **Tabata, T., S. Kimiko, and M. Iwabuchi.** 1983. The structural organization and DNA sequence of wheat H4. *Nucleic Acids Res.* **11**:5865-5875.

31. **Thatcher, T. H., J. MacGaffey, J. Bowen, S. Horowitz, D. L. Shapiro, and M. A. Gorovsky.** 1994. Independent evolutionary origin of histone H3.3-like variants of animals and *Tetrahymena*. *Nucleic Acids Res.* **22**:180-186.
32. **Varma, A., V. C. Lele, S. P. Raychaudhuri, A. Ram, and A. Sang.** 1974. Mango malformation: a fungal disease. *Phytopathol. Z.* **79**:254-257.
33. **Ventura, J. A., L. Zambolim, and R. L. Gilbertson.** 1993. Pathogenicity of *Fusarium subglutinans* to pineapples. *Fitopatol. Brasil. Supl.* **18**:280.
34. **Viljoen, A., M. J. Wingfield, and W. F. O. Marasas.** 1994. First report of *Fusarium subglutinans* f. sp. *pini* on pine seedlings in South Africa. *Plant Dis.* **78**:309-312.
35. **Viljoen, A., M. J. Wingfield, and W. F. O. Marasas.** 1997. Characterization of *Fusarium subglutinans* f. sp. *pini* causing root disease of *Pinus patula* seedlings in South Africa. *Mycol. Res.* **101**:437-445.
36. **Voigt, K., S. Schleier, and B. Brückner.** 1995. Genetic variability in *Gibberella fujikuroi* and some related species of the genus *Fusarium* based on random amplification of polymorphic DNA (RAPD). *Curr. Genet.* **27**:528-535.
37. **Waalwijk, C., J. R. A. de Koning, R. P. Baayen, and W. Gams.** 1996. Discordant groupings of *Fusarium* spp. from the sections *Elegans*, *Liseola* and *Dlaminia* based on ribosomal ITS1 and ITS2 sequences. *Mycologia.* **88**:361-328.
38. **Woudt, L. P., A. Pastink, E. Kempers-Veenstra, A. E. M. Jansen, W. H. Mager, and R. J. Planta.** 1983. The gene encoding histone H3 and H4 in *Neurospora crassa* are unique and contain intervening sequences. *Nucleic Acids Res.* **11**:5347-5360.
39. **Yan, K, M. D. Dickman, J. R. Xu, and J. F. Leslie.** 1993. Sensitivity of field strains of *Gibberella fujikuroi* (*Fusarium* section *Liseola*) to benomyl and hygromycin B. *Mycologia.* **85**:206-213.



**Table 1.** Origin and host of the different *Fusarium* isolates from the *Gibberella fujikuroi* (Sawada) Wollenw. species complex used in this study.

Mating population	Species <sup>1</sup>	Isolate(s) <sup>2</sup>	Host and/or origin	Source	GenBank accession no.
A	<i>F. moniliforme</i> Sheldon	MRC 6191; KSU 0999; PEN M3703	Maize, United States	J. F. Leslie	AF150859
A	<i>F. moniliforme</i>	MRC 6155; KSU 0149; PEN M3125	Maize, United States	J. F. Leslie	AF150858
B	<i>F. subglutinans</i> (Wollenw. and Reinking) Nelson, Toussoun and Marasas	MRC 6524; KSU 3852; PEN M6865	Laboratory cross	J. F. Leslie	AF150861
B	<i>F. subglutinans</i>	MRC 6525; KSU 3853; PEN M6866	Laboratory cross	J. F. Leslie	AF150860
C	<i>F. proliferatum</i> (Matsushima) Nirenberg	MRC 6570; KSU 4921	Rice, Taiwan	J. F. Leslie	AF150873
C	<i>F. proliferatum</i>	MRC 6571; KSU 4922	Rice, Taiwan	J. F. Leslie	AF150872
D	<i>F. proliferatum</i>	MRC 6568; KSU 4853	Laboratory cross	J. F. Leslie	AF150871
D	<i>F. proliferatum</i>	MRC 6569; KSU 4854	Laboratory cross	J. F. Leslie	AF150870
E	<i>F. subglutinans</i>	MRC 6483; KSU 0990; PEN M3696	Maize, United States	J. F. Leslie	AF150845
E	<i>F. subglutinans</i>	MRC 6512; KSU 2192; PEN M3693	Maize, United States	J. F. Leslie	AF150844
F	<i>F. thapsinum</i> Klittich et al.	MRC 6536; KSU 4092;	Laboratory cross	J. F. Leslie	AF150857
F	<i>F. thapsinum</i>	MRC 6537; KSU 4093	Laboratory cross	J. F. Leslie	AF150856
G	<i>F. nygamai</i> Burgess and Trimboli	MRC 7548; KSU 5111	Laboratory cross	J. F. Leslie	AF150854
G	<i>F. nygamai</i>	MRC 7549; KSU 5112	Laboratory cross	J. F. Leslie	AF150855
H	<i>F. subglutinans</i> f. sp. <i>pini</i> Correll et al.	MRC 6209; BBA 69854	Pine, South Africa	A. Viljoen	AF150846
H	<i>F. subglutinans</i> f. sp. <i>pini</i>	MRC 6211	Pine, South Africa	A. Viljoen	AF150847
H	<i>F. subglutinans</i> f. sp. <i>pini</i>	MRC 6213	Pine, South Africa	A. Viljoen	AF150849
H	<i>F. subglutinans</i> f. sp. <i>pini</i>	MRC 6228; PEN M1290	Pine, United States	P. E. Nelson	AF150850
H	<i>F. subglutinans</i> f. sp. <i>pini</i>	MRC 7437; FL 103	Pine, United States	T. R. Gordon	AF150848
H	<i>F. subglutinans</i> f. sp. <i>pini</i>	MRC 7438	Pine, United States	A. Viljoen	AF150851
H	<i>F. subglutinans</i> f. sp. <i>pini</i>	MRC 7439; FL 15	Pine, United States	T. R. Gordon	AF150852
H	<i>F. subglutinans</i> f. sp. <i>pini</i>	MRC 7440; FSP 9	Pine, United States	T. R. Gordon	AF150853
	<i>F. subglutinans</i>	MRC 2730	Mango, South Africa	W. F. O. Marasas	AF150865
	<i>F. subglutinans</i>	MRC 3477	Mango, South Africa	W. F. O. Marasas	AF150868
	<i>F. subglutinans</i>	MRC 3478	Mango, South Africa	W. F. O. Marasas	AF150869
	<i>F. subglutinans</i>	MRC 3479	Mango, South Africa	W. F. O. Marasas	AF150867
	<i>F. subglutinans</i>	MRC 7034	Mango, United States	W. F. O. Marasas	AF150864
	<i>F. subglutinans</i>	MRC 7035	Mango, United States	W. F. O. Marasas	AF150866
	<i>F. subglutinans</i>	MRC 7037	Mango, United States	W. F. O. Marasas	AF150863
	<i>F. subglutinans</i>	MRC 7038	Mango, United States	W. F. O. Marasas	AF150862
E	<i>F. subglutinans</i>	MRC 115	Maize, South Africa	W. F. O. Marasas	AF150843
E	<i>F. subglutinans</i>	MRC 620	Maize, South Africa	W. F. O. Marasas	AF150842
E	<i>F. subglutinans</i>	MRC 714	Maize, South Africa	W. F. O. Marasas	AF150841
E	<i>F. subglutinans</i>	MRC 756	Maize, South Africa	W. F. O. Marasas	AF150839

Table 1. Continued.

Mating population	Species <sup>1</sup>	Isolate(s) <sup>2</sup>	Host and/or origin	Source	GenBank accession no.
E	<i>F. subglutinans</i>	MRC 837	Maize, South Africa	W. F. O. Marasas	AF150840
E	<i>F. subglutinans</i>	MRC 1077	Maize, South Africa	W. F. O. Marasas	AF150837
E	<i>F. subglutinans</i>	MRC 1084	Maize, South Africa	W. F. O. Marasas	AF150838
	<i>F. subglutinans</i> f. sp. <i>ananas</i> Ventura, Zambolim and Gilb.	MRC 6782	Pineapple, Brazil	J. A. Ventura	AF150834
	<i>F. subglutinans</i> f. sp. <i>ananas</i>	MRC 6783	Pineapple, Brazil	J. A. Ventura	AF150833
	<i>F. subglutinans</i> f. sp. <i>ananas</i>	MRC 6784	Pineapple, Brazil	J. A. Ventura	AF150836
	<i>F. subglutinans</i> f. sp. <i>ananas</i>	MRC 6785	Pineapple, Brazil	J. A. Ventura	AF150835
	<i>F. oxysporum</i> Schlecht. emend. Snyder and Hans.	MRC 6212	Pine, South Africa	A. Viljoen	AF150832

<sup>1</sup> Synonyms for *F. moniliforme*, *F. subglutinans* f. sp. *pini* and *F. subglutinans* f. sp. *ananas* are *F. verticillioides* Gerlach and Nirenberg (11), *F. circinatum* Nirenberg and O'Donnell (24) and *F. guttiforme* Nirenberg and O'Donnell (24), respectively. The proposed synonyms for *F. subglutinans* from mating population B and *F. proliferatum* from mating population C are *F. sacchari* O'Donnell and Cigelnik (25) and *F. fujikuroi* Gerlach and Nirenberg (11), respectively.

<sup>2</sup> MRC = W. F. O. Marasas, Programme on Mycotoxins and Experimental Carcinogenesis (PROMEC), Medical Research Council, Tygerberg, South Africa; PEN = P. E. Nelson culture collection, Department of Plant Pathology, Pennsylvania State University, University Park; KSU = J. F. Leslie, Kansas State University, Department of Plant pathology, Manhattan; FL and FSP = T. R. Gordon, Department of Plant Pathology, University of California, Hutchison Hall, Davis; BBA = Biologische Bundesanstalt für Land- und Forstwirtschaft, Berlin, Germany.

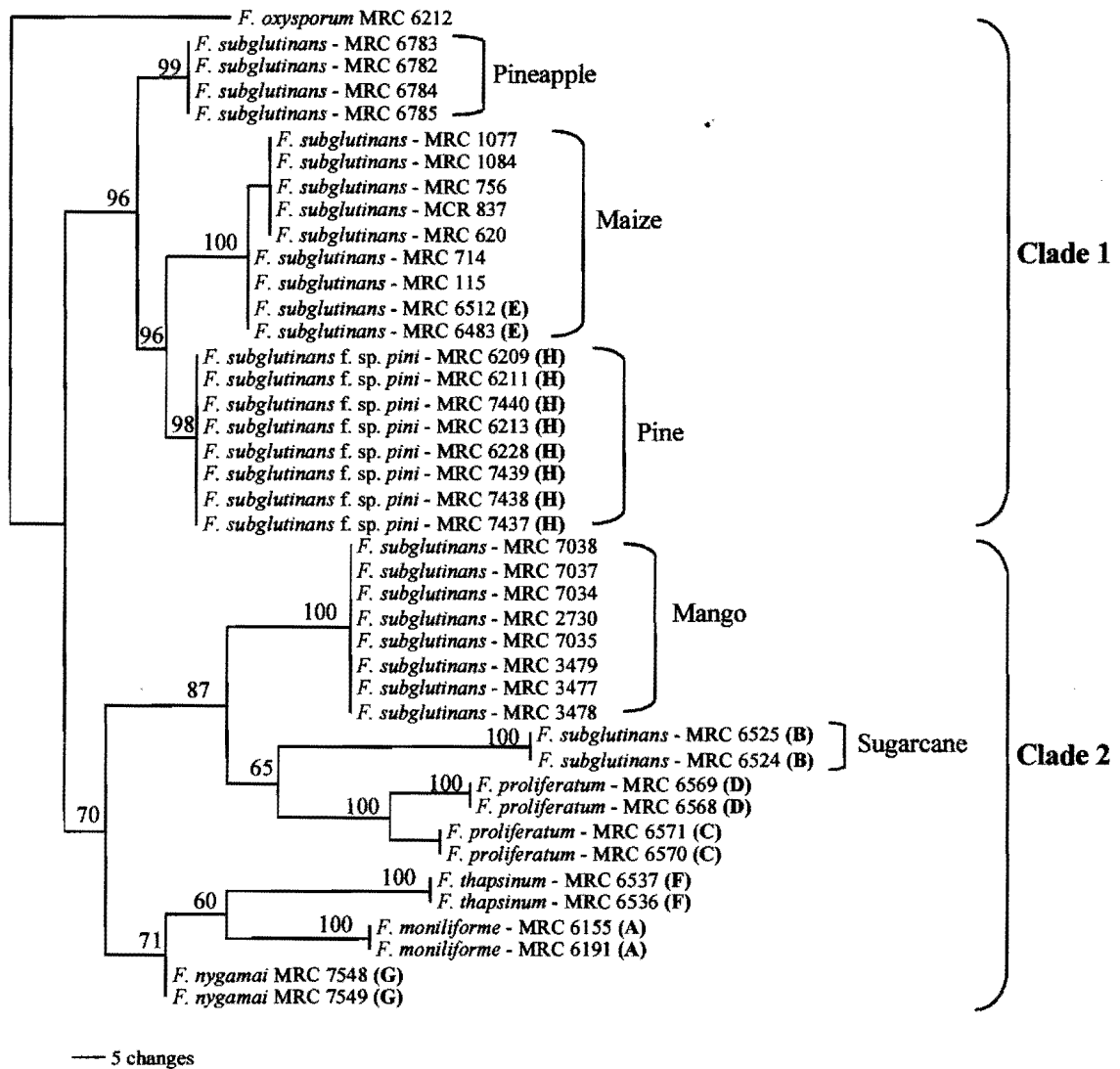

**Figure 1.** Phylogram generated with histone *H3* gene sequence data from the isolates included in this study using PAUP 4.01b. Bootstrap values based on 1,000 replications are indicated as percentages. Bold letters in parentheses refer to the *G. fujikuroi* mating populations. This dendrogram is rooted to the *F. oxysporum* (MRC 6212). The length of the tree was 201 steps, and the values for the homoplasy index and retention index were 0.24 and 0.94, respectively.

**M A B C D E F G H 1 2 3 M**

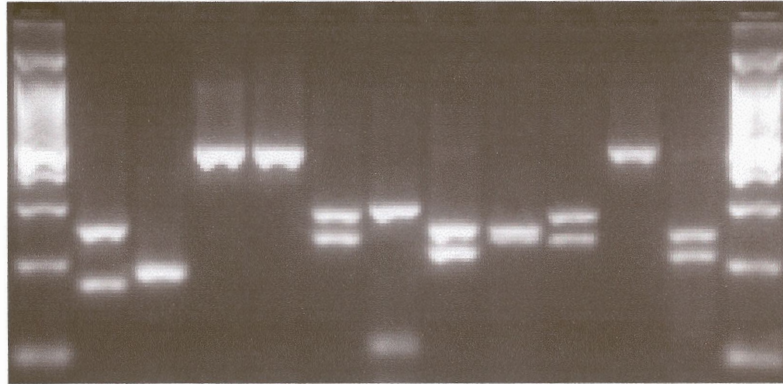

**Figure 2.** PCR-RFLP profiles generated by digesting the *Fusarium* histone *H3* gene amplification products with *Dde*1 and *Cfo*1. Electrophoresis was performed on 3% agarose gels at 3 V/cm. Lane M = 100-bp ladder (1500, 1000, 900, 800, 700, 600, 500, 400, 300, 200, 100 bp); lane A, mating population A; lane B, mating population B (*F. subglutinans* associated with sugarcane); lane C, mating populations C; lane D, mating populations D, lane E, mating population E (*F. subglutinans* associated with maize); lane F, mating population F; lane G, mating population G; lane H, *F. subglutinans* f. sp. *pini* (mating population H); lane 1, *F. subglutinans* from maize; lane 2, *F. subglutinans* from pineapple (*F. subglutinans* f. sp. *ananas*); lane 3 = *F. subglutinans* from mango.



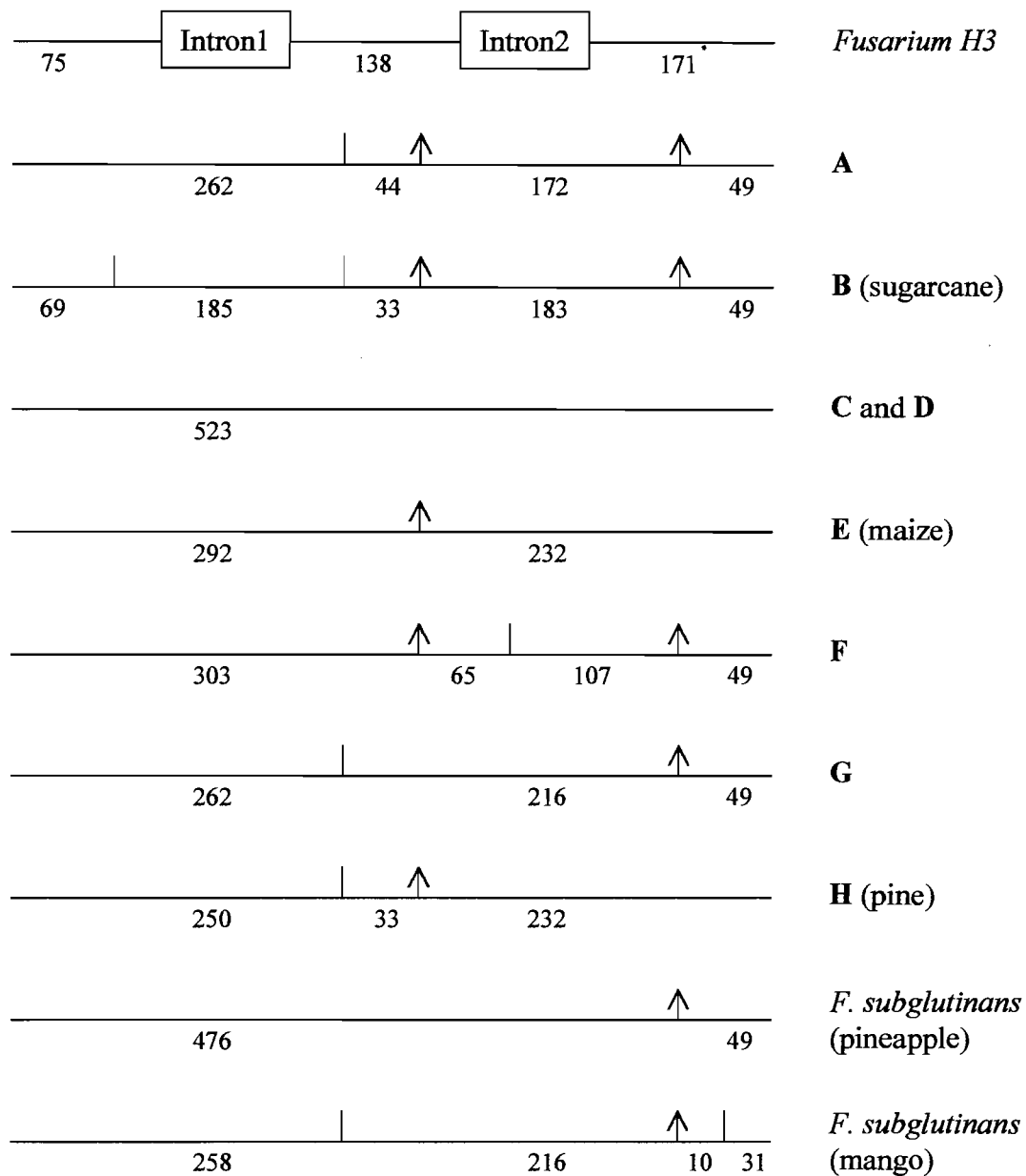

**Figure 3.** Restriction maps of the histone *H3* gene from the different isolates of *Fusarium*, generated with the restriction enzymes *Dde1* and *Cfo1*. The *Fusarium* introns are indicated as boxes and the exons are indicated as lines. Bold letters refer to the *G. fujikuroi* mating populations. An arrow indicates a *Cfo1* restriction site and a vertical line indicates a *Dde1* restriction site. Exon and all fragment sizes are indicated as base pairs.



# CHAPTER 3

## PCR-BASED IDENTIFICATION OF *MAT-1* AND *MAT-2* IN THE *GIBBERELLA FUJIKUROI* SPECIES COMPLEX

E.T. Steenkamp<sup>1</sup>, B.D. Wingfield<sup>1</sup>, T.A. Coutinho<sup>1</sup>,  
K.A. Zeller<sup>2</sup>, M.J. Wingfield<sup>1</sup>, W.F.O. Marasas<sup>3</sup> and  
J.F. Leslie<sup>2</sup>

Tree Pathology Co-operative Programme, Forestry and  
Agricultural Biotechnology Institute (FABI), Departments of  
Genetics, Microbiology and Plant Pathology, University of  
Pretoria, Pretoria, 0002, South Africa<sup>1</sup>;

Department of Plant Pathology, Throckmorton Plant Sciences  
Center, Kansas State University, Manhattan, Kansas 66506-5502<sup>2</sup>;  
PROMEC, Medical Research Council, P.O. Box 19070, Tygerberg  
7505, South Africa<sup>3</sup>.

**Published:** Steenkamp et al. *Applied and Environmental  
Microbiology* (2000) **67**(10), 4378-4382.



## ABSTRACT

All sexually fertile strains of the *Gibberella fujikuroi* species complex are heterothallic. The individual mating types for these strains are conferred by the broadly conserved ascomycete idiomorphs *MAT-1* and *MAT-2*. We sequenced both alleles from all the known mating populations or biological species. From these sequences we developed a multiplex PCR technique to distinguish the *MAT-1* and *MAT-2* idiomorphs. We also tested this technique on representative strains from the eight biological species and 22 species or phylogenetic lineages in the *G. fujikuroi* complex. In most cases, either an ~800 bp fragment from *MAT-2* or a ~200 bp fragment from *MAT-1* is amplified. The amplified fragments cosegregate with mating type, as defined by sexual cross-fertility, in a cross of *Fusarium moniliforme* (= *F. verticillioides*). Neither of the primer pairs amplify fragments from *Fusarium* species such as *F. graminearum*, *F. pseudograminearum*, and *F. culmorum*. These species have, or are expected to have, *Gibberella* sexual stages, but are thought to be relatively distant from the species in the *G. fujikuroi* species complex. Our results further suggest that *MAT* allele sequences are useful indicators of phylogenetic relatedness in these and other *Fusarium* species.

## INTRODUCTION

*Fusarium* isolates in the *Gibberella fujikuroi* species complex include important plant pathogens and may be divided into eight different biological species or mating populations and 32 additional asexual species or phylogenetic lineages (4, 10, 13, 15, 16). All sexually fertile species in the *G. fujikuroi* complex are dimictic, i.e., two isolates are cross-fertile if they carry the different mating type idiomorphs *MAT-1* and *MAT-2* (4, 6, 9, 13). These idiomorphs share no sequence similarity with respect to either DNA sequence or the proteins encoded (5). The *MAT-2* idiomorphs thus far characterized have a conserved HMG (high-mobility-group) domain (3, 5, 6, 19), whereas the *MAT-1* idiomorphs have a conserved  $\alpha$ -domain (5, 25).

Our objectives in this study were (i) to sequence conserved portions of the *MAT-1* and *MAT-2* alleles from the eight known *G. fujikuroi* mating populations, (ii) to develop a multiplex PCR reaction to be used for the identification of both mating type idiomorphs within the defined biological species of the *G. fujikuroi* complex, (iii) to determine the range of *Fusarium* species that have *Gibberella* teleomorphs to which this technique can be successfully applied, and (iv) to test the use of the *MAT* idiomorph sequences for phylogenetic analyses. This technique would ease the identification of strains to be used in crosses to identify new biological species and would also eliminate the need for sexual crosses to score this trait. *MAT* sequences might also provide an additional marker for testing phylogenetic robustness.

## MATERIALS AND METHODS

**Fungal isolates.** We examined the 16 standard mating type testers (4, 10, 13) from the eight described mating populations in the *G. fujikuroi* species complex, 128 progeny from the mapping population described by Xu and Leslie (23), and all of the strains examined by Kérenyi et al. (9). We also used 29 additional species or phylogenetic lineages; names indicated with an \* are invalid (1). These strains were [Species, strain number(s)] as follows: *F. acuminatum* MRC 7681, KSU X-05020, FRC R-6666; *F. acutatum* MRC 7544, KSU X-10679, BBA 69580; *F. annulatum* MRC 2577, KSU X-03831, FRC M-1220, BBA 63629; *F. anthophilum* MRC 2578, KSU X-03818, FRC M-0854, BBA 63270; *F. avenaceum* MRC 7680, KSU X-05017, FRC R-6550; *F. begoniae\**, MRC 7542, KSU X-10767, BBA 67781; *F. beomiforme* MRC 4602, KSU X-05013, FRC M-1088; *F. brevicatenulatum\** MRC 7531, KSU X-10756, BBA 69197; *F. bulbicola* MRC 7534, KSU X-10759, BBA 63628; *F. concentricum\** MRC 7540, KSU X-10765, BBA 64354; *F. crookwellense* MRC 2878, KSU X-04833; *F. culmorum* MRC 7682, KSU X-06576, FRC R-5626; *F. denticulatum\** MRC 7538, KSU X-10763, BBA 67772; *F. dlamini* MRC 3023, KSU X-05009, FRC M-1557; *F. graminearum* (*G. zaeae*) MRC 7677, KSU Z-03639; *F. guttiforme\** MRC 7539, KSU X-10764, BBA 69661; *F. lactis* MRC 7532, KSU X-10757, BBA 68590; *F. napiforme* MRC 3105, KSU X-05015, FRC M-1646; *F. nisikadoi* MRC 7533, KSU X-10758, BBA 69015; *F. oxysporum* f. sp. *cubense* MRC 7671, KSU O-02332; *F. oxysporum* f. sp. *chrysanthemi* MRC 7672, KSU O-02523, FRC O-734; *F. oxysporum* f. sp. *niveum* MRC 7673, KSU O-02529, FRC O-1087; *F. oxysporum* f. sp. *radicis-lycopersici* MRC 7674, KSU O-02530, FRC O-1090; *F. oxysporum* f. sp. *vasinfectum* MRC 7675, KSU O-02533, FRC O-1139; *F. phyllophilum* MRC 2576, KSU X-03829, FRC M-1218, BBA 62262, and MRC 7543, KSU X-10768, BBA 63625; *F. pseudoanthophilum\** MRC 7530, KSU X-10755, BBA 69002; *F. pseudocircinatum\** MRC 7678, KSU X-04379, and MRC 7536, KSU X-10761, BBA 69636; *F. pseudograminearum* (*G. coronicola*) MRC 7670, KSU X-00629, FRC R-5210; *F. pseudonygamai\** MRC 7537, KSU X-10762, BBA 69552; *F. ramigenum\** MRC 7535, KSU X-10760, BBA 68592; *F. solani* MRC 7676, KSU X-03198; *F. subglutinans* (mango) MRC 7679, KSU X-04706; *F. succisae* MRC 2579, KSU X-03832, FRC M-1221 and BBA 63627. Strains were from the Medical Research Council (MRC), Tygerberg, South Africa; Kansas State University (KSU), Manhattan, Kansas; the *Fusarium* Research Center (FRC), The Pennsylvania State University, University Park, Pennsylvania; and the Biologische Bundesanstalt für Land- und Forstwirtschaft (BBA), Berlin, Germany.

**DNA isolation and manipulation.** DNA manipulations and general molecular biology protocols followed those of Sambrook et al. (19). Fungal tissue was harvested from liquid cultures



and ground to a powder in the presence of liquid nitrogen. DNA was isolated as previously described (9, 20), resuspended in deionized water or Tris-EDTA and stored at -20°C.

**PCR amplification of *MAT-2*.** We examined the conserved HMG-domain and 3'-idiomorph flank of *MAT-2*, including the variable sequence between these regions. We used a previously described degenerate primer pair, NcHMG1 and NcHMG2 (3), to amplify the HMG-domain from MRC 6213. This PCR reaction mixture contained 1 ng/μl of DNA, 1 mM deoxynucleoside triphosphates (dNTPs) (0.25 mM of each), 2.5 mM MgCl<sub>2</sub>, 2 μM of each primer, and 0.05 U/μl Super-Therm DNA polymerase and reaction buffer (Southern Cross Biotechnology (Pty) Ltd, Cape Town, South Africa). Reaction mixtures were overlaid with mineral oil to prevent evaporation. The initial denaturation at 92°C for 1 min was followed by 30 cycles of 94°C for 1 min, 60°C for 1 min and 72°C for 1 min. A final extension was performed at 72°C for 10 min. Fragments were resolved and sized on a 2% agarose gel in 0.5 × TBE. A 300 bp fragment was excised from the gel and purified with the QIAquick Gel Extraction Kit (Qiagen GmbH, Hilden, Germany), after which it was cloned into the pCR-Script™ Amp SK (+) vector from Stratagene (Stratagene Cloning Systems, La Jolla, CA). Plasmids were harvested by alkaline lysis and inserts sequenced using M13 forward and reverse primers. Based on this sequence, we designed a *G. fujikuroi*-specific primer for the 5' end of the HMG-domain, GFmat2c (5'-agcgtcattattcgatcaag-3').

To amplify the HMG-domain and a portion of the conserved 3'-idiomorph flank, we performed PCR with the primers, GFmat2c and Fo14. Fo14 (25) is part of the conserved 3'-idiomorph flank from *F. oxysporum* (GenBank Accession number AB011378). PCR conditions were the same as those described for the degenerate PCR, except that 0.2 μM of primers GFmat2c and Fo14 were used. The ~900 bp PCR products from each of the eight *G. fujikuroi* *MAT-2* tester strains were sequenced, and these sequences were used to design a second *G. fujikuroi*-specific *MAT-2* primer GFmat2d (5'-ctacgttgagagctgtacag-3'). GFmat2c and GFmat2d can be used to amplify an ~800 bp fragment that includes part of the conserved HMG-domain and the 3'-idiomorph flank, as well as a variable sequence between these regions. We also analyzed some strains using the GfHMG1 and GfHMG2 primers and PCR amplification conditions of Kerényi et al (9).

**PCR amplification of *MAT-1*.** We used the Falpha1 and Falpha2 degenerate primers (25) to PCR amplify the *MAT-1* α-domain from the eight mating type tester strains that were not *MAT-2*. The ~200 bp PCR products from each were sequenced. Based on these sequences we constructed two specific primers, GFmat1a (5'-gttcatcaaaggcaagcg-3') and GFmat1b (5'-taagcgcctcttaacgccttc-3') that can be used to amplify a ~200 bp portion of the relatively conserved *G. fujikuroi* *MAT-1* α-domain.

**DNA sequencing.** *MAT-1* and *MAT-2* fragments were sequenced in both directions using either primers GFmat2c and Fo14, or primers Falpha1 and Falpha2. PCR products were purified with a QIAquick PCR Purification Kit (Qiagen) and sequenced by using an ABI PRISM™ 377 automated DNA sequencer and an ABI PRISM™ Dye Terminator Cycle Sequencing Ready Reaction Kit (Perkin-Elmer, Warrington, United Kingdom).

We translated DNA sequence and analyzed the inferred amino acid sequence with Sequence Navigator version 1.0.1. (Perkin-Elmer Applied BioSystems, Inc. Foster City, CA). DNA sequences were manually aligned by inserting gaps (see Appendix 2 for aligned sequences), then analyzed with PAUP (Phylogenetic Analysis Using Parsimony) version 4.0\*; Sinauer Associates, Sunderland, Mass. In these analyses gaps were treated as fifth characters (newstate) in heuristic searches, with tree-bisection-reconnection branch swapping. We also performed bootstrap analyses to estimate the confidence of branching points. Trees generated in this way were rooted to *F. oxysporum* *MAT-1* and *MAT-2* sequences (GenBank accession numbers AB011378 and AB011379).

**Diagnostic multiplex PCR for *MAT-1* and *MAT-2*.** The multiplex PCR included the four primers GFmat1a, GFmat1b, GFmat2c, and GFmat2d. We optimized the reaction conditions by varying Mg<sup>2+</sup> concentrations (1.5, 2.0, 2.5, and 3.0 mM), *Taq* polymerase concentration (0.35, 0.40 and 0.45 units per reaction), target DNA concentration (~100 to 20 and ~10 to 2 ng/μl), the annealing temperatures (61, 63, 65 and 67°C), and annealing times (30 or 60 s). After optimization we used the following reaction conditions (10 μl, final volume): 1× PCR buffer (Sigma, St. Louis, MO), 2.5 mM MgCl<sub>2</sub>, 0.2 mM of each dNTP, 0.1 μM of each of the four primers, and 0.4 units of *Taq* DNA polymerase (Sigma). We amplified PCR products according to the following program: an initial denaturation at 94°C for 1 min, followed by 35 cycles of 30 s at 92°C, 30 s at 67°C, and 30 s at 72°C. After the last cycle there was a final elongation step for 5 min at 70°C.

**Blind Test Verification of Diagnostic Multiplex PCR.** We examined 60 strains *G. fujikuroi* mating population H (4), and 102 strains from *G. fujikuroi* mating populations A to F (24). To demonstrate Mendelian segregation and cosegregation of the molecular markers with their corresponding mating phenotype, we examined 128 progeny of a cross between two *F. verticillioides* isolates from the A mating population (23). Prior to these analyses, all isolates were renumbered and the tests were done blind.

## RESULTS

**Analysis of *MAT-2*.** We amplified and sequenced the *MAT-2* HMG-domain, the 3'-idiomorph flank, and the variable sequence flanked by these conserved regions, from a mating type tester representing each of the eight described *G. fujikuroi* mating populations (GenBank accession numbers AF236765 to AF236772). The sequenced portion of the HMG-domain and 3'-idiomorph flank were highly similar (> 92% nucleotide sequence similarity), whereas the variable sequences flanked by these conserved regions were relatively heterogeneous (< 88% sequence similarity). *Neurospora crassa a* (GenBank accession number M54787), *Cochliobolus heterostrophus MAT-2* (GenBank accession number X68398), and *Podospora anserina mat*<sup>+</sup> (GenBank accession number X64195), and all eight *MAT-2* alleles from the *G. fujikuroi* mating type tester have an intron at a conserved position within the HMG-domain (data not shown). Although there were some differences in the sequence (< 90% sequence similarity) of this intron among the *Fusarium* strains, there was no significant similarity (< 30% sequence similarity) to the intron from the other three ascomycetes. The ~800 bp *MAT-2* fragment was amplified from the "+" mating type tester strains from mating populations A, B, D, E and H, and from the "-" mating type tester strains from mating populations C, F and G.

Phylogenetic analysis based on the *MAT-2* sequence data, resulted in a single most parsimonious tree with three distinct clades (Fig. 1). The first clade included the isolates from mating populations A, F, and G; the second clade included the isolates from mating populations B, C, and D; the third clade included isolates from mating populations E and H.

**Analysis of *MAT-1*.** We designed a pair of primers, GFmat1a and GFmat1b, that are specific for the *MAT-1* alleles in *G. fujikuroi*. These alleles shared more than 94% nucleotide sequence similarity in their  $\alpha$ -domains (GenBank accession numbers AF236757 to AF236764). The *G. fujikuroi MAT-1*  $\alpha$ -domain contained an intron at a position similar to the intron in *N. crassa A* (GenBank accession number M33876), *C. heterostrophus MAT-1* (GenBank accession number X68399), and *P. anserina mat* (GenBank accession number 64194). Although there was a significant amount of variation in the *G. fujikuroi*  $\alpha$ -domain intron sequences (> 73% sequence similarity), these sequence shared little similarity (< 40% sequence similarity) with those from the other three ascomycetes. The ~200 bp *MAT-1* fragment was amplified from the "-" mating type tester strains from mating populations A, B, D, E and H, and from the "+" mating type tester strains from mating populations C, F and G.

Phylogenetic analysis of the *MAT-1*  $\alpha$ -domain sequences resulted in a tree with three clades (Fig. 1). The composition of these clades were similar to those obtained from the *MAT-2* sequence

data in that mating populations A, F, and G, mating populations C and D, and mating populations E and H remained grouped. The sequence of the *MAT-1*  $\alpha$ -domain from the B-mating population shared significant similarities with the  $\alpha$ -domains in all the other mating populations, and could be basal to the other seven mating populations (Fig. 1.)

**Diagnostic PCR for *MAT-1* and *MAT-2*.** PCR reactions containing primers GFmat1a, GFmat1b, GFmat2c and GFmat2d, resulted in amplification of either the ~200 bp *MAT-1* or the ~800 bp *MAT-2* fragment (Fig. 2). We obtained better results when either primers GFmat1a and GFmat1b or GFmat2c and GFmat2d, were used as pairs rather than as multiplex reactions. The amount of DNA was an important variable. Results were more reproducible and there was less background with the 1:100 (~2 to 10 ng of DNA/ $\mu$ l) dilutions of initial DNA preparations, than with the 1:10 (~20 to 100 ng of DNA/ $\mu$ l) dilutions. Annealing temperatures also was an important variable. If only the *MAT-1* primers (GFmat1a and GFmat1b) were used, then a single ~200 bp product was detected at all four temperatures tested (61, 63, 65, and 67°C). If only the *MAT-2* primers (GFmat2C and GFmat2d) were used, then clear amplification of a single ~800 bp product was observed only at 65 and 67°C. Increasing the annealing time from 30 to 60 s resulted in more degenerate amplification products.

**Blind tests.** We tested the multiplex PCR amplification on 102 strains from mating populations A-F (24), and 60 strains from mating population H (4) and found that the amplification products detected were the same as those predicted based on the result of sexual crosses. The amplified *MAT* DNA fragments cosegregated with mating type in a genetic mapping cross (9, 24). Thus the amplified fragments map with 95% certainty to a 2.3-map unit region that includes *MAT* and are unlikely to map more than one map-unit from *MAT*, if they are not coincident with it.

***MAT* alleles in other *Fusarium* species and phylogenetic lineages.** We observed no amplification of either *MAT-1* or *MAT-2* fragments from the seven strains from species outside the *Liseola* or *Elegans* sections of the genus. These species were *F. acuminatum*, *F. avenaceum*, *F. crookwellense*, *F. culmorum*, *graminearum*, *F. pseudograminearum*, and *F. solani*. Of the five *F. oxysporum* strains, two were *MAT-1* (KSU O-02523 and O-2529) and three were *MAT-2* (KSU O-02332, O-02530 and O-02533). The *MAT-1* results were clear in the multiplex reaction. No amplification of the *MAT-2* allele was detected in the multiplex reaction, but clear bands were observed from all three strains following PCR amplification using the Kerényi et al. (9) primers. The 23 strains from the *G. fujikuroi* species complex represented 21 species or phylogenetic lineages other than the eight identified *G. fujikuroi* mating populations. We tested two isolates for each of *F. phyllophilum* and *F. pseudocircinatum*. Both *F. phyllophilum* isolates were *MAT-1*, while one *F. pseudocircinatum* isolate (KSU X-04379) was *MAT-1* and the other (KSU X-10761)

was *MAT-2*. Of the remaining 19 species, 9 were represented by a strain from which the *MAT-1* fragment could be amplified. They included *F. annulatum*, *F. anthophilum*, *F. begoniae*, *F. bulbicola*, *F. concentricum*, *F. lactis*, *F. napiforme*, *F. ramigenum*, and *F. succisae*. The other ten species were represented by a strain from which a *MAT-2* fragment could be amplified. These included *F. acutatum*, *F. beomiforme*, *F. brevicatenulatum*, *F. denticulatum*, *F. dlamini*, *F. guttiforme*, *F. nisikidoi*, *F. pseudoanthophilum*, *F. pseudonygamai*, *F. subglutinans* (mango). Representatives from all ten species also yielded a fragment when the Kerényi et al. (9) primers were used.



## DISCUSSION

Kerényi et al. (9) described a primer pair that could be used to prime a PCR reaction that amplified the *MAT-2* idiomorph and they standardized the terminology for mating type in *G. fujikuroi* mating populations A to G. Covert et al. (6) identified a *MAT-2* allele in mating population H and adopted the Kerényi et al. (9) terminology. In this report we extend their results by developing primers for the  $\alpha$ -box of the *MAT-1* idiomorph and by identifying limits on the diversity of species in which the primers will function. We developed a multiplex PCR reaction in which both *MAT-1* and *MAT-2* can be diagnosed as the positive outcome of a PCR amplification reaction without the worry that a lack of amplification, as with the Kerényi et al. (11) or Covert et al. (6) protocols, might have more than one meaning, i.e., no *MAT* sequence to amplify or *MAT-1* allele present.

We examined both of the strains from the B-mating population (MRC 6524 and MRC 6525) that Britz et al. (4) identified as, at least occasionally, homothallic. Both of these strains clearly yielded only a single product in the multiplex PCR amplification reaction. The strain MRC 6524 is *MAT-2* and strain MRC 6525 is *MAT-1*. Thus, the basis for homothallism in these strains cannot be due to mating type switching, as has been observed in some yeasts and a few filamentous fungi (7, 8, 21).

The fragment amplified by our *MAT-2* primers is larger than that of Kerényi et al. (9), ~800 bp and ~260 bp, respectively, and includes a ~560 bp region that is not a part of the conserved HMG-box. Because of the size of the *MAT-2* fragment generated with the Kerényi et al. (9) primers, it is not possible to use them in the multiplex reaction with our *MAT-1* primers. This is because the fragment sizes are similar enough to be difficult to distinguish easily on an agarose gel. Additionally, the annealing temperatures (61 and 67°C, respectively) for the Kerényi et al. (9) *MAT-2* primers and our *MAT-1* primers differ significantly. Nevertheless, the Kerényi et al. (9) primers and our primers do not differ significantly in their ability to amplify fragments from the eight identified mating populations of *G. fujikuroi*, but they do differ in their abilities to prime PCR reactions with DNA from strains of more distantly related species. For example, the Kerényi et al. (9) primers can be used to amplify a fragment from strains of *F. beomiforme* and *F. nisikadoi*. These two species are not closely related to the other species in the *G. fujikuroi* complex based on sequences from the 28S ribosomal DNA, the mitochondrial small subunit ribosomal DNA, and  $\beta$ -tubulin (17).

The conserved nature of the *MAT* alleles has led some to suggest their possible use in phylogenetic and taxonomic studies (21). The phylogenetic trees generated from the partial sequences of both *MAT-1* and *MAT-2* (Fig. 1) are similar to those of O'Donnell et al. (17) and

Steenkamp et al. (20, Chapter 2 of this thesis), with the exception of the placement of mating population B. The B-mating population groups with the isolates from the C- and D-mating populations based on *MAT-2* (Fig. 1), histone (21), and  $\beta$ -tubulin (17) DNA sequences. The partial *MAT-1* sequences, however, suggest that mating population B is approximately equally distant from the seven other mating populations (Fig. 1). Thus, the B-mating population  $\alpha$ -domain could have resulted from a hybridization event between the  $\alpha$ -domains of strains from the other mating populations, or it could be the basal progenitor of the  $\alpha$ -domain in the other mating populations. To resolve this problem, a larger, and perhaps more variable, portion of the *MAT-1* idiomorph from more strains and species will have to be sequenced and analyzed.

Molecular scoring of mating type will reduce the amount of effort required to screen field populations for sexual fertility. Molecular screening should also increase the efficiency of the process through which new mating populations are identified. Diagnosis of the mating type of strains assigned to a known mating population using the PCR-based technique described here, can reduce the number of crosses needed in two ways. First, only crosses with the tester of the opposite mating type need to be made, thereby reducing the number of crosses by one half. Second, if the initial crosses are successful, then the crosses need not be repeated to confirm fertility, since the molecular diagnosis provides this confirmation.

For the identification of a new mating population, each putative member of the new mating population must be used as both a male and a female parent in crosses with all of the other putative members of that mating population to identify female-fertile strains. If a set of 60 strains is used, then 3600 crosses ( $60^2$ ) are needed to test the 60 strains for the presence of female fertility at the 5% frequency level with 95% confidence. If mating type is scored molecularly, then the number of crosses that need to be made is significantly reduced. For example, if a 40:20 split at mating type is detected following PCR amplification, then only 1660 crosses would be needed.

The availability of molecular diagnostics for mating type also may enable the analysis of purportedly asexual fungi, such as *F. oxysporum*, and 12 of the 13 new *Fusarium* taxa (15, 16). There is circumstantial evidence in *F. oxysporum* for sexual reproduction in the form of high levels of diversity with respect to the multi-locus vegetative compatibility trait (see for example refs 8, 11, 12, 22), especially in populations of putatively nonpathogenic strains. Sexual reproduction need not be frequent to still play an important role in the maintenance and generation of genotypic diversity within field populations of these fungi (14), and the availability of mating type data should make it easier to identify potentially cross-fertile strains that can be used to test some of these hypotheses.

In conclusion, we developed a multiplex PCR reaction for scoring mating type within the

existing mating populations of *G. fujikuroi* that will speed the analysis of natural populations of these fungi. Additionally, *MAT-1* and *MAT-2* sequences may be useful in taxonomic and phylogenetic studies of this group of fungi, but sequences from more strains and species will need to be analyzed.

## REFERENCES

1. **Anonymous.** 1999. Index of fungi. *Index fungi*. **6**:979-980.
2. **Appel, D. J., and T. J. Gordon.** 1994. Local and regional variation in populations of *Fusarium oxysporum* from agricultural field soils. *Phytopathology*. **84**:786-791.
3. **Arie, T., S. K. Christiansen, O. C. Yoder, and B. G. Turgeon.** 1997. Efficient cloning of ascomycete mating type genes by PCR amplification of the conserved *MAT* HMG box. *Fungal Genet. Biol.* **21**:118-130.
4. **Britz, H., T. A. Coutinho, M. J. Wingfield, W. F. O. Marasas, T. J. Gordon, and J. F. Leslie.** 1999. *Fusarium subglutinans* f. sp. *pini* represents a distinct mating population in the *Gibberella fujikuroi* species complex. *Appl. Environ. Microbiol.* **65**:1198-1201.
5. **Coppin, E., R. Debuchy, S. Arnaise, and M. Picard.** 1997. Mating types and sexual development in filamentous ascomycetes. *Microbiol. Mol. Biol. Rev.* **61**:411-428.
6. **Covert, S. F., A. Briley, M. M. Wallace, and V. T. McKinney.** 1999. Partial *MAT-2* gene structure and the influence of temperature on mating success in *Gibberella circinata*. *Fungal Genet. Biol.* **28**:43-54.
7. **Gutz, H., and H. Schmidt.** 1990. The genetic basis of homothallism and heterothallism in *Saccharomyces cerevisiae* and *Schizosaccharomyces pombe*. *Sem. Develop. Biol.* **1**:169-176.
8. **Herskowitz, I.** 1988. Life cycle of the budding yeast *Saccharomyces cerevisiae*. *Microbiol. Rev.* **52**:536-553.
9. **Kerényi, Z., K. A. Zeller, L. Hornok, and J. F. Leslie.** 1999. Molecular standardization of mating type terminology in the *Gibberella fujikuroi* species complex. *Appl. Environ. Microbiol.* **65**:4071-4076.
10. **Klaasen, J. A., and P. E. Nelson.** 1996. Identification of a mating population, *Gibberella nygamai* sp. nov., within the *Fusarium nygamai* anamorph. *Mycologia*. **88**:965-969.
11. **Kondo, N., F. Kodama, and A. Ogoshi.** 1997. Vegetative compatibility groups of *Fusarium oxysporum* f. sp. *adzukicola* and nonpathogenic *Fusarium oxysporum* on adzuki bean isolated from adzuki bean fields in Hokkaido. *Ann. Phytopathol. Soc. Jpn.* **63**:8-12.
12. **Leslie, J. F.** 1993. Fungal vegetative compatibility. *Annu. Rev. Phytopathol.* **31**:127-150.
13. **Leslie, J. F.** 1995. *Gibberella fujikuroi*: Available populations and variable traits. *Can. J. Bot.* **73**:S282-S291.
14. **Leslie, J. F., and K. K. Klein.** 1996. Female fertility and mating type effects on effective population size and evolution in filamentous fungi. *Genetics*. **144**:557-567.
15. **Nirenberg, H. I., and K. O'Donnell.** 1998. New *Fusarium* species and combinations within the *Gibberella fujikuroi* species complex. *Mycologia*. **90**:434-458.



16. **Nirenberg, H. I., K. O'Donnell, J. Kroschel, A. P. Andrianaivo, J. M. Frank, and W. Mubatanhema.** 1998. Two new species of *Fusarium*: *Fusarium brevicatenulatum* from the noxious weed *Striga asiatica* in Madagascar and *Fusarium pseudoanthophilum* from *Zea mays* in Zimbabwe. *Mycologia*. **90**:459-464.
17. **O'Donnell, K., E. Cigelnik, and H. I. Nirenberg.** 1998. Molecular systematics and phylogeography of the *Gibberella fujikuroi* species complex. *Mycologia*. **90**:465-493.
18. **Perkins, D. D.** 1987. Mating-type switching in filamentous Ascomycetes. *Genetics*. **115**:215-216.
19. **Sambrook, J. E., F. Fritsch, and T. Maniatis.** 1989. *Molecular cloning: A laboratory manual*, 2<sup>nd</sup> ed. Cold Spring Harbor Laboratory Press, Cold Spring Harbor.
20. **Steenkamp, E. T., B. D. Wingfield, T. A. Coutinho, M. J. Wingfield, and W. F. O. Marasas.** 1999. Differentiation of *Fusarium subglutinans* f. sp. *pini* by histone gene sequence data. *Appl. Environ. Microbiol.* **65**:3401-3406.
21. **Turgeon, B. G.** 1998. Application of mating type gene technology to problems in fungal biology. *Annu. Rev. Phytopathol.* **36**:115-137.
22. **Woudt, L. P., A. Neuvel, A. Sikkema, M. Q. J. M. van Grinsven, W. A. J. de Milliano, C. L. Campbell, and J. F. Leslie.** 1995. Genetic variation in *Fusarium oxysporum* from cyclamen. *Phytopathology*. **85**:1348-1355.
23. **Xu, J.-R., and J. F. Leslie.** 1996. A genetic map of *Fusarium moniliforme* (*Gibberella fujikuroi* mating population A). *Genetics* **143**:175-189.
24. **Yan, K., M. B. Dickman, J.-R. Xu, and J. F. Leslie.** 1993. Sensitivity of field strains of *Gibberella fujikuroi* (*Fusarium* section *Liseola*) to benomyl and hygromycin B. *Mycologia*. **85**:206-213.
25. **Yoshida, T. T. Arie, Y. Nomura, O. C. Yoder, B. G. Turgeon, and I. Yamaguchi.** 1998. Cloning mating type genes of the asexual ascomycete *Fusarium oxysporum*. *Proc. VIIth Internat. Cong. Plant Pathol. (Edinburgh, Scotland)*, p. 1.10.7.

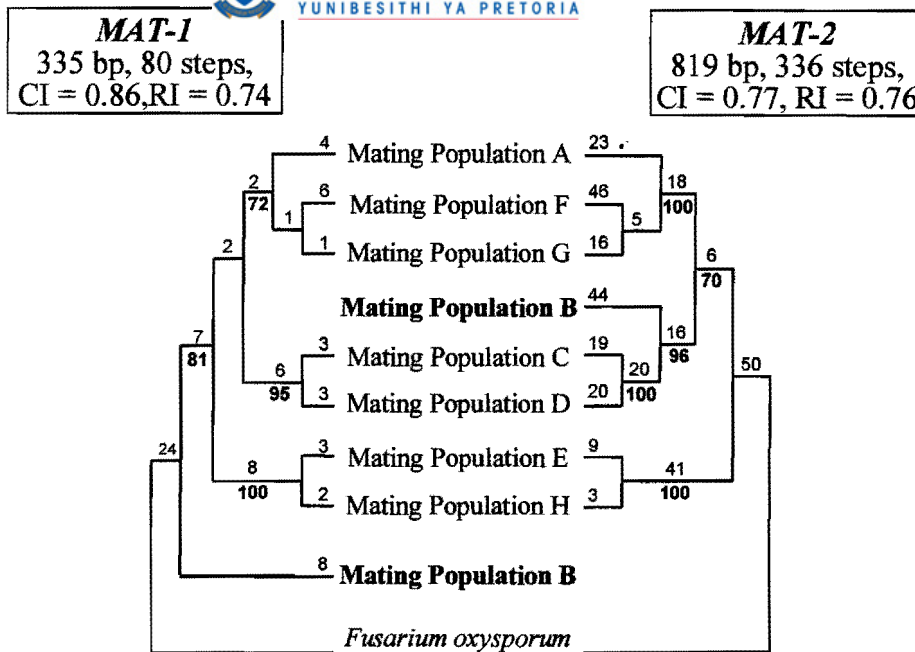

**Figure 1.** Phylograms generated from partial *MAT-1* (left) and *MAT-2* DNA sequence data for the eight identified mating populations (A to H) in the *G. fujikuroi* species complex. The trees were generated with PAUP and rooted to *F. oxysporum*. Bootstrap values are based on 1,000 replications and are indicated as percentages in bold below the branches. Branch lengths are indicated above the branches.

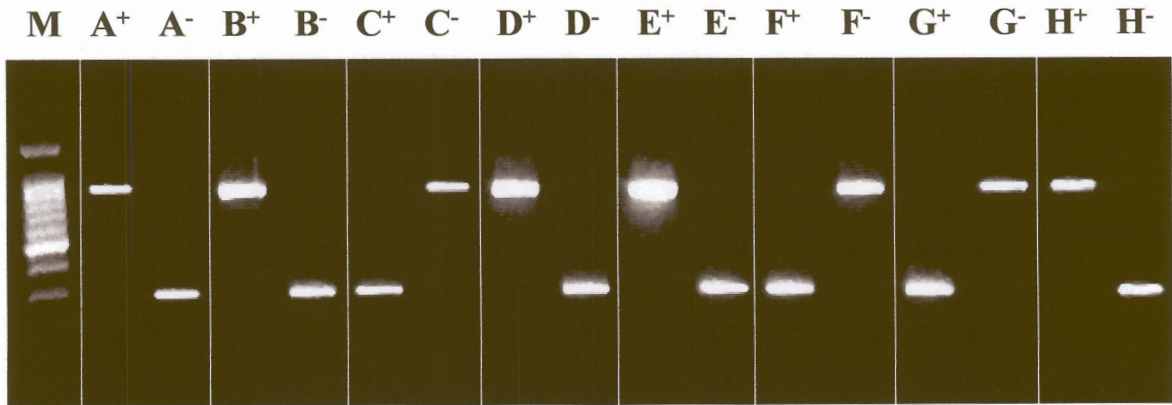

**Figure 2.** PCR amplification of the *MAT* region using the multiplex PCR described in this study. The ~800 bp fragment are amplified from the *MAT-2* regions of the *Gibberella fujikuroi* mating populations A to H, whereas the ~200 bp fragments are amplified from their *MAT-1* regions. Lane M, 100-bp ladder (1500, 1000, 900, 800, 700, 600, 500, 400, 300, 200, 100 bp); lanes A<sup>+</sup>, B<sup>+</sup>, C<sup>-</sup>, D<sup>+</sup>, E<sup>+</sup>, F<sup>-</sup>, G<sup>-</sup> and H<sup>+</sup>, *MAT-2* tester strains; lanes A<sup>-</sup>, B<sup>-</sup>, C<sup>+</sup>, D<sup>-</sup>, E<sup>-</sup>, F<sup>+</sup>, G<sup>+</sup> and H<sup>-</sup>, *MAT-1* tester strains.



# CHAPTER 4

## MOLECULAR CHARACTERIZATION OF *FUSARIUM SUBGLUTINANS* ASSOCIATED WITH MANGO MALFORMATION

E.T. Steenkamp<sup>1</sup>, H. Britz<sup>1</sup>, T.A. Coutinho<sup>1</sup>, B.D. Wingfield<sup>1</sup>, M.J. Wingfield<sup>1</sup> and W.F.O. Marasas<sup>2</sup>

Tree Pathology Co-operative Programme, Forestry and  
Agricultural Biotechnology Institute (FABI), Departments of  
Genetics, Microbiology and Plant Pathology, University of  
Pretoria, Pretoria, 0002, South Africa<sup>1</sup>;  
PROMEC, Medical Research Council, P.O. Box 19070, Tygerberg  
7505, South Africa<sup>2</sup>.

**Published:** Steenkamp et al. *Molecular Plant Pathology*  
(2000) 1(3), 187-193.



## ABSTRACT

Mango malformation is a serious disease of *Mangifera indica* in tropical and subtropical regions of the world. This disease is caused by *Fusarium subglutinans*, which is also associated with diseases on many other hosts, such as pineapple, pine, maize and sugarcane. The *F. subglutinans* strains associated with different hosts are virtually indistinguishable using morphological characters, but can be easily differentiated using histone and  $\beta$ -tubulin gene sequencing, and some have subsequently been assigned to distinct species. The aim of this study was to characterize *F. subglutinans* isolates associated with mango malformation using histone *H3* gene sequencing and to compare them with other isolates in the *G. fujikuroi* complex. Analysis of histone sequence data revealed the presence of two phylogenetically distinct groups of *F. subglutinans* isolates associated with mango malformation. We also considered the identity of the two groups of isolates associated with mango malformation and determined their relatedness to other *Fusarium* spp. For this purpose, portions of the  $\beta$ -tubulin gene were sequenced and compared with the  $\beta$ -tubulin sequences deposited in the National Center for Biotechnology Information (NCBI) nucleotide database. This comparison to the NCBI database indicated that the one group of *F. subglutinans* strains isolated from mango constitutes a unique lineage in the *G. fujikuroi* complex. Based on  $\beta$ -tubulin and histone *H3* sequencing, the second group of isolates is conspecific with the *F. subglutinans* strains previously reported to be the causal agent of mango malformation.



## INTRODUCTION

Mango (*Mangifera indica* L.) is a fruit tree grown commercially in many tropical and subtropical areas of the world (10, 20). The mango industries of many countries are threatened by the fungal disease known as mango malformation (10). The most prominent symptom of this disease is the deformation of flowers (10). This floral malformation is characterized by thick, fleshy and profusely branched panicles that are crowded by enlarged flowers (10). These malformed panicles generally do not bear fruit, because they remain very small or are aborted prematurely (10, 26). The second important symptom of this disease is the deformation of mature trees (10). Nursery seedlings can also be infected, which leads to the spread of mango malformation to new areas (10, 20).

*Fusarium subglutinans* (Wollew. & Reinking) Nelson, Toussoun & Marasas is recognized as the causal agent of mango malformation and has been consistently isolated from diseased mango tissue (3, 4, 12, 13, 24, 26, 27). This species forms part of the *Gibberella fujikuroi* (Sawada) Wollenw. complex and is associated with at least three biological species or mating populations (B, E and H) and many different hosts, such as pine, maize, sugarcane and pineapple (1, 6, 9, 11, 21, 28). Although some of these *F. subglutinans* collections have recently been elevated to species level (16, 18), it is difficult and sometimes impossible to distinguish *F. subglutinans* strains associated with different hosts. It is therefore impractical to use only morphological characters to differentiate *F. subglutinans* associated with mango from strains representing the other host-specific groups of this anamorph species.

Leslie (11) showed that *F. subglutinans* isolated from mango and *F. subglutinans* mating population B (= *F. sacchari*) share similar isozyme profiles. Recently, Steenkamp et al. (22, Chapter 2 of this thesis) reported on a PCR-RFLP (polymerase chain reaction-restriction length polymorphisms)-based method to differentiate between the *F. subglutinans* isolates associated with pine, maize, pineapple, sugarcane and mango. Their results and those of O'Donnell et al. (18) indicated that the *F. subglutinans* isolates associated with mango malformation are closely related to, but distinct from *F. subglutinans* mating population B. Both of these DNA-based methods showed that *F. subglutinans* associated with mango malformation cluster with isolates residing in mating populations B, C and D (18, 22, Chapter 2 of this thesis).

In a recent survey of mango malformation in South Africa, *F. subglutinans* was consistently isolated from diseased mango trees. In contrast to the findings of Steenkamp et al. (22, Chapter 2 of this thesis) histone *H3* PCR-RFLPs revealed not one, but two, distinct groups of *F. subglutinans* associated with this disease. Our aim was, therefore, to characterize the existing and new group of *F. subglutinans* isolates from mango using histone *H3* gene sequencing and to compare them with

other *Fusarium* isolates in the *G. fujikuroi* species complex. We also attempted to determine the possible identities of the two groups of *F. subglutinans* isolates associated with mango malformation by sequencing two portions of the  $\beta$ -tubulin gene from selected individuals. These sequences were compared to the previously published sequences in the National Center for Biotechnology Information (NCBI) database.

## MATERIALS AND METHODS

**Fungal isolates.** We examined 18 *F. subglutinans* strains associated with mango malformation in South Africa, United States and Israel (Table 1). The South African strains were isolated by surface sterilizing mango inflorescence clusters with 70% ethanol, after which single infected flowers were removed and placed on *Fusarium* selective media (14). Isolates obtained from this treatment were then morphologically characterized according to Nelson et al. (15). For comparative purposes, we also included isolates of *F. subglutinans* f. sp. *pini* (mating population H; strains MRC 6213 and MRC 7488), *F. subglutinans* mating population B (= *F. sacchari*; MRC 6524 and MRC 6525), *F. subglutinans* mating population E (MRC 6483 and MRC 6512), *F. subglutinans* f. sp. *ananas* (MRC 6782 and MRC 6783). The *G. fujikuroi* mating tester strains for mating populations A (= *F. verticillioides*; strains MRC 6191 and MRC 6155), C (= *F. fujikuroi*; strains MRC 6570 and MRC 6571), D (= *F. proliferatum*; strains MRC 6568 and MRC 6569), F (= *F. thapsinum*; strains MRC 6536 and MRC 6537) and G (= *F. nygamai*; strains MRC 7548 and MRC 7549) were also included. All isolates are available from the Collection of the Programme on Mycotoxins and Experimental Carcinogenesis (PROMEC), Medical Research Council, Tygerberg, South Africa.

**Vegetative compatibility.** *F. subglutinans* isolates associated with mango malformation were examined for vegetative compatibility using nitrate non-utilizing (*nit*) mutants (2).

**DNA isolation.** DNA was isolated using a CTAB (*N*-cetyl-*N,N,N*-trimethyl-ammonium bromide) extraction method (22, Chapter 2 of this thesis).

***H3* gene amplification and sequencing.** The *H3* histone gene from all the isolates from mango was amplified using the primers H3-1a (5'-actaagcagaccgcccgcagg-3') and H3-1b (5'-gcgggcgagctggatgtcctt-3') (5). PCR and cycling conditions were similar to those described previously (22, Chapter 2 of this thesis). After PCR, the products were purified with a QIAquick PCR Purification Kit (Qiagen GmbH, Hilden, Germany) and sequenced in both directions with the primers H3-1a and H3-1b. Reactions were performed on an ABI PRISM™ 377 automated DNA sequencer, with an ABI PRISM™ Dye Terminator Cycle Sequencing Ready Reaction Kit (Perkin Elmer, Warrington, United Kingdom). Sequences were analyzed with Sequence Navigator version 1.0.1.™ (Perkin Elmer Applied BioSystems, Inc., Foster City, CA) and aligned manually by inserting gaps (see Appendix 3 for aligned sequences). Phylogenetic analyses were performed with PAUP (Phylogenetic Analysis Using Parsimony) version 4.0b1 (25). Each gap was treated as a fifth character (newstate) in heuristic searches, with tree-bisection-reconnection branch swapping and MULTREES (saving of all optimal trees) effective. Bootstrap analyses were based on 1,000 replications. The histone *H3* gene sequence for the mating tester strains and *F. subglutinans* f. sp.



*ananas* were obtained from GenBank and were also included in the phylogenetic analysis (GenBank accession numbers AF150833, AF150834, AF150844, AF150845, AF150849, AF150854, AF150855, AF150856, AF150857, AF150858, AF150859, AF150860, AF150861, AF150870, AF150871, AF150872, AF150873, AF150878). *F. oxysporum* (GenBank accession number AF150832) *H3* histone gene sequence was used as an outgroup in the analysis.

**$\beta$ -tubulin gene amplification and sequencing.** The  $\beta$ -tubulin gene was amplified from two *F. subglutinans* isolates (MRC 7877 and MRC 3478) associated with mango malformation, using the primers T1 (5'-aacatgctgagattgtaagt-3') and T22 (5'-tctggatgtgtgggaatcc-3') (17). PCR and cycling conditions were similar to those described by these authors. PCR products were purified and cycle sequenced as described above. The first intron-rich region of the  $\beta$ -tubulin gene was sequenced using the forward primer T1 and the nested reverse primer T21 (5'-ggtttgccagaaagcagcacc-3') (17). The last intron and the adjacent coding  $\beta$ -tubulin regions were sequenced using the nested forward primer T121 (5'-ccacctgtctccgtttcccg-3') and the reverse primer T22 (17).

Sequences were analyzed with Sequence Navigator and then compared against the NCBI nucleotide database using BLAST (<http://www.ncbi.nlm.nih.gov/cgi-bin/BLAST/>). This was done to determine the possible identity of the *F. subglutinans* isolates associated with mango malformation. For the possible candidates, corresponding  $\beta$ -tubulin sequences were obtained from GenBank. The sequences for the *G. fujikuroi* mating populations A to H and *F. subglutinans* f. sp. *ananas* were also obtained from GenBank. These sequences, together with the  $\beta$ -tubulin sequences for isolates MRC 7877 and MRC 3478 were manually aligned (see Appendix 3 for aligned sequences) and subjected to phylogenetic analyses as described above. *F. oxysporum*  $\beta$ -tubulin sequence obtained from GenBank was used as an outgroup in the analyses.

**Sexual compatibility tests and identification of mating types.** The *F. subglutinans* isolates associated with mango malformation included in this study were crossed with the mating tester strains for the *G. fujikuroi* mating populations A to F, and *F. subglutinans* f. sp. *ananas*, as well as with one another in all possible pair wise combinations using previously published techniques (1, 8). Crosses were scored as positives when ascospores exuded from perithecia. Additionally, the mating types of all the *F. subglutinans* isolates associated with mango malformation, were determined using the PCR-based techniques reported by Kerényi et al. (7) and Steenkamp et al. (23).

## RESULTS

**Fungal isolates.** All 18 of the isolates associated with mango malformation included in this study produced abundant microconidia that were formed on polyphialides. These were always in false heads and never in chains, which is a characteristic feature of *F. subglutinans*. Macroconidia were also abundant and straight to slightly sickle-shaped. Chlamydospores were absent, which is another typical feature of *F. subglutinans*.

**Vegetative compatibility.** The *F. subglutinans* strains associated with mango malformation included in this study could be divided into four distinct vegetative compatibility groups (VCGs) (Table 1). The two Israeli isolates were in one VCG (VCG1) and those from the United States were also in a single VCG (VCG2). Three of the South African isolates from the Kwa-Zulu/Natal area (MRC 3477, MRC 3478 and MRC 3479) and one from the Nelspruit area (MRC 2730) were in VCG3. The remaining six South African strains from the Tzaneen area (MRC 2802, MRC 7605, MRC 7873, MRC 7875, MRC 7876 and MRC 7877) were in VCG4.

**H3 gene sequence.** In this study, 455 base pairs (bp) sequences were used to determine the relationships between the *F. subglutinans* strains associated with mango malformation and species of the *G. fujikuroi* complex (see Table 1 for GenBank accession numbers). Phylogenetic analysis using PAUP version 4.0b1 generated two most parsimonious trees that were similar except for the length of some of the minor branches. Both of these dendrograms consisted of three distinct clades, labeled Clade 1, 2 and 3 (Fig. 1). Clade 1 included the *G. fujikuroi* mating populations E and H, as well as *F. subglutinans* f. sp. *ananas* (Fig. 1). This clade also contained six of the South African *F. subglutinans* strains (Table 1) isolated from mango. *F. subglutinans* f. sp. *ananas*, together with the isolates from mango, formed a sister group to the one containing mating populations E and H. Clade 3 included mating populations B, C and D, as well as the 12 remaining *F. subglutinans* isolates (Table 1) associated with mango malformation in South Africa, Israel and United States (Fig. 1). Clade 2 included the *G. fujikuroi* mating populations A, F and G.

**$\beta$ -tubulin gene sequence.** Using the  $\beta$ -tubulin primer sets T1 / T21 and T121 / T22, 337 bp and 466 bp, respectively, of DNA sequence were generated (17). Comparison of these sequences to those in the NCBI database indicated that both  $\beta$ -tubulin portions from the isolate MRC 3478 were 100 % homologous to those of *Fusarium* strain NRRL 25226 (See Fig. 2 for GenBank accession numbers). *Fusarium* strain NRRL 25226 was collected in India from mango (18).

Both of the sequenced portions of the  $\beta$ -tubulin gene from isolate MRC 7877 were 99 % similar to those of four other *Fusarium* strains in the NCBI database (See Fig. 2 for GenBank accession numbers). For the sequence generated with primers T1 and T21, isolate MRC 7877 shared 462 bp out of 466 bp homology with *Fusarium* strains NRRL 25346, NRRL 25807, and *F.*

*succisae* and 460 bp out of 462 bp homology with the strain NRRL 25195. For the sequence generated with the second primer set, isolate MRC 7877 shared 335 bp out of 337 bp homology with the NRRL 25807 strain, 334 bp out of 337 bp with *F. succisae* and the NRRL 25195 strain, and 332 bp out of 335 bp homology with the NRRL 25346 strain. The *Fusarium* strains NRRL 25195, 25807 and 25346 were isolated from wood in Venezuela, *Pennisetum typhoides* in Namibia and *Ipomoea batatas* in Peru, respectively (18).

Phylogenetic analysis using these sequenced portions of the  $\beta$ -tubulin gene showed that the *F. subglutinans* isolate MRC 3478 grouped together with the *Fusarium* strain NRRL 25226 in Clade 3 (Fig. 2). The second *F. subglutinans* isolate from mango, MRC 7877, clustered with mating populations E, H and *F. subglutinans* f. sp. *ananas* in Clade 1 (Fig. 2). The *Fusarium* strains NRRL 25195, 25807 and 25346 and *F. succisae* also reside in this clade.

**Sexual compatibility and identification of mating types.** None of the *F. subglutinans* isolates associated with mango malformation were sexually compatible with any of the *G. fujikuroi* mating population tester strains. These isolates from mango also did not cross with one another. Six of the South African isolates associated with mango malformation were of mating type *MAT-1*, whereas the remaining 12 isolates associated with mango malformation had the *MAT-2* mating type (Table 1).

## DISCUSSION

We analyzed 18 isolates of *F. subglutinans* associated with mango malformation (Table 1) and based on our *H3* sequence data these isolates could be placed in two distinct groups (Fig. 1). The first group included 12 *F. subglutinans* strains isolated from mango in South Africa, United States and Israel (Table 1). Based on DNA sequence data, this group resides in Clade 3, together with the *G. fujikuroi* mating populations B, C and D (Fig. 1). The second group included six *F. subglutinans* strains from South Africa and resides in Clade 1, together with the *G. fujikuroi* mating populations E and H (Table 1, Fig. 1). Mango malformation in South Africa is, therefore, associated with two phylogenetically distinct groups of *F. subglutinans* isolates, which are morphologically indistinguishable, but that occupy the same ecological niche.

In the Kwa-Zulu/Natal area of South Africa, only *F. subglutinans* strains belonging to Clade 3 were isolated. An additional strain belonging to this clade was also collected from the Nelspruit area. All of these isolates were, however, from a single vegetative compatibility group, VCG3 (Table 1). In the Tzaneen area, only *F. subglutinans* strains belonging to Clade 1 were isolated. Similar to the isolates included in Clade 3, all the isolates from Clade 1 also belonged to a single VCG, VCG4 (Table 1). This study does not attempt to address any issues regarding the population structure of these two groups of fungi, since too few individuals were available. Our results do, however, suggest that the *F. subglutinans* strains associated with mango malformation in Clades 1 and 3 are clonal. The mating type data for the different South African strains isolated from malformed mango flowers (Table 1) further suggest that the isolates in found in Clades 1 and 3 are clonal.

The position of the set of *F. subglutinans* isolates associated with mango malformation in Clade 2 (Fig. 1), suggests that this group of isolates is equivalent to the single *Fusarium* isolate (NRRL 25226) included by O'Donnell et al. (18). This strain, isolated from mango in India, was further found to be conspecific with the *F. subglutinans* strain MRC 7559, which has previously been shown to be a causal agent of mango malformation (4). Comparison of the sequenced portion of the  $\beta$ -tubulin gene from the South African isolate MRC 3478 with sequence in the NCBI nucleotide database, indicated that this isolate is also conspecific with the Indian isolate (NRRL 25226) studied by O'Donnell et al. (18) (Fig. 2). The fact that the  $\beta$ -tubulin sequence for the *F. subglutinans* strain MRC 3478 and *Fusarium* strain NRRL 25226 was identical to that of MRC 7559, suggests strongly that this group of isolates found in Clade 3 (Fig. 1 and 2), is responsible for causing mango malformation.

The second group of isolates associated with mango malformation in South Africa, residing Clade 1 (Fig. 1), is distinct from all the *G. fujikuroi* mating populations, but most closely related to



*F. subglutinans* f. sp. *ananas*, based on histone gene sequencing. When compared with *F. subglutinans* f. sp. *ananas*, this group of isolates, however, has several differences in its histone gene sequence and appears to represent a discrete taxon. Comparison of the  $\beta$ -tubulin sequence for isolate MRC 7877 with sequence in the NCBI database showed 99 % similarity to several *Fusarium* strains. The sequence for the *F. subglutinans* isolate MRC 7877, however, differed by 5 - 7 bp from *F. succisae* and the *Fusarium* strains NRRL 25195, 25807 and 25346, which were all isolated from hosts other than mango. Based on histone and  $\beta$ -tubulin DNA sequence, this group of *F. subglutinans* isolates constitutes a distinct lineage within the *G. fujikuroi* species complex (Fig. 2). This lineage is consistently associated with mango malformation, but it remains to be shown via pathogenicity tests whether these isolates are able to cause mango malformation.

In South Africa, malformation of mango flowers is associated with *F. subglutinans* strains from the phylogenetic Clades 1 and 3. Interestingly, Clades 1 and 3 correspond to what O'Donnell et al. (18) refer to as the 'American' and 'Asian' clades, respectively. These designation were based on the geographical origins and hosts of the species included in their study. It is therefor reasonable to expect a species from the so-called 'Asian' clade (Clade 3) to occur on mango, since the tree is native to India. The fact that a fungus from the so-called 'American' clade (Clade 1) was collected in Africa and occurs on an Asian host is less consistent with the terminology based on geographical regions. It is possible that an American species could have been introduced into Africa and has now established a niche on an Asian host. However, the assignment of *Fusarium* spp. in *Fusarium* subgroups linked to geographical regions should not be viewed as absolute (18), and the hypothesis that groups of species have discreet geographical origins needs further study.

The results of this study are congruent with those of Steenkamp et al. (22, Chapter 2 of this thesis) and Leslie (11), which also showed that the *F. subglutinans* strains associated with mango in Clade 3 are closely related to mating population B. It was also reported that the isolates used in these studies were not cross-fertile with one another or any of the mating tester strains for the mating populations in the *G. fujikuroi* complex (11). Leslie (11) concluded that these isolates either constitute a new mating population, or that they are sterile members of the B-mating population. Our results show that the first hypothesis is at least partially correct, since the *Fusarium* isolates causing disease on mango are closely related to, but distinctly different from mating population B (Figs. 1 and 2).

In this study we set out to test the hypothesis that the isolates associated with mango constitute a new mating population, using sexual compatibility studies. None of the strains isolated from mango were, however, cross-fertile. This is partially explained by the fact that the isolates from Clades 1 and 3 are phylogenetically distinct and represent separate species (Fig. 1). The fact that isolates from one clade were sexually incompatible with other isolates from the same clade,

could only be explained after examining the mating types of the isolates studied. All of the isolates from mango in the Clade 3 have one mating type, whereas isolates from Clade 1 have the opposite mating type (Table 1). All isolates were thus incapable of sexual reproduction, since individuals of opposite mating type and from the same phylogenetic group or species, were never sampled in this study.

The presence of only one mating type in both Clades 1 and 3, has important implications regarding the taxonomy of the two groups of *F. subglutinans* isolates associated with mango malformation. Species descriptions in the *G. fujikuroi* complex rely on the production of teleomorphs (15, 16). It is, however, currently impossible to produce teleomorphs for the isolates associated with mango malformation. The possibility that isolates with the opposite mating type exist cannot be excluded, but until such time as these are found, anamorph species will need to be described. The fact that one of these anamorphic groups of *F. subglutinans* associated with mango is known to be the causal agent of disease on an economically important crop, necessitates description of at least the latter taxon. These descriptions must, however, be combined with thorough characterization of these groups of fungi and populations in terms of morphology and pathogenicity.

## REFERENCES

1. Britz, H., T. A. Coutinho, M. J. Wingfield, W. F. O. Marasas, T. R. Gordon, and J. F. Leslie. 1999. *Fusarium subglutinans* f. sp. *pini* represents a distinct mating population in the *Gibberella fujikuroi* species complex. *Appl. Environ. Microbiol.* **65**:1198-1201.
2. Correll, J. C., C. J. R. Klittich, and J. F. Leslie. 1987. Nitrate non-utilizing mutants of *Fusarium oxysporum* and their use in vegetative compatibility tests. *Phytopathology.* **77**:1640-1646.
3. Fletchman, C. H. W., H. Kimati, J. C. Madcalf, and J. Ferrer. 1970. Preliminary observations on mango inflorescence malformation and the fungus, insects and mites, associated with it. *Anais de E.S.A. "Luis de Queiroz".* **27**:281-285.
4. Freeman, S., M. Maimon, and Y. Pinkas. 1999. Use of GUS transformants of *Fusarium subglutinans* for determining etiology of mango malformation disease. *Phytopathology.* **89**:456-461.
5. Glass, N. L., and G. C. Donaldson. 1995. Development of primer sets for use in PCR to amplify conserved genes from filamentous ascomycetes. *Appl. Environ. Microbiol.* **61**:1323-1330.
6. Hsieh, W. H., S. N. Smith, and W. C. Snyder. 1977. Mating groups in *Fusarium moniliforme*. *Phytopathology.* **67**:1041-1043.
7. Kerényi, Z., K. Zeller, L. Hornok, and J. F. L. Leslie. 1999. Molecular standardization of mating type terminology in the *Gibberella fujikuroi* species complex. *Appl. Environ. Microbiol.* **65**:4071-4076.
8. Klittich, C. J. R., and J. F. Leslie. 1988. Nitrate reduction mutants of *Fusarium moniliforme* (*Gibberella fujikuroi*). *Genetics.* **118**:417-423.
9. Kuhlman, E. G. 1982. Varieties of *Gibberella fujikuroi* with anamorphs in *Fusarium* section *Liseola*. *Mycologia.* **74**:756-768.
10. Kumar, J., U. S. Singh, and S. P. S. Beniwal. 1993. Mango malformation: One hundred years of research. *Annu. Rev. Phytopathol.* **31**:217-232.
11. Leslie, J. F. 1995. *Gibberella fujikuroi*: Available populations and variable traits. *Can. J. Bot.* **73**:S282-S291.
12. Malo, S. E., and R. T. McMillan. 1972. A disease of *Mangifera indica* L. in Florida similar to mango malformation. *Proc. Fla. State Hortic. Soc.* **85**:264-268.
13. Manicom, B. Q. 1989. Blossom malformation of mango. *S. Afr. Mango Grower's Assoc. Yearb.* **10**:11-12.
14. Nash, S. M., and W. C. Snyder. 1965. Quantitative and qualitative comparisons of

- Fusarium* populations in cultivated fields and non-cultivated parent soils. *Can. J. Bot.* **43**:939-945.
15. Nelson, P. E., T. A. Toussoun, and W. F. O. Marasas. 1983. *Fusarium* species: an illustrated manual of identification. Pennsylvania State University Press, University Park.
  16. Nirenberg, H. I., and K. O'Donnell. 1998. New *Fusarium* species and combinations within the *Gibberella fujikuroi* species complex. *Mycologia.* **90**:434-458.
  17. O'Donnell, K., and E. Cigelnik. 1997. Two divergent intragenomic rDNA ITS2 types within a monophyletic lineage of the fungus *Fusarium* are nonorthologous. *Mol. Phylogenet. Evol.* **7**:103-116.
  18. O'Donnell, K., E. Cigelnik, and H. I. Nirenberg. 1998. Molecular systematics and phylogeography of the *Gibberella fujikuroi* species complex. *Mycologia.* **90**:465-493.
  19. Ploetz, R. C. 1994. Distribution and prevalence of *Fusarium subglutinans* in mango trees affected by malformation. *Can. J. Bot.* **72**:7-9.
  20. Ploetz, R. C. 1994. Part III. Mango. In R. C. Ploetz, G. A. Zentmyer, W. T. Nishijima, K. G. Rohrbach, and H. D. Ohr (ed.), *Compendium of tropical fruit diseases*. American Pathological Society, St. Paul, MN.
  21. Rohrbach, K. G., and J. B. Pfeiffer. 1976. Susceptibility of pineapple cultivars to fruit disease incited by *Penicillium funiculosum* and *Fusarium moniliforme*. *Phytopathology.* **66**:1386-1390.
  22. Steenkamp, E. T., B. D. Wingfield, T. A. Coutinho, M. J. Wingfield, and W. F. O. Marasas. 1999. Differentiation of *Fusarium subglutinans* f. sp. *pini* by histone gene sequence data. *Appl. Environ. Microbiol.* **65**:3401-3406.
  23. Steenkamp, E. T., B. D. Wingfield, T. A. Coutinho, M. J. Wingfield, W. F. O. Marasas, and J. F. Leslie. 1999. PCR-based differentiation of *MAT-1* and *MAT-2* isolates from *Gibberella fujikuroi* mating population H. *Phytopathology.* **89**:S75.
  24. Summanwar, A. S., S. P. Raychoudhuri, and S. C. Pathak. 1966. Association of the fungus *Fusarium* sp. Sheld. with malformation in mango. *Ind. Phytopathol.* **19**:227-228.
  25. Swofford, D. L. 1998. PAUP\*. Phylogenetic Analysis Using Parsimony (\*and Other Methods). Version 4.0\*. Sinauer Associates, Sunderland, Massachusetts.
  26. Varma, A., V. C. Lele, S. P. Raychaudhuri, A. Ram, and A. Sang. 1974. Mango malformation: a fungal disease. *Phytopath. Z.* **79**:254-257.
  27. Varma, A. U., S. P. Raychoudhuri, V. C. Lele, and A. Ram. 1972. Towards the understanding of the problem mango malformation of mango (*Mangifera indica* L.). *Proc. Ind. Natl. Sci. Acad.* **37**:291-300.
  28. Ventura, J. A., L. Zambolim, and R. L. Gilbertson. 1993. Pathogenicity of *Fusarium*





*subglutinans* to pineapples. Fitopatol. Bras. Supl. **18**:280.

**Table 1.** Isolate information, source, vegetative compatibility group (VCG) and mating type of the *Fusarium subglutinans* strains associated with mango malformation used in this study.

Isolates <sup>1</sup>	Origin <sup>2</sup> , orchard, cultivar <sup>3</sup> and date of isolation	Source	VCG <sup>4</sup>	Mating Type <sup>5</sup>	GenBank accession no.
MRC 7559	Israel, Volcani, N/A, 1993	S. Freeman	VCG1	<i>MAT-2</i>	AF236779
MRC 7560	Israel, Ginosar, Kent, 1998	S. Freeman	VCG1	<i>MAT-2</i>	AF236780
MRC 7561	Israel, Sde Nitzan, Tomy, 1998	S. Freeman	N/D	<i>MAT-2</i>	AF236781
MRC 7562	Israel, Bene Dror, Keitt, 1998	S. Freeman	N/D	<i>MAT-2</i>	AF236782
MRC 7034	United States (19)	W. F. O. Marasas	VCG2	<i>MAT-2</i>	AF150864
MRC 7035	United States (19)	W. F. O. Marasas	VCG2	<i>MAT-2</i>	AF150866
MRC 7037	United States (19)	W. F. O. Marasas	VCG2	<i>MAT-2</i>	AF150863
MRC 7038	United States (19)	W. F. O. Marasas	VCG2	<i>MAT-2</i>	AF150862
MRC 2730	South Africa, Nelspruit, N/A, 1982	F. Wehner	VCG3	<i>MAT-2</i>	AF150865
MRC 3477	South Africa, Kwa-Zulu/Natal, N/A, 1984	C. Crookes	VCG3	<i>MAT-2</i>	AF150868
MRC 3478	South Africa, Kwa-Zulu/Natal, N/A, 1984	C. Crookes	VCG3	<i>MAT-2</i>	AF150869
MRC 3479	South Africa, Kwa-Zulu/Natal, N/A, 1984	C. Crookes	VCG3	<i>MAT-2</i>	AF150867
MRC 2802	South Africa, Tzaneen, N/A, 1982	J. Darvas	VCG4	<i>MAT-1</i>	AF236778
MRC 7605	South Africa, Tzaneen, Keitt, 1982	H. Britz	VCG4	<i>MAT-1</i>	AF236773
MRC 7873	South Africa, Tzaneen, Keitt, 1982	H. Britz	VCG4	<i>MAT-1</i>	AF236774
MRC 7875	South Africa, Tzaneen, Keitt, 1982	H. Britz	VCG4	<i>MAT-1</i>	AF236775
MRC 7876	South Africa, Tzaneen, Keitt, 1982	H. Britz	VCG4	<i>MAT-1</i>	AF236776
MRC 7877	South Africa, Tzaneen, Keitt, 1982	H. Britz	VCG4	<i>MAT-1</i>	AF236777

<sup>1</sup> MRC = Collection of the Programme on Mycotoxins and Experimental Carcinogenesis, Medical Research Council, Tygerberg, South Africa.

<sup>2</sup> The exact location of isolation of strains in Kwa-Zulu/Natal, South Africa, are not known.

<sup>3</sup> N/A, the *M. indica* cultivar from which the strains were isolated is not available.

<sup>4</sup> VCG phenotypes were determined as described by Correll et al. (2). N/D, not done.

<sup>5</sup> Mating types were assigned using the PCR-based techniques described by Steenkamp et al. (23) and Kerényi et al. (7).



**Histone H3**  
469 bp; 206 steps  
RI = 0.927; CI = 0.743

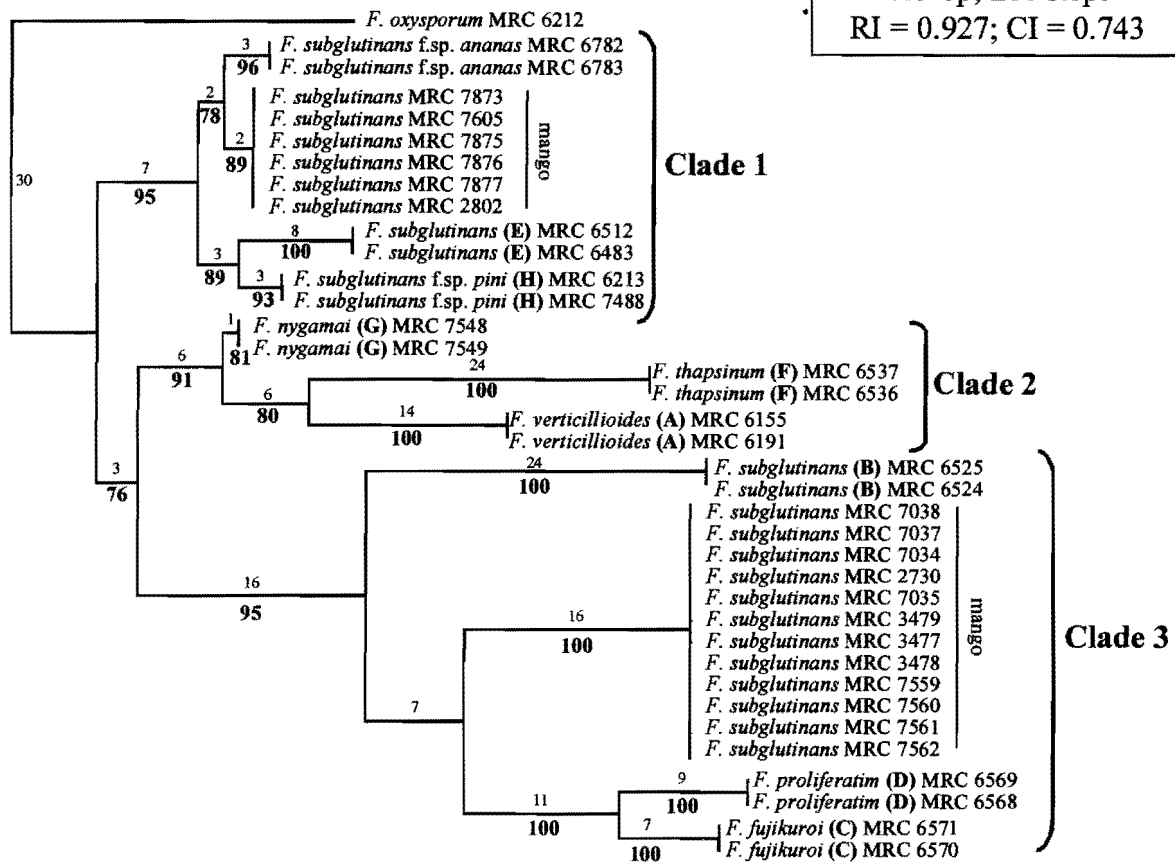

**Figure 1.** Phylogenetic relationships inferred from histone *H3* gene sequence data for the *Fusarium* isolates from the *G. fujikuroi* species complex included in this study. This tree is rooted to *F. oxysporum* and the bold letters in parentheses refer to the *G. fujikuroi* mating populations A to H. Branch lengths are indicated above the internodes and bootstrap values are indicated as percentages in bold digits below the internodes.

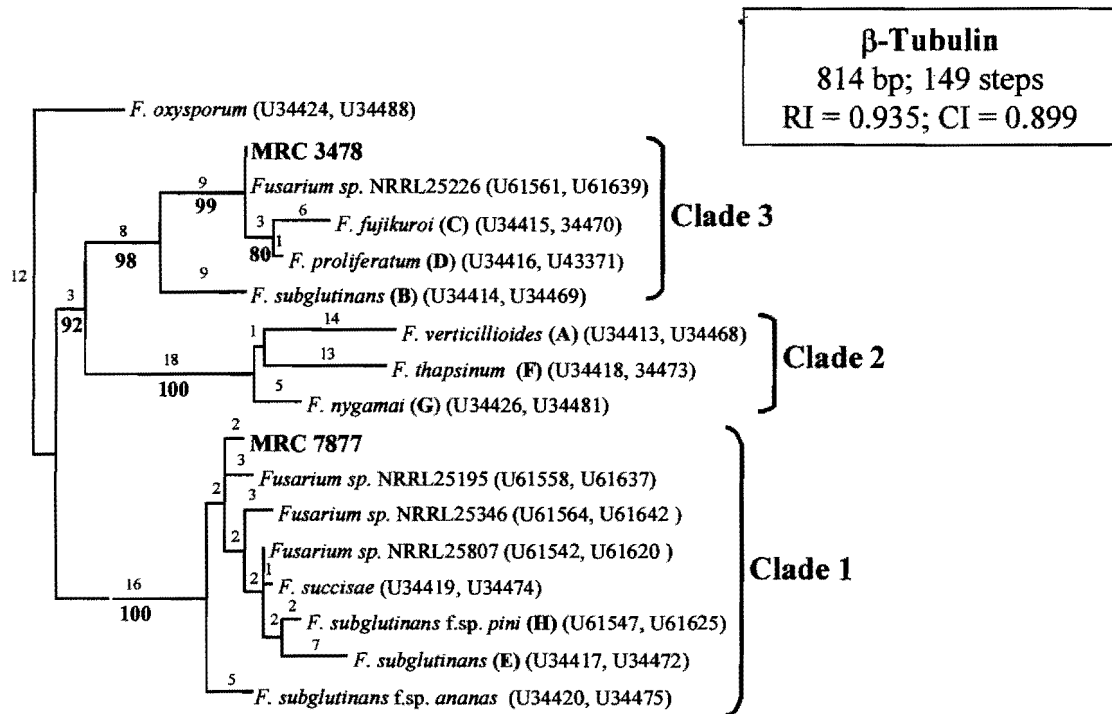

**Figure 2.** Phylogenetic relationships inferred from  $\beta$ -tubulin gene sequence data for the *F. subglutinans* isolates MRC 3478 and MRC 7877 associated with mango malformation, as well as the *G. fujikuroi* mating populations. Also included are *F. subglutinans* f. sp. *ananas*, *F. succisae* and *Fusarium* strains NRRL 25226, 25195, 25346 and 25807. This tree is rooted to *F. oxysporum* and the bold letters in parentheses refer to the *G. fujikuroi* mating populations A to H. Branch lengths are indicated above the internodes and bootstrap values are indicated as percentages in bold digits below the internodes.





# CHAPTER 5

## ***GIBBERELLA FUJIKUROI*** **MATING POPULATION E** **ASSOCIATED WITH MAIZE** **AND TEOSINTE SPECIES**

E.T. Steenkamp<sup>1</sup>, T.A. Coutinho<sup>1</sup>, A.E. Desjardins<sup>2</sup>,  
B.D. Wingfield<sup>1</sup>, M.J. Wingfield<sup>1</sup> and  
W.F.O. Marasas<sup>3</sup>

Tree Pathology Co-operative Programme, Forestry and  
Agricultural Biotechnology Institute (FABI), Departments of  
Genetics, Microbiology and Plant Pathology, University of  
Pretoria, Pretoria, 0002, South Africa<sup>1</sup>;

Mycotoxin Research Unit, National Center for Agricultural  
Utilization of Research, US Department of Agriculture,  
Agricultural Research Service, 1815 N. University Street, Preoria,  
Illinois 61604, USA<sup>2</sup>;

PROMECC, Medical Research Council, P.O. Box 19070, Tygerberg  
7505, South Africa<sup>3</sup>.

## ABSTRACT

Fungal strains identified as *Fusarium subglutinans* form part of the so-called *Gibberella fujikuroi* species complex. *F. subglutinans* is an anamorphic species that is associated with three mating populations (designated B, E and H), as well as a variety of plant hosts. These different *F. subglutinans* strains are generally considered indistinguishable using conventional morphological characters. However, molecular tools have made it possible to show that the *F. subglutinans* strains making up mating populations B, E and H, as well as those associated with the different plant hosts, represent separate species. Recently an additional putative mating population has been reported on the wild teosinte relatives of maize. These isolates are apparently closely related to the pitch canker fungus, *F. subglutinans* f. sp. *pini* (= *F. circinatum*; *G. fujikuroi* mating population H). The aim of the current study was to determine whether the population of *F. subglutinans* from teosinte constitutes a new or an existing lineage within the *G. fujikuroi* complex. For this purpose, portions of the mitochondrial small subunit ribosomal DNA, calmodulin and  $\beta$ -tubulin genes from the fungi were sequenced. Phylogenetic analyses and comparison with sequences from public domain databases indicated that the *F. subglutinans* isolates from teosinte are most closely related to strains in *G. fujikuroi* mating population E. These results were confirmed using sexual compatibility studies. The putative mating population from the wild relatives of maize, therefore, forms part of the existing *G. fujikuroi* mating population E and does not constitute a new lineage in this species complex.



## INTRODUCTION

*Fusarium subglutinans* (Wollew. & Reinking) Nelson, Toussoun & Marasas is an anamorphic species that forms part of the *Gibberella fujikuroi* complex (11, 13). *Fusarium subglutinans* anamorphs are associated with a wide variety of plant hosts such as pine, mango, maize and many more (1, 7, 10, 11, 15, 19, 20, 28). Some of these strains also cause serious diseases and *formae speciales* have consequently been established for strains causing disease on pine and pineapple (3, 28). This anamorphic species is also associated with at least three genetically isolated populations also known as biological species or mating populations B, E and H (1, 7, 10, 11). Mating population B is associated with a variety of hosts including sugarcane (10, 11, 17), whereas mating populations E and H are associated with maize and pine, respectively (1, 10-12, 17, 29).

In recent years, the taxonomy of *F. subglutinans* has been the subject of considerable debate. Much of this is directly linked to the fact that strains associated with the different plants, mating populations and diseases are virtually indistinguishable using morphological characteristics (13-15, 21). The use of molecular tools has clarified many of the taxonomic questions and has provided valuable insight regarding the phylogeny of this anamorphic species (16, 17, 19, 22, 24, Chapters 2 and 4 of this thesis). These DNA based methods have shown that most strains associated with the different plants, *formae speciales* and mating populations represent separate evolutionary lineages. These lineages thus constitute discrete species. Many of these species have subsequently been re-evaluated by using both molecular tools and morphological characters. Hence, *F. subglutinans* strains belonging to mating population H that cause pitch canker of pine was assigned the name *F. circinatum* Nirenberg et O'Donnell (= *F. subglutinans* f. sp. *pini*) (15, 17). Those strains associated with disease of pineapple were named *F. guttiforme* Nirenberg et O'Donnell (= *F. subglutinans* f. sp. *ananas*) (15, 17). *Fusarium* strains representing the B-mating population are currently designated as *F. sacchari* (Butler) W. Gams, whereas those in mating population E are designated *F. subglutinans sensu stricto* (15, 17). In addition to these described species, several other monophyletic lineages displaying morphological characters that are typical of *F. subglutinans*, remain within the *G. fujikuroi* complex (17, 19, 22, Chapter 4 of this thesis).

Recently, a genetically isolated population of *F. subglutinans* isolates has been described by Desjardins et al. (4). This population of isolates originated from domestic maize (*Zea mays* ssp. *mays*) and its wild teosinte relatives (*Zea* spp.) in Mexico and Central America. Isolates of this population were interfertile, but none could mate with the mating type tester strains for mating populations E, B or H. As a result Desjardins et al. (4) suggested that this population might constitute a fourth distinct

mating population associated with *F. subglutinans* anamorphs. However, the description of the fourth mating population was not formalized. The reason was that one strain from this putative population showed a marginal degree of interfertility with a single strain from mating population H. The interfertility of these strains suggested that the population associated with teosinte might be similar or closely related to mating population H. Correct identification of this putative population is important, since isolates belonging to mating population H are serious pathogens of *Pinus* spp. Desjardins et al. (4) also speculated that teosinte and maize could represent sources of inoculum for pitch canker. Elucidation of the relationship between these two groups of fungi is therefore relevant, not only from a taxonomic standpoint but also from a quarantine perspective.

The objective of this study was to characterize a subset of isolates from maize and teosinte that represent the putative new mating population, using cultural and molecular traits. We particularly wished to clarify whether these strains form part of mating population H or another mating population in the *G. fujikuroi* complex. Our aim was four-fold: (i) to determine whether the isolates from teosinte are similar to those associated with pitch canker of pine using the histone *H3* PCR-restriction fragment length (RFLP) method described by Steenkamp et al. (24, Chapter 2 of this thesis); (ii) to identify possible candidates with which the strains isolated from teosinte are conspecific by comparing a portion of their mitochondrial small subunit (mtSSU) ribosomal DNAs to previously published sequences in the National Center for Biotechnology Information (NCBI) database; (iii) to determine the identity of isolates from the putative mating population using phylogenetic analyses of  $\beta$ -tubulin, and calmodulin gene sequences from the identified candidates and *F. subglutinans* isolates associated with maize and teosinte; and (iv) to challenge our hypothesis using sexual compatibility studies.

## MATERIAL AND METHODS

**Fungal isolates.** We included four *F. subglutinans* isolates associated with teosinte (*Zea* spp.) in Mexico (Table 1). Three *F. subglutinans* isolates, previously shown to belong to *G. fujikuroi* mating population E that were isolated from domestic maize (*Z. mays* ssp. *mays*) in South Africa (Table 1), were also included. The single isolate from mating population H (Fsp 34), previously found to be interfertile with an isolate collected from teosinte (Fst 51) (4), was also included. In addition, we included the mating type tester strains for *G. fujikuroi* mating populations E and H.

**DNA isolation.** DNA was isolated using a CTAB (*N*-cetyl-*N,N,N*-trimethyl-ammonium bromide) extraction method described previously (24, Chapter 2 of this thesis).

**Histone *H3* PCR-RFLP.** To determine whether the *F. subglutinans* isolates from teosinte are similar to those associated with pitch canker, we used the *H3* PCR-RFLP technique described by Steenkamp et al. (24, Chapter 2 of this thesis). All of the *F. subglutinans* isolates included in this study were subjected to RFLP-analyses of the amplified portion of their histone *H3* sequences as described by these authors.

**PCR amplification and sequencing.** Portions of the mtSSU, calmodulin and  $\beta$ -tubulin genes were amplified from all the isolates. The primers used for amplification of a portion of the calmodulin gene were CAL-228F (5'-gagttcaaggaggccttctccc-3') and CAL-737R (5'-catctttctggccatcatgg-3') (2). To amplify part of the  $\beta$ -tubulin gene the primers Bt1-a (5'-ttccccgctctccacttctcatg-3') and Bt1-b (5'-gacgagatcggttcatgttgaactc-3') (6) were used. The primers MS1 (5'-cagcagtcaagaatattagcaatg-3') and MS2 (5'-gcggattatcgaattaaataac-3') (30) were used for amplification of part of the mtSSU. PCR reaction and cycling conditions were similar to those described previously (2, 6, 30). After PCR, the products were purified with a QIAquick PCR Purification Kit (Qiagen GmbH, Hilden, Germany) and sequenced in both directions with the respective primers mentioned. Reactions were performed on an ABI PRISM™ 377 automated DNA sequencer, with an ABI PRISM™ Dye Terminator Cycle Sequencing Ready Reaction Kit (Perkin Elmer, Warrington, United Kingdom). Sequences were analyzed with Sequence Navigator version 1.0.1.™ (Perkin Elmer Applied BioSystems, Inc., Foster City, CA).

**Identification of possible conspecific candidates.** To identify *Fusarium* strains with which the isolates from teosinte are possibly conspecific, we used the internet-based programme BLAST (<http://www.ncbi.nlm.nih.gov/cgi-bin/BLAST/>). This programme was used to compare the mtSSU sequences for the isolates from teosinte to those for other *Fusarium* spp. in the in NCBI nucleotide database. The reason for using mtSSU sequences, was that this database contains a considerable



number of *Fusarium*-related mtSSU entries. We also sequenced a larger portion of this gene [~680 base pairs (bp)] than for the  $\beta$ -tubulin and calmodulin genes. From the analyses using BLAST, all *Fusarium* strains with mtSSU sequences displaying more than 98% homology to those for the isolates from teosinte, were identified. These were considered possible candidates with which the isolates from teosinte are conspecific.

**Phylogenetic analyses.** Phylogenetic analyses were performed using the calmodulin and  $\beta$ -tubulin gene sequences for all the isolates included in this study. We also included calmodulin and  $\beta$ -tubulin gene sequences (obtained from GenBank) for the six candidates that are potentially conspecific with the *Fusarium* strains isolated from teosinte. In addition, we included the sequences for the remaining species in the so-called 'American Clade' of the *G. fujikuroi* complex (17). They were *F. guttiforme*, *F. circinatum*, *F. bulbicola*, *F. anthophilum*, *F. succisae* and *F. begoniae*. For comparative purposes the calmodulin and  $\beta$ -tubulin gene sequences for the A-, C-, D-, F- and G-mating populations of the *G. fujikuroi* complex were also included [see O'Donnell et al. (19) for GenBank accession numbers]. All sequences were aligned manually by inserting gaps (see Appendix 4 for aligned sequences). Phylogenetic analyses using parsimony were performed with PAUP (Phylogenetic Analysis Using Parsimony) version 4.0b1 (26). Gaps were treated as missing characters in heuristic searches, with tree-bisection-reconnection branch swapping and MULTREES (saving of all optimal trees) effective. Partition homogeneity tests were performed as previously described (18, 19). Bootstrap analyses were based on 1,000 replications.

**Sexual compatibility tests and identification of mating types.** All the *F. subglutinans* isolates from maize in South Africa and teosinte in Mexico were crossed with one another. We also attempted to repeat the previously reported (4) sexual interaction between an isolate from the H-mating population (Fsp 34) and an individual (Fst 51) from teosinte. For this purpose isolate Fsp 34 were crossed to all the isolates from maize and teosinte, as well as the mating type tester strains for mating populations E and H. To simplify these sexual compatibility tests, the mating types of the different *F. subglutinans* isolates were determined using the PCR-based technique reported by Steenkamp et al. (25, Chapter 3 of this thesis). Isolates with the *MAT-1* mating type were only crossed to those with *MAT-2* mating types and vice versa. Matings were done using previously published techniques (1, 8). Furthermore, because of the relatively low degree of female fertility among the isolates from Mexico (4), these isolates were used only as males in the crosses performed here. Crosses were scored as positives when viable ascospores were produced (1).

## RESULTS

**Histone H3 PCR-RFLP.** All of the *F. subglutinans* isolates associated with maize and teosinte displayed similar RFLP-profiles. These were similar to those of the E-mating type tester strains. The single isolate associated with pine (Fsp 34) that was previously found to be interfertile with an isolate associated with teosinte, displayed an RFLP-profile similar to those generated for the H-mating type tester strains (Fig. 1).

**PCR amplification and sequencing.** We amplified and sequenced ~680 bp fragments of the mtSSU, ~400 bp of the calmodulin and ~300 bp of the  $\beta$ -tubulin genes. The mtSSU sequences for the four different *F. subglutinans* isolates associated with teosinte were identical. They were also identical to those of the isolates from maize, as well as the mating type tester strains for mating population E. The sequenced portions of the calmodulin and  $\beta$ -tubulin genes of these fungi displayed some nucleotide differences, but were almost identical (>99.7% and >99.3% similarity, respectively). The calmodulin and  $\beta$ -tubulin sequences for the isolates from teosinte and maize were also very similar to those representing mating population H (>98%).

**Identification of possible conspecific candidates.** Six *Fusarium* strains in the NCBI nucleotide database displayed mtSSU sequences that were more than 98% homologous to those for the isolates from teosinte. The six strains were considered candidates that are possibly conspecific with the isolates from teosinte. They included two *F. subglutinans* strains (NRRL22016 and NRRL25622) and *F. bactridioides*. The remaining three *Fusarium* strains were NRRL29123, NRRL29124 and NRRL25623. The GenBank accession numbers for the mtSSU sequences of these strains are FSU34501, AF158292, FBU34518, AF158300, AF158301 and AF158291, respectively. The *F. subglutinans* strains NRRL22016 and NRRL25622 belong to *G. fujikuroi* mating population E and were isolated from maize in the United States and South Africa, respectively (19, 24, Chapter 2 of this thesis). Strain NRRL22016 is further one of the E-mating type testers (MRC6512) included in this study (17). *Fusarium* strain NRRL25623 was collected from mango in South Africa (19, 22, 23, Chapter 4 of this thesis). *Fusarium* strains NRRL29123 and NRRL29124 were both isolated from *Bidens pilosa* in the United States (19).

**Phylogenetic analyses.** Gene trees were generated from both the calmodulin and  $\beta$ -tubulin data sets. Their topologies were similar and the partition homogeneity test indicated that these genes evolve at comparable rates, thus representing homogenous partitions ( $P = 1.0$ ). For this reason the calmodulin and  $\beta$ -tubulin data sets were combined to produce 12 most parsimonious trees (Fig. 2).

These trees were congruent with those generated from the single-gene data sets.

**Sexual compatibility tests.** The PCR-based method for distinguishing between the two possible mating types of these isolates revealed that MRC 1084, MRC 756, Fst 40 and Fsp 34 were *MAT-1*, whereas MRC 714, Fst 51, Fst 26 and Fst 10 were *MAT-2*. The three *MAT-2* strains collected from teosinte (Fst 51, Fst 26 and Fst 10) were sexually compatible with the *MAT-1* strain MRC 1084 collected from maize in South Africa. The only other positive interaction was between MRC 756 and Fst 51. The *F. subglutinans* strain (Fsp 34) from pine was sexually compatible only with the H-mating type tester MRC 6213. All crosses were highly fertile and numerous perithecia with oozing ascospores were produced. Viability of ascospores ranged from 90 to 96%.

## DISCUSSION

The primary goal of this study was to determine whether the genetically isolated *F. subglutinans* population from maize and its teosinte relatives collected in Mexico (4), represents a previously undescribed lineage. Alternatively, whether these isolates form part of an existing lineage in the *G. fujikuroi* complex. By using a public domain nucleotide database we were able to identify candidate *Fusarium* strains or species that are closely related to or conspecific with the strains isolated from teosinte in Mexico. Furthermore, by generating phylogenies for two unlinked genes, we were able to identify the lineage to which they most probably belong. We were also able to confirm the identity of the lineage associated with Mexican teosinte, using conventional sexual compatibility studies.

Application of the histone *H3* PCR-RFLP technique indicated the isolates from teosinte are different from those associated with pine (Fig. 1). This is because distinctly different histone *H3* PCR-RFLP profiles were obtained for the isolates associated with pine and *Zea* spp. The fact that similar profiles were generated for the isolates associated with maize, teosinte and mating population E, further indicated a close relationship between these fungi. This relationship was also reflected in their mtSSU sequences, which were identical. However, the isolates from teosinte could not be positively assigned to *G. fujikuroi* mating population E (*F. subglutinans sensu stricto*), based on mtSSU sequence data alone. This was because two or more distinct *Fusarium* species can have identical mtSSU sequences (19). We, therefore, proceeded to identify other possible candidate isolates that could be conspecific with the isolates from teosinte.

The six candidate *Fusarium* strains with which the isolates from teosinte are possibly conspecific, included two described species and four undescribed *Fusarium* strains. As expected one of the described species was *F. subglutinans sensu stricto*. The other species was *F. bactridioides*, which is morphologically distinct from *F. subglutinans* and was previously classified in the *Fusarium* Section *Discolor* (13). The four undescribed candidates all display morphological characters typical of *F. subglutinans* (19, 22, 24, Chapters 2 and 4 of this thesis). Three of these undescribed fungi were previously shown to represent discrete species in the *G. fujikuroi* complex (19, 22, Chapter 4 of this thesis). The fourth undescribed *Fusarium* candidate was previously shown to belong to the E-mating population (24, Chapter 2 of this thesis).

In an attempt to determine which of the six possible candidates were the most closely related to or conspecific with the isolates associated with teosinte, phylogenetic analyses were performed. The



analyses were based on only the sequences for calmodulin and  $\beta$ -tubulin. The mtSSU sequences were excluded from these analyses, since they lack sufficient shared (synapomorphic) and unique derived (autapomorphic) characters (19). The phylogenies that were reconstructed using the calmodulin and  $\beta$ -tubulin genes (single or combined sequence data sets) indicated that the isolates from teosinte are closely related to the isolates from maize and mating population E, as well as *F. bactridioides* (Fig. 2). The sequenced portions of the *F. bactridioides* calmodulin and  $\beta$ -tubulin genes are, however, 4 to 6 bp different from those for the isolates associated with teosinte and maize. The isolates associated with maize, teosinte and mating population E never differ by more than 3 bp, suggesting that they are more closely related to one another than to *F. bactridioides*. We confirmed this hypothesis using sexual compatibility studies.

The results presented in this study strongly support the conspecificity of the isolates from teosinte in Mexico, maize in South Africa and the members of *G. fujikuroi* mating population E (*F. subglutinans sensu stricto*). Three lines of molecular evidence suggested this relationship. Firstly, identical *H3* PCR-RFLP profiles are generated for these isolates. Secondly, the sequenced portions for their mtSSU are identical. Thirdly, phylogenetic analyses group these isolates together. The conspecificity of these isolates was also confirmed using conventional sexual compatibility studies. Two South African isolates from maize, that were previously shown to belong to the E-mating population (24, Chapter 2 of this thesis), were interfertile with three of the Mexican isolates from teosinte. The population from teosinte in Mexico and Central America is, therefore, part of the *G. fujikuroi* mating population E and not unique, as previously suggested (4).

The *F. subglutinans* isolates associated with maize, teosinte and mating population E appear to be subdivided into at least two phylogenetic groups (Fig. 2). This subdivision does not appear to be related to host or geographic origin, since isolates from teosinte in Mexico are found in both clusters, which is also true for the isolates from maize in South Africa. Although the bootstrap support for these groups are weak, their existence is confirmed by previous studies (19, 24, Chapter 2 of this thesis). Steenkamp et al. (24, Chapter 2 of this thesis) and O'Donnell et al. (19) both showed the separation of mating population E into subgroups. However, as reported here and elsewhere, individuals from both groups are sexually compatible with individuals from the other group (4, 24, Chapter 2 of this thesis). Since the present study and those of Steenkamp et al. (24, Chapter 2 of this thesis) and O'Donnell et al. (19) used different sets of isolates, no clear conclusions can be drawn regarding the relationships among these fungi. Application of phylogenetic tools to address questions on the population biology (5, 9, 27) of this group of fungi might reveal that they are diverging into discrete lineages, yet sufficiently similar to allow genetic exchange via sexual reproduction. If this is the case, the

significance of the term 'mating population' and its relatedness to aspects such as pathology, ecology and taxonomy needs to be re-evaluated.

Our data (Figs. 1 and 2) did not allow us to substantiate the hypothesis that the population sampled from teosinte and that from *G. fujikuroi* mating population H, share an unusually close relationship (4). Although both these populations form part of the so-called 'American Clade' proposed by O'Donnell et al. (17), this clade also includes other species that are phylogenetically closely associated with mating populations E and H (Fig. 1). We were further unable to reproduce the unusual sexual interaction between a single isolate (Fst 51 and Fsp 34) from each of these populations, reported by Desjardins et al. (4). We believe that this cross represents a hybrid interaction forced by favorable conditions. Whether such interactions also occur in nature requires further investigation. However, this type of interaction would not be impossible if one takes into account the fact that both these species probably co-evolved with their respective hosts, which have overlapping geographic ranges. If mating populations E and H also share a recent common ancestor, some individuals in both species might have retained sufficient 'common' genetic background to allow sexual recombination. Irrespective of whether these mating populations share a common origin or not, various researchers have shown that they are specific to their respective hosts and that there is no reciprocal pathogenicity between them (3, 11, 29). We, therefore, conclude that it is highly unlikely that the pitch canker disease of *Pinus* spp. can be caused by the *F. subglutinans* strains from mating population E that are found on maize and teosinte.

This and other studies have clearly shown that distinguishing the different *F. subglutinans* lineages that are associated with the different plant hosts and mating populations is troublesome (22, 23, Chapter 4 of this thesis). Traits such as morphology and host often result in ambiguous identifications. Although sexual compatibility studies can, to some extent, help in the identification process, this study clearly illustrated how the biological species concept can obscure relationships. We conclude that fungi displaying morphological characters typical of *F. subglutinans* can only be unequivocally identified using DNA sequence analyses. We further emphasize the need for formal description of these *Fusarium* lineages as species. This would greatly assist plant pathologists and mycologists to successfully distinguish between the species representing *F. subglutinans sensu lato*.

## REFERENCES

1. Britz, H., T. A. Coutinho, M. J. Wingfield, W. F. O. Marasas, T. R. Gordon, and J. F. Leslie. 1999. *Fusarium subglutinans* f. sp. *pini* represents a distinct mating population in the *Gibberella fujikuroi* species complex. *Appl. Environ. Microbiol.* **65**:1198-1201.
2. Carbone, I., and L. M. Kohn. 1999. A method for designing primer sets for speciation studies in filamentous ascomycetes. *Mycologia.* **91**:553-556.
3. Correll, J. C., T. R. Gordon, A. H. McCain, J. W. Fox, C. S. Koehler, D. L. Wood, and M. E. Schultz. 1991. Pitch canker disease in California: pathogenicity, distribution and canker development on Monterey pine (*Pinus radiata*). *Plant Dis.* **75**:676-682.
4. Desjardins, A. E., R. D. Plattner, and T. R. Gordon. 2000. *Gibberella fujikuroi* mating population A and *Fusarium subglutinans* from teosinte species and maize from Mexico and Central America. *Mycol. Res.* **104**:865-872.
5. Geiser, D. M., J. I. Pitt, and J. W. Taylor. 1998. Cryptic speciation and recombination in the aflatoxin-producing fungus *Aspergillus flavus*. *Proc. Natl. Acad. Sci. USA.* **95**:388-393.
6. Glass, N. L., and G. C. Donaldson. 1995. Development of primer sets for use in PCR to amplify conserved genes from filamentous ascomycetes. *Appl. Environ. Microbiol.* **61**:1323-1330.
7. Hsieh, W. H., S. N. Smith, and W. C. Snyder. 1977. Mating groups in *Fusarium moniliforme*. *Phytopathology.* **67**:1041-1043.
8. Klittich, C. J. R., and J. F. Leslie. 1988. Nitrate reduction mutants of *Fusarium moniliforme* (*Gibberella fujikuroi*). *Genetics.* **118**:417-423.
9. Koufopanou, V., A. Burt, and W. J. Taylor. 1997. Concordance of gene genealogies reveals reproductive isolation in the pathogenic fungus *Coccidioides immitis*. *Proc. Natl. Acad. Sci. USA.* **94**:5478-5482.
10. Kuhlman, E. G. 1982. Varieties of *Gibberella fujikuroi* with anamorphs in *Fusarium* section *Liseola*. *Mycologia.* **74**:756-768.
11. Leslie, J. F. 1995. *Gibberella fujikuroi*: Available populations and variable traits. *Can. J. Bot.* **73**:S282-S291.
12. Leslie, J. F. 1991. Mating populations in *Gibberella fujikuroi* (*Fusarium* section *Liseola*). *Phytopathology.* **81**:1058-1060.
13. Nelson, P. E., T. A. Toussoun, and W. F. O. Marasas. 1983. *Fusarium* species: an illustrated manual of identification. Pennsylvania State University Press, University Park.

14. **Nirenberg, H. I.** 1989. Identification of *Fusaria* occurring in Europe on cereals and potatoes. In J. Chelkowski (ed.), *Fusarium: mycotoxins, taxonomy and pathogenicity*. Elsevier, New York.
15. **Nirenberg, H. I., and K. O'Donnell.** 1998. New *Fusarium* species and combinations within the *Gibberella fujikuroi* species complex. *Mycologia*. **90**:434-458.
16. **O'Donnell, K., and E. Cigelnik.** 1997. Two divergent intragenomic rDNA ITS2 types within a monophyletic lineage of the fungus *Fusarium* are nonorthologous. *Mol. Phylogenet. Evol.* **7**:103-116.
17. **O'Donnell, K., E. Cigelnik, and H. I. Nirenberg.** 1998. Molecular systematics and phylogeography of the *Gibberella fujikuroi* species complex. *Mycologia*. **90**:465-493.
18. **O'Donnell, K., H. C. Kistler, E. Cigelnik, and R. C. Ploetz.** 1998. Multiple evolutionary origins of the fungus causing Panama disease of banana: concordant evidence from nuclear, mitochondrial gene sequences. *Proc. Natl. Acad. Sci. USA*. **95**:2044-2049.
19. **O'Donnell, K., H. I. Nirenberg, T. Aoki, and E. Cigelnik.** 2000. A multigene phylogeny of the *Gibberella fujikuroi* species complex: Detection of additional phylogenetically distinct species. *Mycoscience*. **41**:61-78.
20. **Rohrbach, K. G., and J. B. Pfeiffer.** 1976. Susceptibility of pineapple cultivars to fruit disease incited by *Penicillium funiculosum* and *Fusarium moniliforme*. *Phytopathology*. **66**:1386-1390.
21. **Snyder, W. C., and H. N. Hansen.** 1945. The species concept in *Fusarium* with reference to *Discolor* and other sections. *Am. J. Bot.* **32**:657-666.
22. **Steenkamp, E., H. Britz, T. Coutinho, B. Wingfield, W. Marasas, and M. Wingfield.** 2000. Molecular characterization of *Fusarium subglutinans* associated with mango malformation. *Mol. Plant Pathol.* **1**:187-193.
23. **Steenkamp, E. T., B. D. Wingfield, T. A. Coutinho, W. F. O. Marasas, and M. J. Wingfield.** 1998. Histone gene sequence used to distinguish the host-specific groups of *Fusarium subglutinans*. *Proceedings of the 7th International Congress of Plant Pathology*.
24. **Steenkamp, E. T., B. D. Wingfield, T. A. Coutinho, M. J. Wingfield, and W. F. O. Marasas.** 1999. Differentiation of *Fusarium subglutinans* f. sp. *pini* by histone gene sequence data. *Appl. Environ. Microbiol.* **65**:3401-3406.
25. **Steenkamp, E. T., B. D. Wingfield, T. A. Coutinho, K. A. Zeller, M. J. Wingfield, W. F. O. Marasas, and J. F. Leslie.** 2000. PCR-based identification of *MAT-1* and *MAT-2* in the *Gibberella fujikuroi* species complex. *Appl. Environ. Microbiol.* **66**:4378-4382.



26. **Swofford, D. L.** 1998. PAUP\*. Phylogenetic Analysis Using Parsimony (\*and Other Methods). Version 4.0\*. Sinauer Associates, Sunderland, Massachusetts.
27. **Taylor, J. W., D. M. Geiser, A. Burt, and V. Koufopanou.** 1999. The evolutionary biology and population genetics underlying fungal strain typing. *Clin. Microbiol. Rev.* **12**:126-146.
28. **Ventura, J. A., L. Zambolim, and R. L. Gilbertson.** 1993. Pathogenicity of *Fusarium subglutinans* to pineapples. *Fitopatol. Bras. Supl.* **18**:280.
29. **Viljoen, A., M. J. Wingfield, and W. F. O. Marasas.** 1997. Characterization of *Fusarium subglutinans* f. sp. *pini* causing root disease of *Pinus patula* seedlings in South Africa. *Mycol. Res.* **101**:437-445.
30. **White, T. J., T. Bruns, S. Lee, and J. Taylor.** 1990. Amplification and direct sequencing of fungal ribosomal RNA genes for phylogenetics, p. 315-322. *In* M. A. Innis, D. H. Gelfand, J. J. Sninsky, and T. J. White (ed.), PRC protocols. A guide to methods and applications. Academic Press, Inc. Harcourt Brace Jovanovich Publishers, London.

**Table 1.** Hosts, geographic origins and sources of the isolates associated with maize, teosinte and pine used in this study.

Isolate <sup>1</sup>	Host	Geographic origin	Source
(E) MRC 6512; KSU 2192	<i>Z. mays</i> ssp. <i>mays</i>	Illinois, United States	J. F. Leslie
(E) MRC 6483; KSU 990	<i>Z. mays</i> ssp. <i>mays</i>	Illinois, United States	J. F. Leslie
(E) MRC 1084	<i>Z. mays</i> ssp. <i>mays</i>	Eastern Cape, South Africa	W.F.O. Marasas
(E) MRC 756	<i>Z. mays</i> ssp. <i>mays</i>	Mpumalanga, South Africa	W.F.O. Marasas
(E) MRC 714	<i>Z. mays</i> ssp. <i>mays</i>	Northern Province, South Africa	W.F.O. Marasas
Fst 10	<i>Z. diploperennis</i>	Jalisco, Mexico	A. E. Desjardins
Fst 26	<i>Z. mays</i> ssp. <i>mexicana</i>	Michoacan, Mexico	A. E. Desjardins
Fst 40	<i>Z. mays</i> ssp. <i>parviglumis</i>	Guerrero, Mexico	A. E. Desjardins
Fst 51	<i>Z. mays</i> ssp. <i>mexicana</i>	Texcococ, Mexico	A. E. Desjardins
Fsp 34	<i>Pinus</i> spp.	California, United States	T. R. Gordon
(H) MRC 6213	<i>Pinus</i> spp.	Mpumalanga, South Africa	W.F.O. Marasas
(H) MRC 7488	<i>Pinus</i> spp.	Mpumalanga, South Africa	W.F.O. Marasas

<sup>1</sup> Culture collections: MRC = W. F. O. Marasas, Programme on Mycotoxins and Experimental Carcinogenesis (PROMEC), Medical Research Council, Tygerberg, South Africa; KSU = J. F. Leslie, Department of Plant Pathology, Kansas State University, Manhattan Kansas; Fst = A. E. Desjardins, National Center for Agricultural Utilization Research, U.S. Department of Agriculture, Peoria, Illinois; Fsp = T. R. Gordon, Department of Plant Pathology, University of California, Davis, California. *Gibberella fujikuroi* mating population E and H are indicated in parentheses.

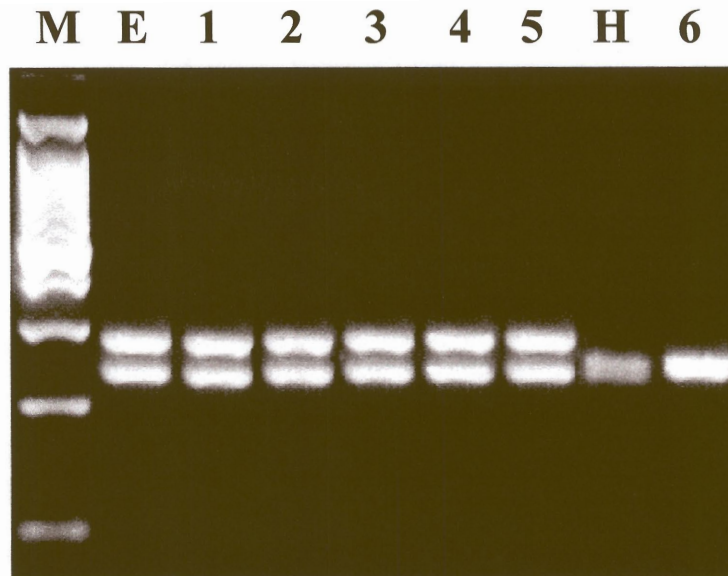

**Figure 1.** PCR-RFLP profiles generated by digesting amplified histone *H3* fragments from the mating type tester strains for mating populations E and H, as well as the isolates from teosinte and Fsp 34, with the restriction enzymes *Dde1* and *Cfo1* according to Steenkamp et al. (24, Chapter 2 of this thesis). Lane M, 100-bp ladder (1500, 1000, 900, 800, 700, 600, 500, 400, 300, 200, 100 bp); Lane E, mating population E; Lane 1, Fst 10; Lane 2, Fst 26; Lane 3, Fst 40; Lane 4, Fst 51; Lane 5, MRC 1084; Lane H, mating population H; Lane 6, Fsp 34.

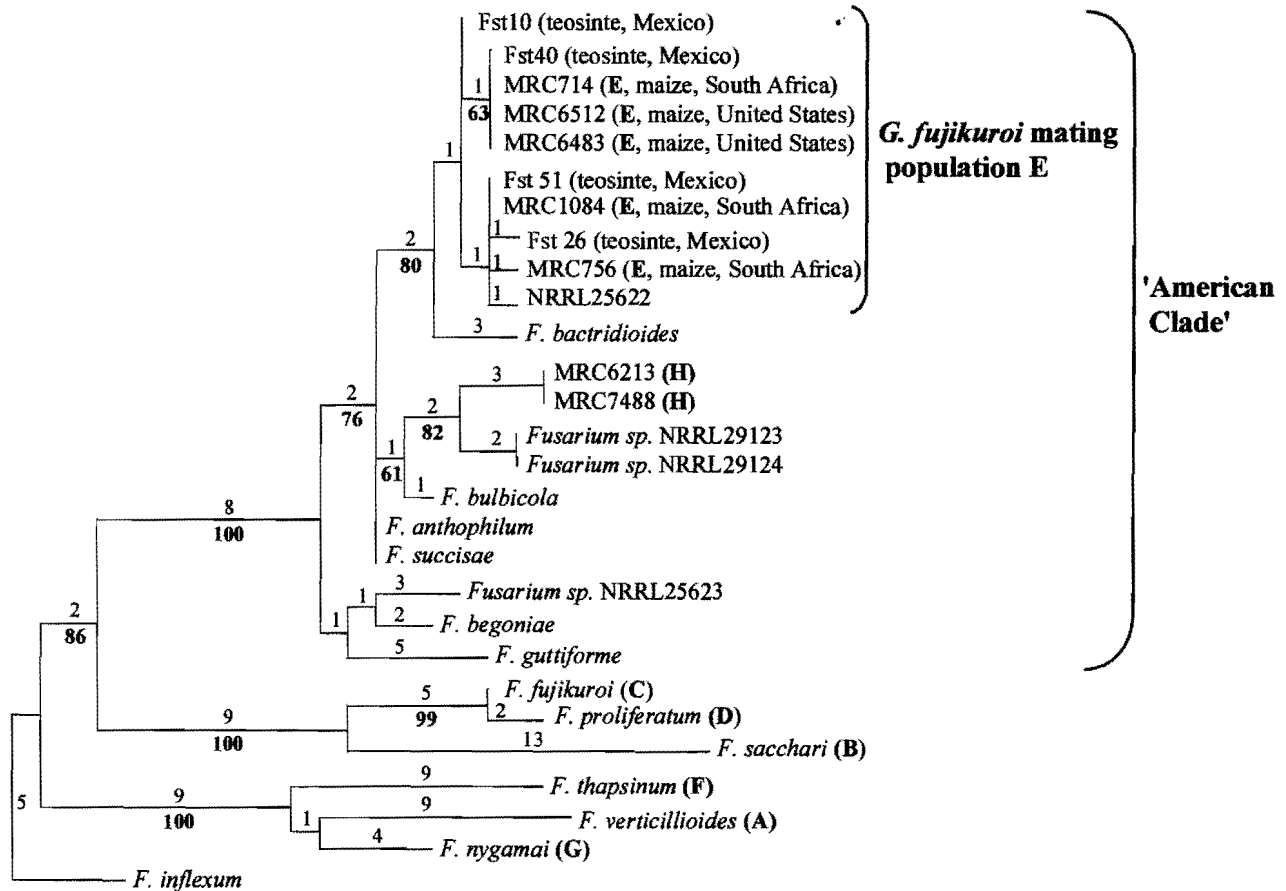

**Figure 2.** Phylogenetic tree reconstructed from the combined calmodulin and  $\beta$ -tubulin datasets obtained from the isolates included in this study, as well as those obtained from GenBank. The geographic origin and host for the *F. subglutinans* isolates are indicated in parentheses. The *G. fujikuroi* mating populations A to H are indicated in bold letters in parentheses. Branch lengths are indicated above the branches and bootstrap values are indicated in bold digits below the internodes. The tree is rooted to *F. inflexum*.





# CHAPTER 6

## CRYPTIC SPECIATION IN *GIBBERELLA FUJIKUROI* MATING POPULATION E

E.T. Steenkamp<sup>1</sup>, T.A. Coutinho<sup>1</sup>, A.E. Desjardins<sup>2</sup>,  
B.D. Wingfield<sup>1</sup>, M.J. Wingfield<sup>1</sup> and  
W.F.O. Marasas<sup>3</sup>

Tree Pathology Co-operative Programme, Forestry and  
Agricultural Biotechnology Institute (FABI), Departments of  
Genetics, Microbiology and Plant Pathology, University of  
Pretoria, Pretoria, 0002, South Africa<sup>1</sup>;

Mycotoxin Research Unit, National Center for Agricultural  
Utilization of Research, US Department of Agriculture,  
Agricultural Research Service, 1815 N. University Street, Preoria,  
Illinois 61604, USA<sup>2</sup>;

PROMECC, Medical Research Council, P.O. Box 19070, Tygerberg  
7505, South Africa<sup>3</sup>.



## ABSTRACT

*Fusarium* spp. that form part of the *Gibberella fujikuroi* complex have been classified using either a biological, morphological or phylogenetic species concept. Most problems with the taxonomy of *Fusarium* spp. in this complex are, however, experienced when the morphological species concept alone is applied. To solve this problem, the morphological species concept has often been applied in combination with the biological species concept. However, the most accurate identifications are obtained when the phylogenetic species concept has been used. Results from recent studies have suggested discordance between the biological and phylogenetic species concepts. A group of *F. subglutinans* isolates, apparently belonging to *G. fujikuroi* mating population E, could be sub-divided into more than one phylogenetic lineage. The aim of this study was to determine whether it represented a speciation event. For this purpose, we included 29 *F. subglutinans* isolates belonging to the E-mating population, that were collected from a wide geographic range. DNA sequence data for six nuclear regions in each of these isolates were obtained and used in phylogenetic analyses. These analyses showed that the E-mating population of the *G. fujikuroi* complex is divided into two reproductively isolated groups, designated Groups 1 and 2. The lack of shared polymorphisms between Groups 1 and 2 further suggested that they represent separate species. The taxonomy of all fungi previously identified as belonging to the E-mating population using the biological species concept should, therefore, be re-evaluated. We also suggest that the biological species concept should be used with caution when dealing with these and similar fungi. Of the three available species concepts, only the phylogenetic species concept allows for unequivocal identification and classification of species in the *G. fujikuroi* complex.

## INTRODUCTION

*Gibberella fujikuroi* (Sawada) Wollenw. is a species complex that encompasses many separate *Fusarium* species (28-30, 34, Chapter 4 of this thesis). In the global setting, species in this complex are important, because of their association with diseases on agronomically important plants (6, 17, 20, 36, 40, 41). These fungi also affect human and animal health, since many species in this complex produce extremely toxic secondary metabolites such as moniliformin, beauvericin, fumonisin and fusaric acid (21-24, 42).

The taxonomy of *Fusarium* species in the *G. fujikuroi* complex has been subject to much controversy (17). This is mainly due to a lack of consensus among researchers on how to define a morphological species concept for *Fusaria* in this complex (11, 26, 27, 33). In an attempt to solve this problem, a biological species concept was introduced, whereby eight biological species, designated as mating populations A to H, have been identified (3, 13, 14, 16-19). The eight biological species, however, exclude more than 80% of the species in this complex, since many have no apparent sexual reproductive cycle or they represent sterile populations. Currently, the only method for classifying all the fungal strains in the *G. fujikuroi* complex is through the application of a so-called phylogenetic species concept (29). With this method, fungi in the *G. fujikuroi* complex are classified into at least 37 different phylogenetically distinct lineages, each constituting a separate species (29, 34, Chapter 4 of this thesis).

In a recent study, ten new and phylogenetically distinct species in the *G. fujikuroi* complex were reported (32). Among these was a *F. subglutinans* (Wollew. & Reinking) Nelson, Toussoun & Marasas strain associated with maize in South Africa. Using gene sequences, this strain was found to be very closely related, but not identical to *G. fujikuroi* mating population E. However, based on the biological species concept, the lineage reported on maize was classified as belonging to the existing E-mating population (35, Chapter 2 of this thesis). This strain was able to produce fertile progeny in a cross with another strain from mating population E (35, Chapter 2 of this thesis). This apparent inconsistency between DNA sequence data and the biological species concept was also highlighted in a recent phylogenetic study of *F. subglutinans* strains associated with the wild relatives of maize (Chapter 5 of this thesis). Strains that were apparently capable of interbreeding formed more than one phylogenetic lineage (Chapter 5 of this thesis).

All of the studies concerning the classification of *Fusarium* strains associated with maize and *G. fujikuroi* mating population E have been based on a small number of isolates (32, 35, Chapters 2 and 5 of this study). No significant conclusions could therefore, be made regarding the possible diversity within the E-mating population or how the phylogenetic species concept might influence our interpretation of the biological species concept. The aim of this study was, therefore,

to address these issues by (i) including several *Fusarium* strains from mating population E that are associated with maize and its wild relatives from a wide geographic range; (ii) to obtain DNA sequence data from six nuclear regions for these strains; and (iii) to use phylogenetic tools (10, 15, 38, 39) to determine whether these isolates are interbreeding in nature and, if not, to define sub-populations within *G. fujikuroi* mating population E.



## MATERIAL AND METHODS

**Fungal isolates.** Twenty-nine *F. subglutinans* isolates associated with maize and teosintes in South Africa, the United States, Mexico and Guatemala were included in this study (Table 1). For outgroup purposes we also included two isolates from *G. fujikuroi* mating populations H.

**DNA isolation, PCR amplification and sequencing.** DNA was isolated using a CTAB (*N*-cetyl-*N,N,N*-trimethyl-ammonium bromide) extraction method (35, Chapter 2 of this thesis).

A portion of three nuclear genes, histone *H3*, calmodulin and  $\beta$ -tubulin, were amplified from all the isolates included in this study. The primers used for amplifying a region of the calmodulin gene were CAL-228F (5'-gagttcaaggaggccttctccc-3') and CAL-737R (5'-catctttctggccatcatgg-3') (5) and the primers Bt1-a (5'-ttccccctctccacttctcatg-3') and Bt1-b (5'-gacgagatcggtcatgtgaactc-3') (12) were used for amplifying a portion of the  $\beta$ -tubulin gene. A section of the histone *H3* gene was amplified using the primers H3-1a (5'-actaagcagaccgcccgcagg-3') and H3-1b (5'-gcgggcgagctggatgtcctt-3') (12). We also used an additional set of primers that amplify three unlinked nuclear regions of unknown function (H. Britz, unpublished data). The first primer set is HB9-a (5'-tcaatacccctcgcttagaa-3') and HB9-b (5'-gaccacagcctcgagaacat-3'), the second is HB14-a (5'-ttccaccatgagaggaaacc-3') and HB14-b (5'-ccattgccaatcttgatcct-3'), and the third HB26-a (5'-gacttgagtatctgcactgc-3') and HB26-b (5'-gaatgtactactcgacgtcg-3').

For amplification of all these loci, the PCR mixture contained 1 mM deoxynucleotide triphosphates (0.25 mM each), 2.5 mM MgCl<sub>2</sub>, 0.2  $\mu$ M of each primer, 0.25 ng/ $\mu$ l DNA, 0.05 U/ $\mu$ l of Super-Therm DNA polymerase [Southern Cross biotechnology (Pty.) Ltd., Cape Town, South Africa] and 1 x Super-Therm reaction buffer. PCR-cycling conditions were as follows: denaturation at 92°C for 20 s, annealing for 20 s at 55°C (calmodulin, tubulin and histone) or 47°C (HB9, HB14 and HB26), and elongation for 20 s at 72°C. This was repeated 30 times and was preceded by an initial denaturation at 92°C for 1 min and followed by a final elongation step at 72°C for 5 min.

After PCR, the products were purified with a QIAquick PCR Purification Kit (Qiagen GmbH, Hilden, Germany) and sequenced in both directions with the respective primers. Reactions were performed on an ABI PRISM™ 377 automated DNA sequencer, with an ABI PRISM™ Dye Terminator Cycle Sequencing Ready Reaction Kit (Perkin Elmer, Warrington, United Kingdom). Sequences were analyzed with Sequence Navigator version 1.0.1.™ (Perkin Elmer Applied BioSystems, Inc., Foster City, CA).

**Phylogenetic analyses.** The data sets obtained for each primer set were aligned manually by inserting gaps (See Appendix 5 for aligned sequences). Phylogenetic analyses were performed with PAUP (Phylogenetic Analysis Using Parsimony) version 4.0b1 (37) where gaps were treated

as fifth characters in heuristic parsimony searches, with tree-bisection-reconnection (TBR) branch swapping and MULTREES (saving of all optimal trees) effective. For bootstrap analyses 1,000 replications were performed.

## RESULTS

**PCR amplification and sequencing.** With the primers used, we were able to amplify and sequence 480 base pairs (bp), 456 bp and 332 bp of the calmodulin,  $\beta$ -tubulin and histone *H3* genes, respectively. For the three regions of unknown function, 250 bp, 235 bp and 236 bp were sequenced for HB9, HB14 and HB26, respectively. Out of the sequenced 1989 nucleotides (nc), 17 nc (0.9%) were polymorphic and none of these had more than two possible alleles. Among the different *F. subglutinans* strains associated with maize and teosinte, between one and six polymorphic nucleotides in each of the six regions were identified (Table 2). Upon combination of the polymorphisms for each individual at all these loci, we recognized seven different genotypes within the set of 29 *F. subglutinans* isolates studied (Table 2). The most frequently sampled genotype was 2-1, which was represented by eight strains associated with maize in South Africa and the United States and teosinte in Mexico and Guatemala. Seven strains displayed genotype 2-3, and were associated with maize in the United States and South Africa, as well as teosinte in Mexico. Five isolates displayed genotype 1-1 and were collected from maize in South Africa and Mexico, as well as Mexican teosinte. Genotype 1-4 was also represented by five strains, all of which were isolated from maize in South Africa and Mexico. Genotype 2-2 was represented by two strains associated with maize in the United States and both genotypes 1-2 and 1-3 were represented by single strains that were isolated from teosinte in Mexico.

**Phylogenetic analyses.** The number of parsimony informative characters in the six data sets ranged from 1 for HB27 to six for histone *H3* (Table 3). In all the data sets, only the  $\beta$ -tubulin sequence harbored a parsimony uninformative character (Table 3, Fig. 1). This variable character was present only in isolate Fst 26. Phylogenetic analyses based on the uninformative, as well as the informative characters generated unique gene genealogies for each of the individual data sets (Fig. 1). In each case, a single reconstruction was generated and the consistency (CI) and retention (RI) indices for each were 1.00 and 1.00, respectively. No homoplastic characters were present in any of the six individual data sets. As a result, all of the single-gene genealogies were of minimal length, i.e. equal to the number of parsimony informative sites. A single most parsimonious tree was also obtained from the combined data sets (Fig. 2). The length of this tree was equal to the number of parsimony informative characters (Table 3), since homoplastic characters were also absent in the combined data sets (CI = 1.00, RI = 1.00). The length of this tree was equal to the summed lengths of the individual gene genealogies (Table 3), which is a distinctive feature of absolute congruence among individual gene genealogies (9, 10, 15, 25, 38).

Clustering within the different genealogies was very similar, but not always identical. For the loci HB9, HB14 and HB27 the isolates were all clustered into two groups that always included

the same isolates (Fig. 1). Both the  $\beta$ -tubulin and calmodulin genealogies consisted of three clusters of isolates, but although there was some overlap, these two groups were different for each gene. The genealogy generated from the histone *H3* data generated four groups of isolates, some of which showed some resemblance to those generated for the other loci.

Phylogenetic analysis of the combined data sets from all the isolates included in this study revealed the presence of two distinct groups among the isolates associated with maize and teosinte. They were designated as Group 1 and 2 (Fig. 3). The genotypes 1-1, 1-2, 1-3 and 1-4 were present in Group 1 and the genotypes 2-1, 2-2 and 2-3 were present in Group 2 (Fig. 2 and 3). Although this clustering was not immediately detectable from the individual gene genealogies, the combined gene genealogy was not discordant with any of them. Strains from Group 1 never clustered with strains from Group 2 and vice versa.



## DISCUSSION

In this study, we set out to use phylogenetic tools to answer what appeared to be a population level question. Although perhaps unusual, this approach is not without precedence and a number of researchers have reported on the value of using such methods (4, 10, 15, 31, 38, 39). Based on previous work (35, Chapters 2 and 5 of this thesis), our null hypothesis was that the set of *F. subglutinans* isolates associated with maize and teosinte, from a wide geographic range, would form part of the existing E-mating population of the *G. fujikuroi* complex. However, based on the data generated in this study, we had to reject this hypothesis. The results clearly show that mating population E is separated into two reproductively isolated populations that most probably constitute sibling, but separate species.

The use of phylogenetic analyses of DNA sequences from multiple loci to identify genetically isolated and recombining populations has been reported by several authors (9, 10, 15, 25, 38, 39). The basic rationale behind these studies involves the detection of congruence or the lack thereof among different gene trees. Incongruence among gene trees from different loci indicates interbreeding among individuals, since sexual recombination 'reshuffles' their genomes. The evolutionary histories of the genes in an individual from an interbreeding population are therefore, unique. However, the genes of individuals from this interbreeding population will have many shared characters or polymorphisms, because of gene flow via sexual reproduction. Individuals from a genetically isolated population will thus lack these shared polymorphisms. This appears to be true for the E-mating population isolates that are separated into Groups 1 and 2 (Fig. 3). The fact that they lack shared polymorphisms (Table 2) is reflected in perfectly concordant gene trees (Figs. 2 and 3). These results thus suggest that Groups 1 and 2 do not interbreed in nature.

Apart from indicating the separation of mating population E into two reproductively isolated populations, our results also suggest that these groups constitute separate species. Evidence for this can be found in the fact that 13 and 16 of the 18 polymorphic sites, identified in this study, are fixed in Groups 1 and 2, respectively (Table 2). Groups 1 and 2 also do not have any shared polymorphisms, which is the normal outcome of speciation events (1, 2, 39). Early in the speciation process, two populations would become genetically isolated, but still share several polymorphisms. Later in this process, shared polymorphisms would be lost and ultimately, the genetically isolated groups would display fixed polymorphisms. At this stage, they no longer represent reproductively isolated populations, but separate species. Our results, therefore, clearly show that Groups 1 and 2 of *G. fujikuroi* mating population E represent distinct species.

Many strains belonging to the E-mating population are sexually incompatible (7, 35, Chapters 2 and 5 of this thesis). A factor that could definitely influence sexual interactions among

these fungi, is the fact that they represent more than one species. This is especially true for the *F. subglutinans* strains that were collected from maize and teosinte in Mexico and Central America (7). For testing the biological species concept in these *F. subglutinans* strains, they were crossed to *F. subglutinans* strains from the E-mating population in the United States. There were, however, no fertile interactions. The results from the current study show that this might have been expected, since the available E-mating population isolates from the United States belongs to Group 2. In contrast, those from Mexico and Central America belongs to both Groups 1 and 2. However, the fact that most of the isolates collected from Mexico and Central America are capable of fertile sexual interaction, even though they represent separate species, cannot be easily explained. Steenkamp et al. (35, Chapter 2 of this thesis) also reported on two South African *F. subglutinans* isolates from Group 1 (MRC 1077 and MRC 837) that were able to interact sexually with a Group 2 isolate (MRC 6483 from the United States).

There are no apparent links between geographic origin or host and the group (Group 1 or 2) to which these *F. subglutinans* isolates from maize and teosinte belong. All the isolates from the United States, however, can be accommodated in Group 1. Two isolates from maize in South Africa and five from teosinte in Mexico and Guatemala also belonged to Group 1. Group 2 isolates were characterized by four South African isolates associated with maize and eight isolates associated with maize and teosinte in Mexico. Both groups can thus be found on teosinte and maize. It is, however, unclear why maize in the United States is apparently only associated with one of these groups.

It is possible that the *F. subglutinans* isolates belonging to mating population E could have evolved from a population resembling isolates found on maize and teosinte in Mexico and Central America. This would be consistent with the fact that both Groups 1 and 2 are present in the population of fungi collected in Central America and Mexico. This also supports the view that the ancestors of domestic maize (*Z. mays* ssp. *mays*) were teosinte-like plants, which most probably evolved in this geographic region (8). It is, therefore, also possible that *F. subglutinans* isolates found on teosintes and maize in this area, resemble the ancestral Groups 1 and 2 of *G. fujikuroi* mating population E.

Group 1 isolates of the E-mating population appear to be more diverse than those representing Group 2. However, the number of isolates representing these groups and the number of polymorphic nucleotides used in this study, are clearly insufficient to draw robust conclusions regarding their population structures. Nevertheless, among the isolates studied, Group 1 is represented by four genotypes, whereas three represented those in Group 2. Group 1 also displayed five non-fixed polymorphisms and Group 2 had only two such polymorphisms. Isolates from Group 1 are also unique in that certain individuals can interact across the species barrier with

isolates in *G. fujikuroi* mating population H (7). All these unique qualities displayed by isolates in Group 1 may suggest that fungi that are much like the modern Group 1 isolates, may have been the "founders" of the E-mating population. It would be interesting to test this hypothesis using a significantly larger set of isolates representing Groups 1 and 2 from as many geographical regions as possible. Such a collection is currently not available to us, but will be assembled in coming years.

The inconsistency between the biological and phylogenetic species concepts illustrated in this study, introduces serious complications for the classification and taxonomy of fungi in the *G. fujikuroi* species complex. This is especially true, when recognizing the fact that many researchers do not have direct access to DNA sequencing facilities. They must thus rely on identifying *Fusarium* spp. by using the morphological and biological species concepts. Problems with using the morphological species concept have been reported by many workers (29, 32, 35, Chapters 2 and 6 of this thesis), but the current study is the first report of disparities using the biological species concept. As we have indicated, the application of the biological species concept can obscure the true phylogenetic relationships among closely related species. The results of sexual compatibility studies using known mating tester strains should thus be interpreted with caution. Although we acknowledge the importance of both morphology and the biological species concept, we recommend the use of the phylogenetic species concept for the unambiguous identification of *Fusarium* species in the *G. fujikuroi* complex.

## REFERENCES

1. **Avise, J. C., and R. M. Ball.** 1990. Principles of genealogical concordance in species concepts and biological taxonomy. *Oxford Surv. Evol. Biol.* **7**:45-67.
2. **Avise, J. C., J. F. Shapira, S. W. Daniel, C. F. Aquadro, and R. A. Lansman.** 1983. Mitochondrial DNA differentiation during the speciation process in *Peromyscus*. *Mol. Biol. Evol.* **1**:38-56.
3. **Britz, H., T. A. Coutinho, M. J. Wingfield, W. F. O. Marasas, T. R. Gordon, and J. F. Leslie.** 1999. *Fusarium subglutinans* f. sp. *pini* represents a distinct mating population in the *Gibberella fujikuroi* species complex. *Appl. Environ. Microbiol.* **65**:1198-1201.
4. **Carbone, I., J. B. Anderson, and L. M. Kohn.** 1999. Patterns of descent in clonal lineages and their multilocus fingerprints are resolved with combined gene genealogies. *Evolution.* **53**:11-21.
5. **Carbone, I., and L. M. Kohn.** 1999. A method for designing primer sets for speciation studies in filamentous ascomycetes. *Mycologia.* **91**:553-556.
6. **Correll, J. C., T. R. Gordon, A. H. McCain, J. W. Fox, C. S. Koehler, D. L. Wood, and M. E. Schultz.** 1991. Pitch canker disease in California: pathogenicity, distribution and canker development on Monterey pine (*Pinus radiata*). *Plant Dis.* **75**:676-682.
7. **Desjardins, A. E., R. D. Plattner, and T. R. Gordon.** 2000. *Gibberella fujikuroi* mating population A and *Fusarium subglutinans* from teosinte species and maize from Mexico and Central America. *Mycol. Res.* **104**:865-872.
8. **Doebley, J.** 1990. Molecular evidence and the evolution of maize. *Econ. Bot.* **44**:6-27.
9. **Dykhuisen, D. E., and L. Green.** 1991. Recombination in *Escherichia coli* and the definition of biological species. *J. Bacteriol.* **173**:7257-7268.
10. **Geiser, D. M., J. I. Pitt, and J. W. Taylor.** 1998. Cryptic speciation and recombination in the aflatoxin-producing fungus *Aspergillus flavus*. *Proc. Natl. Acad. Sci. USA.* **95**:388-393.
11. **Gerlach, W., and H. I. Nirenberg.** 1982. The genus *Fusarium* - A pictorial atlas. *Mitt. Biol. Bundesanst. Land-Forstw. Berlin-Dahlem.* **209**:1-406.
12. **Glass, N. L., and G. C. Donaldson.** 1995. Development of primer sets for use in PCR to amplify conserved genes from filamentous ascomycetes. *Appl. Environ. Microbiol.* **61**:1323-1330.
13. **Hsieh, W. H., S. N. Smith, and W. C. Snyder.** 1977. Mating groups in *Fusarium moniliforme*. *Phytopathology.* **67**:1041-1043.
14. **Klittich, C. J. R., and J. F. Leslie.** 1992. Identification of a second mating population within the *Fusarium moniliforme* anamorph of *Gibberella fujikuroi*. *Mycologia.* **84**:541-547.



15. **Koufopanou, V., A. Burt, and W. J. Taylor.** 1997. Concordance of gene genealogies reveals reproductive isolation in the pathogenic fungus *Coccidioides immitis*. Proc. Natl. Acad. Sci. USA. **94**:5478-5482.
16. **Kuhlman, E. G.** 1982. Varieties of *Gibberella fujikuroi* with anamorphs in *Fusarium* section *Liseola*. Mycologia. **74**:756-768.
17. **Leslie, J. F.** 1995. *Gibberella fujikuroi*: Available populations and variable traits. Can. J. Bot. **73**:S282-S291.
18. **Leslie, J. F.** 1996. Introductory biology of *Fusarium moniliforme*, p. 153-164. In L. S. Jackson, J. W. De Vries, and L. B. Bullerman (ed.), Advances in Experimental Medicine and Biology, vol. 392. Plenum Press, New York.
19. **Leslie, J. F.** 1991. Mating populations in *Gibberella fujikuroi* (*Fusarium* section *Liseola*). Phytopathology. **81**:1058-1060.
20. **Leslie, J. F., C. A. S. Pearson, P. E. Nelson, and T. A. Toussoun.** 1990. *Fusarium* spp. from corn, sorghum and soybean fields in the central and eastern United States. Phytopathology. **80**:343-350.
21. **Leslie, J. F., R. D. Plattner, A. E. Desjardins, and C. J. R. Klittich.** 1992. Fumonisin B1 production by strains from different mating populations of *Gibberella fujikuroi* (*Fusarium* section *Liseola*). Phytopathology. **82**:341-345.
22. **Logrieco, A., A. Moretti, A. Ritieni, J. Chelkowski, C. Altomare, A. Bottalico, and G. Randazzo.** 1993. Natural occurrence of beauvericin in preharvest *Fusarium subglutinans* infected corn ears in Poland. J. Agric. Food Chem. **41**:2149-2152.
23. **Marasas, W. F. O., P. E. Nelson, and T. A. Toussoun.** 1984. Toxigenic *Fusarium* species: identity and mycotoxicology. Pennsylvania State University Press, University Park.
24. **Marasas, W. F. O., P. G. Thiel, C. J. Rabie, P. E. Nelson, and T. A. Toussoun.** 1983. Moniliformin production in *Fusarium* section *Liseola*. Mycologia. **78**:242-247.
25. **Maynard Smith, J., and N. H. Smith.** 1998. Detecting recombination from gene trees. Mol. Biol. Evol. **15**:590-599.
26. **Nelson, P. E., T. A. Toussoun, and W. F. O. Marasas.** 1983. *Fusarium* species: an illustrated manual of identification. Pennsylvania State University Press, University Park.
27. **Nirenberg, H. I., and K. O'Donnell.** 1998. New *Fusarium* species and combinations within the *Gibberella fujikuroi* species complex. Mycologia. **90**:434-458.
28. **O'Donnell, K., and E. Cigelnik.** 1997. Two divergent intragenomic rDNA ITS2 types within a monophyletic lineage of the fungus *Fusarium* are nonorthologous. Mol. Phylogenet. Evol. **7**:103-116.
29. **O'Donnell, K., E. Cigelnik, and H. I. Nirenberg.** 1998. Molecular systematics and

- phylogeography of the *Gibberella fujikuroi* species complex. *Mycologia*. **90**:465-493.
30. **O'Donnell, K., H. C. Kistler, E. Cigelnik, and R. C. Ploetz.** 1998. Multiple evolutionary origins of the fungus causing Panama disease of banana: concordant evidence from nuclear, mitochondrial gene sequences. *Proc. Natl. Acad. Sci. USA*. **95**:2044-2049.
  31. **O'Donnell, K., H. C. Kistler, B. K. Tacke, and H. H. Casper.** 2000. Gene genealogies reveal global phylogenetic structure and reproductive isolation among lineages of *Fusarium graminearum*, the fungus causing wheat scab. *Proc. Natl. Acad. Sci. USA*. **97**:7905-7910.
  32. **O'Donnell, K., H. I. Nirenberg, T. Aoki, and E. Cigelnik.** 2000. A multigene phylogeny of the *Gibberella fujikuroi* species complex: Detection of additional phylogenetically distinct species. *Mycoscience*. **41**:61-78.
  33. **Snyder, W. C., and H. N. Hansen.** 1945. The species concept in *Fusarium* with reference to *Discolor* and other sections. *Am. J. Bot.* **32**:657-666.
  34. **Steenkamp, E., H. Britz, T. Coutinho, B. Wingfield, W. Marasas, and M. Wingfield.** 2000. Molecular characterization of *Fusarium subglutinans* associated with mango malformation. *Mol. Plant Pathol.* **1**:187-193.
  35. **Steenkamp, E. T., B. D. Wingfield, T. A. Coutinho, M. J. Wingfield, and W. F. O. Marasas.** 1999. Differentiation of *Fusarium subglutinans* f. sp. *pini* by histone gene sequence data. *Appl. Environ. Microbiol.* **65**:3401-3406.
  36. **Sun, S.-K., and W. C. Snyder.** 1981. The bakanae disease of the rice plant, p. 104-113. *In* P. E. Nelson, T. A. Toussoun, and R. J. Cook (ed.), *Fusarium: Diseases, biology and taxonomy*. Pennsylvania State University Press, University Park.
  37. **Swofford, D. L.** 1998. PAUP\*. Phylogenetic Analysis Using Parsimony (\*and Other Methods). Version 4.0\*. Sinauer Associates, Sunderland, Massachusetts.
  38. **Taylor, J. W., D. M. Geiser, A. Burt, and V. Koufopanou.** 1999. The evolutionary biology and population genetics underlying fungal strain typing. *Clin. Microbiol. Rev.* **12**:126-146.
  39. **Taylor, J. W., D. J. Jacobson, and M. C. Fisher.** 1999. The evolution of asexual fungi: Reproduction, speciation and classification. *Annu. Rev. Phytopathol.* **37**:197-246.
  40. **Varma, A., V. C. Lele, S. P. Raychaudhuri, A. Ram, and A. Sang.** 1974. Mango malformation: a fungal disease. *Phytopath. Z.* **79**:254-257.
  41. **Ventura, J. A., L. Zambolim, and R. L. Gilbertson.** 1993. Pathogenicity of *Fusarium subglutinans* to pineapples. *Fitopatol. Bras. Supl.* **18**:280.
  42. **Versonder, R. F., A. Logrieco, A. Bottalico, C. Altomare, and S. W. Peterson.** 1995. *Fusarium* species associated with banana fruit rot and their potential toxigenicity. *Mycotoxin Res.* **11**:93-98.

**Table 1.** Hosts, geographic origins and sources of the *Fusarium subglutinans* isolates from mating populations E and H used in this study.

Isolate <sup>1</sup>	Host <sup>2</sup>	Geographic origin <sup>3</sup>	Source
MRC 115	<i>Z. mays</i>	Eastern Cape, South Africa	W.F.O. Marasas
MRC 714	<i>Z. mays</i>	Northern Province, South Africa	W.F.O. Marasas
MRC 756	<i>Z. mays</i>	Mpumalanga, South Africa	W.F.O. Marasas
MRC 837	<i>Z. mays</i>	Eastern Cape, South Africa	W.F.O. Marasas
MRC 1077	<i>Z. mays</i>	Eastern Cape, South Africa	W.F.O. Marasas
MRC 1084	<i>Z. mays</i>	Eastern Cape, South Africa	W.F.O. Marasas
MRC 6483, M 3696, KSU 990	<i>Z. mays</i>	Illinois United States	J.F. Leslie
MRC 6512, M 3693, KSU 2192	<i>Z. mays</i>	Illinois United States	J.F. Leslie
KSU 434, M 6496	<i>Z. mays</i>	Kansas, United States	J.F. Leslie
KSU 507, M 5119	<i>Z. mays</i>	Kansas, United States	J.F. Leslie
KSU 731, M 5126	<i>Z. mays</i>	Kansas, United States	J.F. Leslie
KSU 993, M 3698	<i>Z. mays</i>	Illinois United States	J.F. Leslie
KSU 1257	<i>Z. mays</i>	Kansas, United States	J.F. Leslie
KSU 1417	<i>Z. mays</i>	Kansas, United States	J.F. Leslie
KSU 2921, M 3763	<i>Z. mays</i>	Ohio, United States	J.F. Leslie
KSU 3815, M 851	N/a	N/a	J.F. Leslie
M 3935	<i>Z. mays</i> ssp. <i>mays</i>	N/a, Mexico	A.E. Desjardins
M 3869	<i>Z. mays</i> ssp. <i>mays</i>	N/a, Mexico	A.E. Desjardins
Fst 9	<i>Z. diploperennis</i>	Jalisco, Mexico	A.E. Desjardins
Fst 10	<i>Z. diploperennis</i>	Jalisco, Mexico	A.E. Desjardins
Fst 13, M 7794	<i>Z. luxurians</i>	Chiquimula, Guatemala	A.E. Desjardins
Fst 17, M 7799	<i>Z. mays</i> ssp. <i>huehuetenangensis</i>	Huehuetenen, Guatemala	A.E. Desjardins
Fst 22	<i>Z. mays</i> ssp. <i>mexicana</i>	Durango, Mexico	A.E. Desjardins
Fst 26	<i>Z. mays</i> ssp. <i>mexicana</i>	Michoacan, Mexico	A.E. Desjardins
Fst 40	<i>Z. mays</i> ssp. <i>parviglumis</i>	Guerrero, Mexico	A.E. Desjardins
Fst 51, M 8372	<i>Z. mays</i> ssp. <i>mexicana</i>	Texcoco, Mexico	A.E. Desjardins
Fst 54, M 8375	<i>Z. mays</i> ssp. <i>mays</i>	Texcoco, Mexico	A.E. Desjardins
Fst 58, M 8377	<i>Z. mays</i> ssp. <i>mays</i>	Texcoco, Mexico	A.E. Desjardins
Fst 69, M 8380	<i>Z. mays</i> ssp. <i>mays</i>	Texcoco, Mexico	A.E. Desjardins
Fsp 34	<i>Pinus</i> spp.	California, United States	T.R. Gordon
MR C6213	<i>Pinus</i> spp	Mpumalanga, South Africa	A. Viljoen

<sup>1</sup> Culture collections: MRC = W. F. O. Marasas, Programme on Mycotoxins and Experimental Carcinogenesis (PROMEC), Medical Research Council, Tygerberg, South Africa; KSU = J. F. Leslie, Department of Plant Pathology, Kansas State University, Manhattan, Kansas; Fst = A. E. Desjardins, National Center for Agricultural Utilization Research, U.S. Department of Agriculture, Peoria, Illinois; Fsp = T. R. Gordon, Department of Plant Pathology, University of California, Davis, California; M = D. M. Geiser, Fusarium Research Center, Pennsylvania State University, University park, Pennsylvania.

<sup>2</sup> N/a, information on the plant host from which the strain were isolated is not available.

<sup>3</sup> The exact location of isolation of strains, are not known.

**Table 2.** Summary of the polymorphic alleles or nucleotides (nc) in the six nuclear loci (calmodulin,  $\beta$ -tubulin, histone *H3*, HB9, HB14 and HB26) uncovered among the *Fusarium subglutinans* isolates associated with maize and teosinte.

Isolates	Polymorphisms at six nuclear loci (nc) <sup>1</sup>																		Genotype
	Calmo- dulin		$\beta$ -tubulin			Histone <i>H3</i>						HB14			HB26		HB9		
	33	377	144	204	285	27	99	275	286	351	426	99	230	231	233	69	101	204	
Fst 51, Fst 54, MRC 837, MRC 1077, MRC 1084	T	C	<b>a</b>	T	<b>t</b>	C	<b>c</b>	<b>t</b>	G	C	<b>t</b>	T	-	-	-	A	C	C	1-1
Fst 9	T	C	<b>a</b>	T	<b>t</b>	C	<b>t</b>	<b>c</b>	G	C	<b>c</b>	T	-	-	-	A	C	C	1-2
Fst 26	T	C	<b>a</b>	T	<b>c</b>	C	<b>t</b>	<b>c</b>	G	C	<b>c</b>	T	-	-	-	A	C	C	1-3
M 3869, M 3935, Fst 58, Fst 69, MRC 756	T	C	<b>g</b>	T	<b>t</b>	C	<b>c</b>	<b>t</b>	G	C	<b>t</b>	T	-	-	-	A	C	C	1-4
Fst 10, Fst 13, Fst 17, Fst 22, MRC 115, KSU 1257, KSU 1417, KSU 3815	C	<b>c</b>	A	C	T	<b>c</b>	C	T	A	T	T	C	T	A	A	G	T	G	2-1
KSU 434, KSU 731	C	<b>t</b>	A	C	T	<b>t</b>	C	T	A	T	T	C	T	A	A	G	T	G	2-2
Fst 40, MRC 714, MRC 6512, MRC 6483, KSU 507, KSU 993, KSU 2921	C	<b>t</b>	A	C	T	<b>c</b>	C	T	A	T	T	C	T	A	A	G	T	G	2-3

<sup>1</sup> Alleles that are fixed in either or both populations are indicated in capital letters. Polymorphisms that are not fixed are indicated in bold lower case letters. Horizontal lines (-) indicate deleted nucleotides.



**Table 3.** Number of polymorphic and parsimony informative characters, as well as the actual length of trees generated from the individual and combined sequence data sets for each of the six loci used.

<b>Locus</b>	<b>Informative characters</b>	<b>Polymorphic characters</b>	<b>Tree length<sup>1</sup></b>
Calmodulin	2	2	2
Histone <i>H3</i>	6	6	6
$\beta$ -tubulin	2	3	2
HB9	2	2	2
HB14	4	4	4
HB26	1	1	1
Combined	17	18	17

<sup>1</sup> Note that the actual and expected tree lengths are similar due to the lack of homoplasy or polymorphisms that represent reversals, parallelisms or convergences.

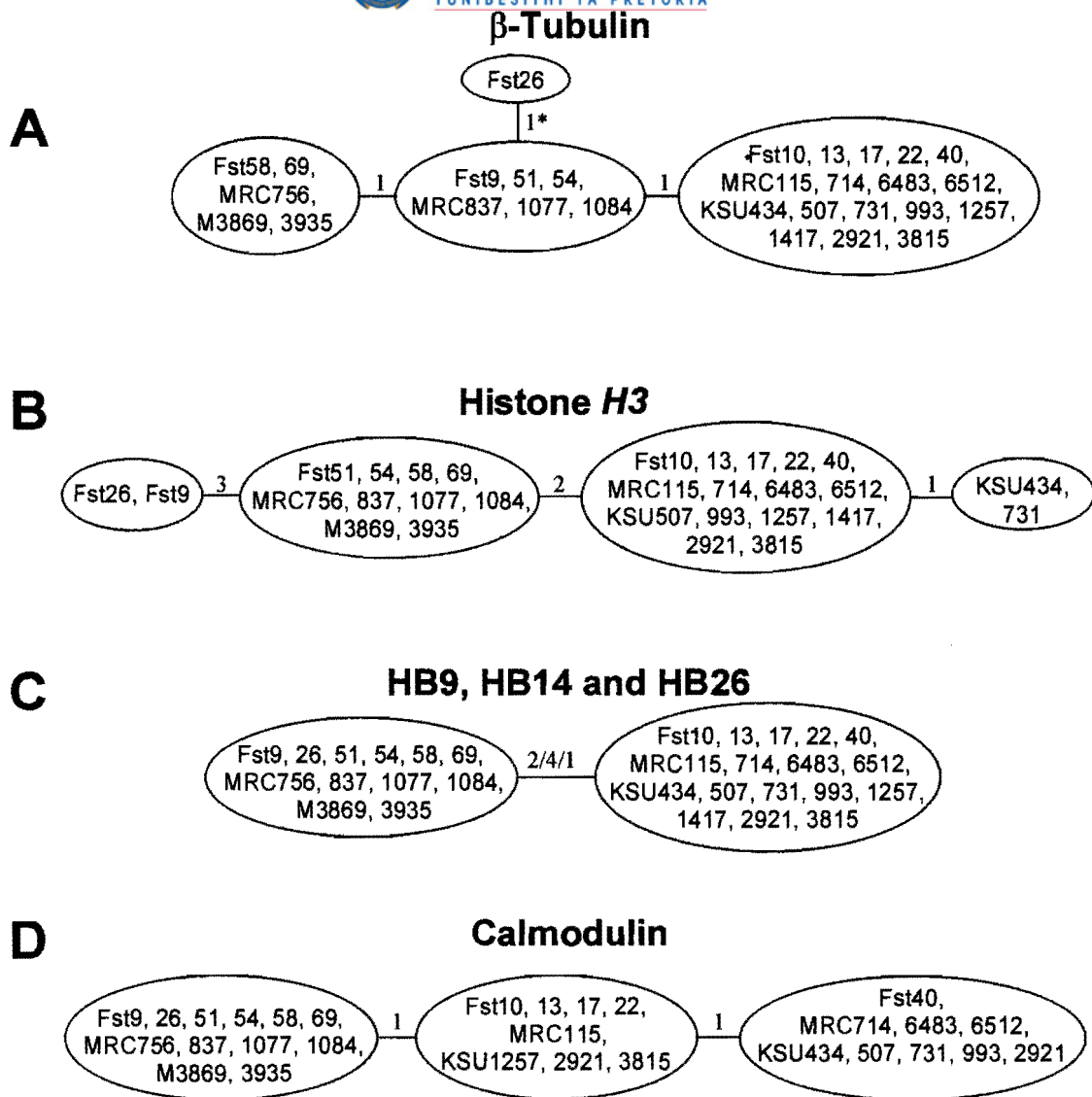

**Figure 1.** Single-gene genealogies generated from the sequence data sets for the six different loci studied in the 29 *F. subglutinans* strains associated with maize and teosinte. In each case only the informative characters were used and one most parsimonious reconstruction was obtained. The branch associated with the single parsimony uninformative character in the  $\beta$ -tubulin data set is indicated with an asterisk (\*). The consistency (CI) and retention (RI) indices for each was 1.00 and 1.00, respectively. **A:**  $\beta$ -tubulin gene genealogy consisting of 2 parsimony informative characters and 2 steps. **B:** Histone *H3* genealogy consisting of 6 parsimony informative characters and 6 steps. **C:** The single-gene genealogy for each of the HB9, HB14 and HB27 nuclear regions. Because the clustering for each of these regions are identical, they are represented by a single tree with lengths 2, 4 and 1, respectively. **D:** Calmodulin gene genealogy consisting of 2 steps.

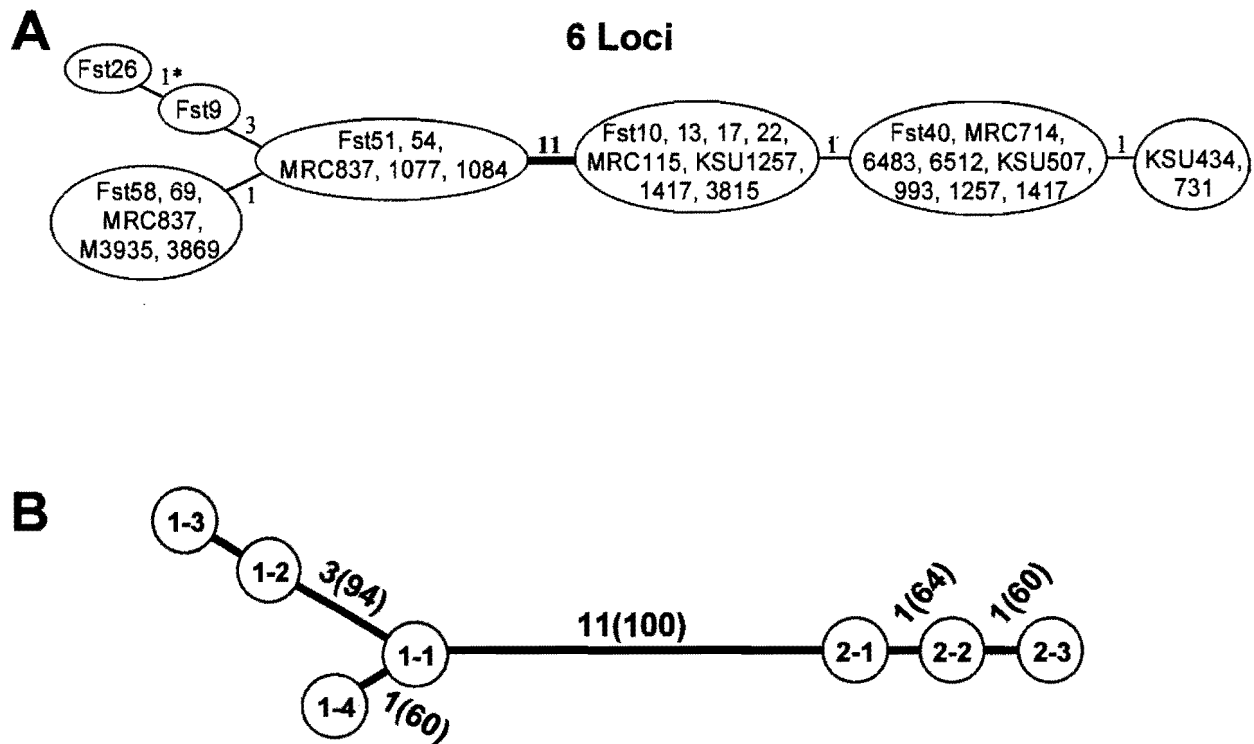

**Figure 2.** **A:** Genealogy generated from the combined data sets using all the parsimony informative characters (37). The branch associated with the single parsimony uninformative character in the  $\beta$ -tubulin data set is indicated with an asterisk (\*). One single most parsimonious reconstruction with a length of 17 steps were obtained (CI = 1.00; RI = 1.00). **B:** The individuals included in each of the seven clusters corresponds with the individuals displaying each of six genotypes. Inclusion of the single uninformative character present in the  $\beta$ -tubulin sequence data set, allows the separation of genotypes 1-2 and 1-3. Bootstrap values are indicated in parentheses.

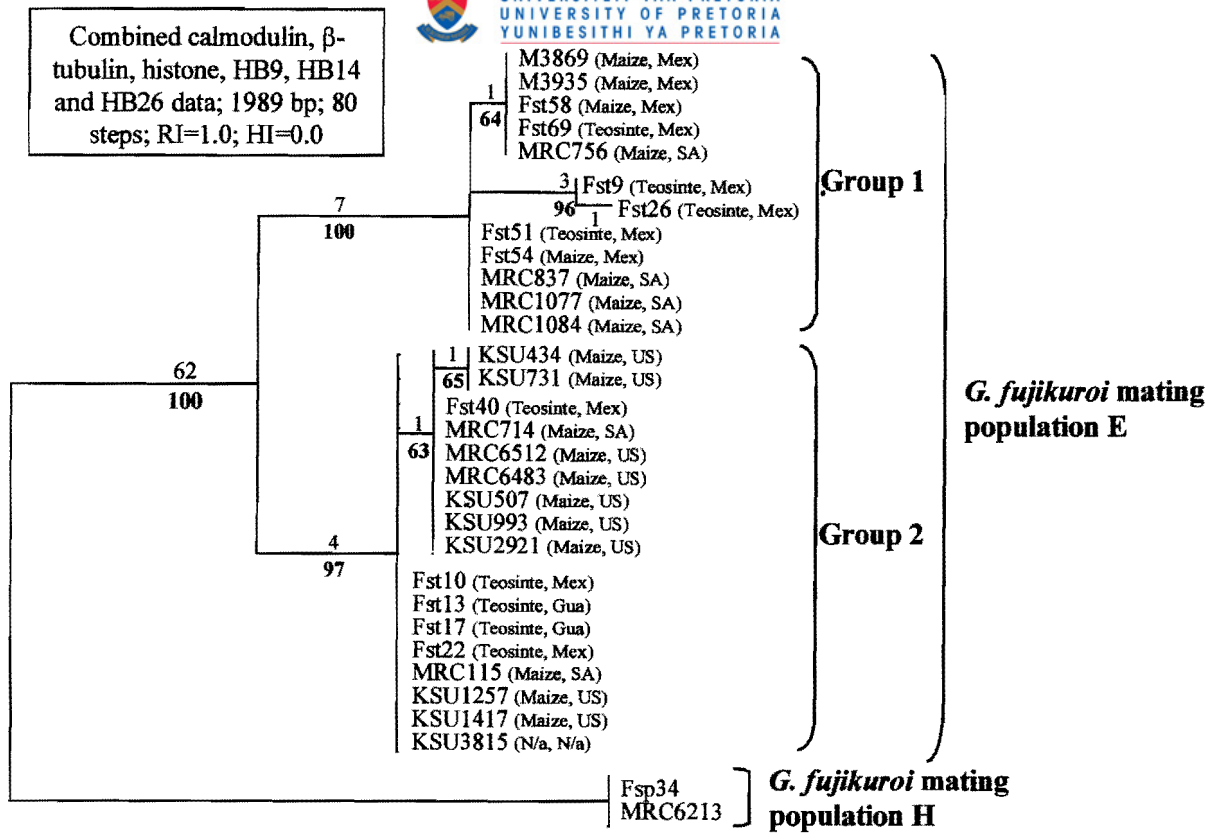

**Figure 3.** A single most parsimonious phylogram generated from the combined sequence data sets obtained from this study. Parsimony informative, as well as parsimony uninformative characters were included. Isolates representing both Groups 1 and 2 of the E-mating population, are included. The host and geographic origin are indicated in parentheses (Mex. = Mexico; SA = South Africa; US = United States; Gua = Guatemala; N/a = not available). The tree is rooted to *G. fujikuroi* mating population H. Branch lengths are indicated above the branches and bootstrap values based on a 1,000 replications, are indicated as bold digits below the branches.





# CHAPTER 7

## A MOLECULAR AND MORPHOLOGICAL COMPARISON OF *FUSARIUM* SPECIES REPRESENTING *F. SUBGLUTINANS SENSU LATO*

E.T. Steenkamp<sup>1</sup>, H. Britz<sup>1</sup>, T.A. Coutinho<sup>1</sup>, B.D.  
Wingfield<sup>1</sup>, M.J. Wingfield<sup>1</sup> and W.F.O. Marasas<sup>2</sup>

Tree Pathology Co-operative Programme, Forestry and  
Agricultural Biotechnology Institute (FABI), Departments of  
Genetics, Microbiology and Plant Pathology, University of  
Pretoria, Pretoria, 0002, South Africa<sup>1</sup>;  
PROMEC, Medical Research Council, P.O. Box 19070, Tygerberg  
7505, South Africa<sup>2</sup>.

## ABSTRACT

*Fusarium subglutinans* forms part of the *Gibberella fujikuroi* complex. Research on the phylogeny of *F. subglutinans* has indicated that it is a polyphyletic taxon (= *F. subglutinans sensu lato*) representing several discreet species. Many of these are important plant pathogens and some are well-known for their capacity to produce toxic secondary metabolites. However, the fungi comprising *F. subglutinans sensu lato* are morphologically cryptic, which has hampered their identification using morphological characters. Although a number of morphological characters have recently been reported as taxonomically useful, these have not been tested on all the known species of *F. subglutinans sensu lato*. The aim of this study was to compare and evaluate the diagnostic value of the morphological characters reported previously, on a larger set of species representing *F. subglutinans sensu lato*. Furthermore, we attempted to compare and distinguish these fungi using DNA-based techniques. From the morphological comparisons, we identified five apparently useful diagnostic characters. These were the origin of conidiophores with respect to hyphae on the substrate surface, conidiophore branching, the number of conidiogenous openings on polyphialides, macroconidial septation and the presence of sterile coiled hyphae. Using these characters, it was possible to distinguish most of the species from each other. For the molecular comparison of the species representing *F. subglutinans sensu lato*, we used DNA sequence from the genes encoding calmodulin,  $\beta$ -tubulin, translation elongation factor 1 $\alpha$  (EF-1 $\alpha$ ) and mitochondrial ribosomal RNA small subunit. These sequences were subjected to restriction analyses using the internet-based programme 'Webcutter'. Four diagnostic restriction enzymes were identified in the EF-1 $\alpha$  gene sequences of these fungi. Using the recognition sites for these restriction enzymes, we generated unique EF-1 $\alpha$  restriction maps for each of the species that can now be used for diagnostic purposes. The use of these morphological and molecular characters allows accurate identification of all the species studied.



## INTRODUCTION

Fungi identified as *Fusarium subglutinans* (Wollew. & Reinking) Nelson, Toussoun & Marasas using morphology have traditionally been classified in the *Fusarium* Section *Liseola* (1, 10, 23, 40). DNA-based approaches to classify these *Fusaria* have revealed the artificial nature of this section (25, 26). As a result *F. subglutinans* is currently classified in the more natural monophyletic *Gibberella fujikuroi* (Sawada) Wollenw. species complex (25, 26). This species complex encompasses more than 30 distinct *Fusarium* lineages without teleomorphs (26, 27, 29, Chapters 4 and 6 of this thesis). In addition, this complex also includes eight biological species or mating populations with teleomorphs in the genus *Gibberella* (2, 11, 13, 14, 16, 17, 24).

Phylogenetic studies have indicated that *F. subglutinans* is a polyphyletic taxon (= *F. subglutinans sensu lato*), representing at least 13 distinct species (25, 26, 28, 29, Chapters 4 and 6 of this thesis). Three of these (mating populations B, E and H) are associated with teleomorphs (2, 15, 16, 19). Most of the species comprising *F. subglutinans sensu lato* further appear to be associated with specific plant hosts, where they may cause serious disease (16, 19, 24, 28, 32, 34-36). As a result, *formae speciales* have been proposed for some of these plant-host associations (5, 35). In addition to the debilitating effect these fungi have on plants, they also pose a threat to human and animal health. This is because some of these species are capable of producing significant levels of toxic secondary metabolites (mycotoxins) (20-22, 36).

Implementation of disease management strategies, as well as preventing the spread of these fungi to new geographic regions, is difficult. This is mainly due to the lack of reliable identification protocols for the species representing *F. subglutinans sensu lato*. These species are all characterized by morphological characters typical of *F. subglutinans* (23). The traditionally used morphological classification systems and the molecular evolution of these fungi are thus incongruent (24, 26, 28, 29, Chapters 4 and 6 of this thesis). Currently, the only morphology-based classification scheme that appears to reflect the evolutionary histories of the fungi in the *G. fujikuroi* complex, is that proposed by Nirenberg and O'Donnell (24). However, this classification enables the differentiation of some, but not all of the species comprising *F. subglutinans sensu lato*. Furthermore, this classification was introduced relatively recently and has not been tested extensively. For this reason many researchers are reluctant to use it and prefer the older, more established classification protocols such as those proposed by Nelson et al. (23). Reliable and unambiguous identification protocols for implementing quarantine measures for this group of fungi are, therefore, lacking.

The objective of this study was to resolve some of the problems associated with identification of *Fusarium* isolates that display morphological traits characteristic of *F.*

*subglutinans*. For this purpose we considered 12 of the 13 *Fusarium* species in this group. Representative isolates for the species reported by O'Donnell et al (28) that were isolated from *Bidens pilosa* were not available and thus not included. The 12 species examined included all eight of the formally described species and four undescribed taxa that are recognized based on sequence data (26, 28-31, Chapters 2 and 4 of this thesis). The one species that we did not include was tOur aim was to compare these taxa using morphological and molecular characters and to identify diagnostic characters to differentiate between them. For this purpose we used the morphological characters reported by Nirenberg and O'Donnell (24). For the molecular comparisons, we used previously published (26, 28) DNA sequences for the three unlinked nuclear genes calmodulin,  $\beta$ -tubulin and translation elongation factor 1 $\alpha$  (EF-1 $\alpha$ ), as well as sequence from the mitochondrial ribosomal RNA small subunit (mtSSU). The gene sequence for the most variable of these genes, EF-1 $\alpha$ , was further analyzed for the presence of diagnostic restriction enzyme recognition sites, which could potentially be used to distinguish the different *Fusarium* species representing *F. subglutinans sensu lato*.



## MATERIAL AND METHODS

**Fungal isolates.** In this study we included representative isolates for 12 taxa recognized as residing in *F. subglutinans sensu lato* (Table 1). These included the ex holotype strains of the six species described by Nirenberg and O'Donnell (24), i.e. *F. begoniae* Nirenberg et O'Donnell, *F. circinatum* Nirenberg et O'Donnell (= *G. fujikuroi* mating population H), *F. concentricum* Nirenberg et O'Donnell, *F. guttiforme* Nirenberg et O'Donnell, *F. pseudocircinatum* Nirenberg et O'Donnell and *F. bulbicola* Nirenberg et O'Donnell. In addition one of the mating tester strains from each of the *G. fujikuroi* mating populations B [= *F. sacchari* (Butler) W. Gams] and E (= *F. subglutinans sensu stricto*) were included. We further included isolates representing four taxa recognized as belonging in *F. subglutinans sensu lato* based on sequence data (26, 28-31, Chapters 2 and 4 of this thesis), but that have yet to be described. These taxa were designated as *Fusarium* sp. 1, 2, 3 and 4. *Fusarium* sp. 1 is associated with *Zea* spp. and is believed to form part of mating population E (28, 30, Chapter 6 of this thesis). *Fusarium* sp. 2 and 3 are associated with mango malformation (27, 29, Chapter 4 of this thesis) and *Fusarium* sp. 4 is associated with ornamental grasses and reeds (27, 31, Chapter 2 of this thesis).

**Morphological comparisons.** All isolates were inoculated onto carnation leaf agar (8) and incubated in the dark for at least two weeks at 20 to 24°C (24). After incubation, the fungal cultures were examined microscopically. The morphological characters reported by Nelson et al. (23) and Nirenberg and O'Donnell (24) were identified, compared among isolates and evaluated for their value in identification.

**Identification of diagnostic restriction enzyme recognition sites.** The DNA sequences for calmodulin,  $\beta$ -tubulin, EF-1 $\alpha$  and mtSSU from each of the eight *Fusarium* species and four undescribed taxa were used. These sequences were obtained from GenBank and were subjected to restriction analyses using Webcutter (<http://www.medkem.gu.se/cutter>). For these analyses, only the restriction sites for commonly available enzymes were included. Diagnostic restriction enzymes were identified and used to construct restriction maps for each of the 12 taxa that make up *F. subglutinans sensu lato*.

**Phylogenetic analyses.** The DNA sequences for the four regions studied, mtSSU, calmodulin,  $\beta$ -tubulin and EF-1 $\alpha$  in the 12 taxa were used. For comparative purposes, the corresponding sequences for the mating tester strains for *G. fujikuroi* mating populations A, C, D, F and G were also included (see appendix 6 for aligned sequences). Phylogenetic analyses using parsimony were performed with PAUP (Phylogenetic Analysis Using Parsimony) version 4.0b1 (33) using the combined information for the four genes, as described previously (28).

## RESULTS

**Morphological comparisons.** Using the morphological characters suggested by Nelson et al. (23), all 12 of the taxa studied, were found to be very similar. Each was characterized by abundant microconidia that were produced on branched and unbranched mono- and polyphialides. These conidia were always produced in false heads and never in chains. Macroconidia were abundant and straight to slightly sickle-shaped. No chlamydospores were observed in any of the taxa examined.

Using the characters proposed by Nirenberg and O'Donnell (24), we were able to distinguish between 11 of the 12 taxa in 'blind tests'. *Fusarium* sp. 1 and *F. subglutinans sensu stricto* could not be differentiated using morphology. Five discriminating characters were identified (Table 2). These characters did not include micro- and macroconidial dimensions and spore types. These latter traits were inordinately variable to be useful taxonomic characters.

The origin of the conidiophores on the aerial mycelium was identified as a valuable diagnostic character and three groups could be distinguished. One group of taxa had conidiophores that emerged directly from the hyphae on the substrate surface. *Fusarium* sp. 4, *F. bulbicola* and *F. circinatum* all produced these 'erect' conidiophores. A second group of taxa had conidiophores that emerged from hyphae that extended horizontally above the substrate surface. *F. begoniae*, *F. concentricum*, *F. pseudocircinatum* and *F. sacchari* produced these 'prostrate' conidiophores. The third group of species was characterized by the presence of both erect and prostrate conidiophores, and included *F. guttiforme* and *F. subglutinans sensu stricto*, as well as *Fusarium* spp. 1, 2 and 3.

The branching pattern of the conidiophores was another character that was useful in differentiating between the taxa. Using this character, three groups of taxa could be identified. The conidiophores of *Fusarium* sp. 4, *F. begoniae* and *F. concentricum* were rarely branched, whereas those of *F. bulbicola* and *F. guttiforme* were strongly branched (Fig. 1). The third group of species was characterized by the production of branched conidiophores with intercalary phialides (referred to as 'proliferating') (Fig. 1). *Fusarium* spp. 1, 2 and 3, as well as *F. circinatum*, *F. pseudocircinatum*, *F. sacchari* and *F. subglutinans sensu stricto* displayed these branched proliferating conidiophores.

The number of conidiogenous openings on the polyphialides was another useful diagnostic character (Fig. 1). Two groups of taxa could be distinguished. The polyphialides of *Fusarium* sp. 1 and 4, as well as *F. begoniae*, *F. bulbicola* and *F. subglutinans sensu stricto* usually had less than three openings. A second group of taxa including *F. circinatum*, *F. concentricum*, *F. guttiforme*, *F. pseudocircinatum*, *F. sacchari* and *Fusarium* spp. 2 and 3 were all characterized by polyphialides with more than three conidiogenous openings.

Macroconidial septation (Fig. 1) could be used to separate the 12 taxa into two groups. One group of taxa had macroconidia with three septa and included *F. begoniae*, *F. circinatum*, *F. guttiforme*, *F. pseudocircinatum*, *F. subglutinans sensu stricto* and *Fusarium* sp. 1. The second group of taxa included *F. bulbicola* and *F. concentricum*, as well as *Fusarium* spp. 2, 3 and 4, which all produced macroconidia with three to five septa. The ability to produce sterile coiled hyphae was also an important diagnostic character. Of the 12 taxa examined, only three were able to produce these coils. They were *Fusarium* sp. 2, *F. pseudocircinatum* and *F. circinatum* (Fig. 1).

**Identification of diagnostic restriction enzyme recognition sites.** Webcutter generated restriction maps for each of the 12 taxa studied. Comparisons of these maps revealed that the sequence for EF-1 $\alpha$  contained sufficient polymorphisms to allow for the identification of diagnostic restriction enzymes. There were too few polymorphic restriction sites in the calmodulin, mtSSU and  $\beta$ -tubulin sequences to allow for differentiation between all the fungi included. The diagnostic restriction enzyme recognition sites identified in the EF-1 $\alpha$  DNA sequence are those for the enzymes *Bgl*1, *Rsa*1, *Sau*3A1 and *Mse*1. Unique EF-1 $\alpha$  restriction maps for each of the eight species and four undescribed taxa representing *F. subglutinans sensu lato* were generated with Webcutter using these recognition sites (Fig. 2).

Based on the presence of *Sau*3A1 restriction sites in the EF-1 $\alpha$  gene for the taxa studied, three groups could be identified (Fig. 2). The first group of taxa was characterized by *Sau*3A1 recognition sites at ~150 base pairs (bp) and ~220 bp, and included *F. begoniae*, *F. bulbicola*, *F. subglutinans sensu stricto*, *F. guttiforme*, *F. pseudocircinatum*, *F. sacchari*, and *Fusarium* sp. 1. The second group included *F. circinatum* and *F. concentricum*, as well as *Fusarium* spp. 3 and 4. They all had *Sau*3A1 recognition sites at ~90 bp, ~150 bp and ~220 bp. *Fusarium* sp. 2 represented the third group. The EF-1 $\alpha$  gene of this taxon was characterized by *Sau*3A1 recognition sites at 92 bp and 150 bp.

Among the 12 taxa three groups could be identified using the *Mse*1 recognition sites (Fig. 2). The first group included those taxa that did not harbor any recognition sites for this enzyme, and included *F. subglutinans sensu stricto*, *F. pseudocircinatum*, *F. sacchari* and *F. concentricum*, as well as *Fusarium* spp. 2 and 3. The second group of taxa included *F. begoniae*, *F. bulbicola*, *F. guttiforme*, *F. circinatum* and *Fusarium* sp. 4. Their EF-1 $\alpha$  sequences were all characterized by the presence of a single *Mse*1 recognition sites at ~400 bp. *Fusarium* sp. 1 represented the third group and was characterized by two (402 bp and 599 bp) *Mse*1 recognition sites.

Based on the presence of *Rsa*1 recognition sites in the EF-1 $\alpha$  gene, four groups of taxa could be identified. The first group included *F. guttiforme* and *F. pseudocircinatum*, which both had *Rsa*1 recognition sites at 47 bp and ~460 bp. The second group included *F. bulbicola*, *F.*

*subglutinans sensu stricto*, *F. concentricum* and *F. circinatum*, as well as *Fusarium* spp. 1, 2, 3 and 4. Their EF-1 $\alpha$  sequences all harbored *Rsa*I recognition sites at 47 bp, ~460 bp and ~610 bp. The two remaining groups were both comprised of single species. One was represented by *F. begoniae* with a *Rsa*I recognition site at 47 bp, while the other was represented by *Fusarium* sp. 1 with *Rsa*I recognition sites at 47 bp, 240 bp, 470 bp and 611 bp.

Restriction analysis with Webcutter using the recognition sites for the enzyme *Bgl*I separated the 12 taxa into two groups. The one group comprised of taxa that had no *Bgl*I restriction sites in their EF-1 $\alpha$  sequences. They were *F. begoniae*, *F. bulbicola*, *F. subglutinans sensu stricto*, *F. guttiforme*, *F. pseudocircinatum*, *F. sacchari*, *F. circinatum*, as well as *Fusarium* spp. 1 and 3. The EF-1 $\alpha$  sequences for *Fusarium* spp. 2 and 4, as well as *F. concentricum* were all characterized by the presence of a single *Bgl*I recognition site at 92 bp.

**Phylogenetic analyses.** From phylogenetic analyses using parsimony of the combined sequence data sets, five most parsimonious trees with similar topologies were generated (Fig. 3). In all the analyses, three major clades, resembling the so-called 'American', 'Asian' and 'African' clades of O'Donnell et al. (26) were present. Among the 12 taxa constituting *F. subglutinans sensu lato*, three taxa, *Fusarium* sp. 3, *F. concentricum* and *F. sacchari*, clustered together with representatives of the C- and D-mating populations in the 'Asian' clade. Only one species, *F. pseudocircinatum*, clustered with representatives of mating populations A, F and G in the 'African' clade. The remaining eight taxa clustered in the so-called 'American' clade.



## DISCUSSION

The primary goal of this study was to compare the different *Fusarium* species displaying morphological characters typical of *F. subglutinans*. From the morphological comparisons we identified five distinguishing diagnostic traits (Table 2). From comparisons of the EF-1 $\alpha$  gene sequences, we further identified four restriction enzymes, from which unique restriction maps for each of the 12 taxa representing *F. subglutinans sensu lato* were constructed (Fig. 2). The use of these morphological and molecular characters allows for differentiation between the 12 best known species comprising *F. subglutinans sensu lato*.

Many previous studies have focussed on the different species representing *F. subglutinans sensu lato* (4, 7, 12, 16, 17, 24-26, 28, 31, 37-39, Chapter 2 of this thesis). Some considered only the phylogeny of these species (12, 25, 26, 28, 31, 37-39, Chapter 2 of this thesis), while others (4, 7, 12, 31, 37, 38, Chapter 2 of this thesis) also attempted species differentiation. However, the methods employed in most of these studies are unsuitable for diagnostic purposes, since they involve methods with low repeatability [e.g. random amplified polymorphic DNAs (RAPDs) (7, 37, 38)] or methods that are technically complicated [e.g. isolation of mitochondrial DNAs for restriction fragment length polymorphisms (RFLP)(4)]. Furthermore, some of these techniques, for example isozyme analyses (12), cannot be used to resolve all the known species comprising *F. subglutinans sensu lato*.

Two previous studies have provided simple diagnostic approaches for differentiating most of the species comprising *F. subglutinans sensu lato* (24, 31, Chapter 2 of this thesis). One of these employed morphological characters (24), whereas the other was DNA-based (31, Chapter 2 of this thesis). However, neither of these studies included all the known species of *F. subglutinans sensu lato*. The diagnostic key of Nirenberg and O'Donnell (24) that is based on morphology, included only the eight formally described species. The histone *H3* PCR-RFLP technique was tested on only six species (31, Chapter 2 of this thesis). The current study is, therefore, the first to attempt to differentiate between most of the species representing *F. subglutinans sensu lato* at both the morphological and molecular levels.

The morphological characters used to distinguish the different *Fusarium* species in this study, were primarily those identified by Nirenberg and O'Donnell (24). The major difference between these characters and those used in the older classifications, is that the traits used to distinguish the different species of *F. subglutinans sensu lato*, allow for a greater level of discrimination. For example, Nelson et al. (23) regard both branched and unbranched conidiophores as a typical feature of *F. subglutinans*. However, distinguishing between branched and unbranched conidiophores allows for differentiation between certain species (Table 2).

Using the diagnostic molecular characters reported here, it was possible to distinguish between all the taxa of *F. subglutinans sensu lato*, included in this study (Fig. 2). This is a major advantage, since not all these species are distinguishable using morphology (Table 2). The two taxa, *Fusarium* sp. 1 and *F. subglutinans sensu stricto*, were indistinguishable using morphology. Another advantage of using these molecular characters rather than the morphological characters, is that using the molecular characters accelerates the identification process. For example, an isolate displaying morphological characters typical of *F. subglutinans* would immediately be diagnosed as *F. begoniae* if its EF-1 $\alpha$  gene harbored a single *Rsa*I restriction site. The morphological characters for identifying this species would only emerge after at least two weeks of incubation in culture.

Two additional characteristics that can be used to distinguish between some the species making up *F. subglutinans sensu lato*, are host range and sexual compatibility. Four of the 12 taxa studied will produce teleomorphs in culture (Table 2). This makes it possible to use mating studies to differentiate species. These species include *F. circinatum* (mating population H) (2), *F. sacchari* (mating population B) (11), *F. subglutinans sensu stricto* (3, 17, 18) and *Fusarium* sp. 1 (31, Chapter 5 of this thesis). However, some of these species are able interact sexually across the species barrier (6, 31, Chapter 2, 5 and 6 of this thesis) and this can cause confusion.

Nine of the 12 taxa included in this study appear to be associated with a specific plant host (Table 2) (5, 9, 16-18, 24, 28, 29, 31, 35, 36, 41, Chapters 2, 4, 5 and 6 of this thesis). However, more than one species may be associated with a single host (5, 16, 24, Chapters 4, 5 and 6 of this thesis). For example, two of the 12 taxa included are associated with pine. One is the pitch canker fungus, *F. circinatum*, while the other is *F. pseudocircinatum* (5, 24). In order to differentiate between the species comprising *F. subglutinans sensu lato*, host range and sexual compatibility should, therefore, both be used with caution.

The molecular phylogenetic work conducted by O'Donnell et al. (26) has indicated that species in the *G. fujikuroi* complex can be separated into three distinct groups. Based on the phylogenetic clustering patterns of these species and the geographic origins of their hosts, O'Donnell et al. (26) proposed a phylogeography hypothesis. According to this hypothesis the evolutionary histories of *Fusarium* spp. in this complex are consistent with species radiations in Africa, South America and Asia, following the fragmentation of the ancient super-continent Gondwana (26). The phylogenetic placement of eight of 12 taxa studied, in any one of the so-called 'African', 'American' or 'Asian' clades (Fig. 3), fits this model (24, 26, 28, 29, Chapter 4 of this thesis). The phylogenetic placement of the remaining four taxa (*F. bulbicola*, *F. pseudocircinatum*, *Fusarium* sp. 3 and *Fusarium* sp. 4) is, however, incongruent with this hypothesis. It has subsequently been suggested that human introduction of plant hosts into new geographic areas, has resulted in the presence of, for example, an 'American' fungus on the 'African' continent (24, 26, 28,

29, Chapter 4 of this thesis). From our study and those of others (24, 28, 29, Chapter 4 of this thesis) it is thus clear that the phylogeography hypothesis (26) needs further verification and refinement.

Application of the diagnostic characters reported in this study, enables differentiation between most of the known *Fusarium* species comprising *F. subglutinans sensu lato* (Table 2 and Fig. 2). From this point of view, the current study is the first to propose both morphological and molecular approaches to identify these fungi. This study will also have a significant impact on agricultural practices since many of the fungi displaying morphological characters typical of *F. subglutinans*, are economically important plant pathogens (5, 9, 35, 36). It will now be possible to correctly identify the fungal pathogen and implement appropriate management strategies.

## REFERENCES

1. **Booth, C.** 1971. The genus *Fusarium*. Commonwealth Agricultural Bureau, Bucks, England.
2. **Britz, H., T. A. Coutinho, M. J. Wingfield, W. F. O. Marasas, T. R. Gordon, and J. F. Leslie.** 1999. *Fusarium subglutinans* f. sp. *pini* represents a distinct mating population in the *Gibberella fujikuroi* species complex. Appl. Environ. Microbiol. **65**:1198-1201.
3. **Chaisrisook, C., and J. F. Leslie.** 1990. Genetic diversity within populations of *Fusarium* section *Liseola* from corn and sorghum in Kansas. Phytopathology. **80**:1042 (Abstr.).
4. **Correll, J. C., T. R. Gordon, and A. H. McCain.** 1992. Genetic diversity in California and Florida populations of the pitch canker fungus of *Fusarium subglutinans* f. sp. *pini*. Phytopathology. **82**:415-420.
5. **Correll, J. C., T. R. Gordon, A. H. McCain, J. W. Fox, C. S. Koehler, D. L. Wood, and M. E. Schultz.** 1991. Pitch canker disease in California: pathogenicity, distribution and canker development on Monterey pine (*Pinus radiata*). Plant Dis. **75**:676-682.
6. **Desjardins, A. E., R. D. Plattner, and T. R. Gordon.** 2000. *Gibberella fujikuroi* mating population A and *Fusarium subglutinans* from teosinte species and maize from Mexico and Central America. Mycol. Res. **104**:865-872.
7. **DuTeau, N. M., and J. F. Leslie.** 1991. RAPD markers for *Gibberella fujikuroi* (*Fusarium* section *Liseola*). Fungal Genet. Newsl. **38**:37.
8. **Fisher, N. L., L. W. Burgess, T. A. Toussoun, and P. E. Nelson.** 1982. Carnation leaves as a substrate and for preserving cultures of *Fusarium* species. Phytopathology. **72**:151-153.
9. **Freeman, S., M. Maimon, and Y. Pinkas.** 1999. Use of GUS transformants of *Fusarium subglutinans* for determining etiology of mango malformation disease. Phytopathology. **89**:456-461.
10. **Gerlach, W., and H. I. Nirenberg.** 1982. The genus *Fusarium* - A pictorial atlas. Mitt. Biol. Bundesanst. Land-Forstw. Berlin-Dahlem. **209**:1-406.
11. **Hsieh, W. H., S. N. Smith, and W. C. Snyder.** 1977. Mating groups in *Fusarium moniliforme*. Phytopathology. **67**:1041-1043.
12. **Huss, M. J., C. L. Campbell, D. B. Jennings, and J. F. Leslie.** 1996. Isozyme variation among biological species in the *Gibberella fujikuroi* species complex (*Fusarium* Section *Liseola*). Appl. Environ. Microbiol. **62**(10):3750-3756.
13. **Klaasen, J. A., and P. E. Nelson.** 1996. Identification of a mating population, *Gibberella nygamai* sp. nov., within the *Fusarium nygamai* anamorph. Mycologia. **88**:965-969.
14. **Klittich, C. J. R., and J. F. Leslie.** 1992. Identification of a second mating population within the *Fusarium moniliforme* anamorph of *Gibberella fujikuroi*. Mycologia. **84**:541-



- 547.
15. **Kuhlman, E. G.** 1982. Varieties of *Gibberella fujikuroi* with anamorphs in *Fusarium* section *Liseola*. *Mycologia*. **74**:756-768.
  16. **Leslie, J. F.** 1995. *Gibberella fujikuroi*: Available populations and variable traits. *Can. J. Bot.* **73**:S282-S291.
  17. **Leslie, J. F.** 1991. Mating populations in *Gibberella fujikuroi* (*Fusarium* section *Liseola*). *Phytopathology*. **81**:1058-1060.
  18. **Leslie, J. F., and M. B. Dickman.** 1991. The fate of DNA encoding hygromycin resistance after meiosis in transformed strains of *Gibberella fujikuroi* (*Fusarium moniliforme*). *Appl. Environ. Microbiol.* **57**:1423-1429.
  19. **Leslie, J. F., C. A. S. Pearson, P. E. Nelson, and T. A. Toussoun.** 1990. *Fusarium* spp. from corn, sorghum and soybean fields in the central and eastern United States. *Phytopathology*. **80**:343-350.
  20. **Logrieco, A., A. Moretti, A. Ritieni, J. Chelkowski, C. Altomare, A. Bottalico, and G. Randazzo.** 1993. Natural occurrence of beauvericin in preharvest *Fusarium subglutinans* infected corn ears in Poland. *J. Agric. Food Chem.* **41**:2149-2152.
  21. **Marasas, W. F. O., P. E. Nelson, and T. A. Toussoun.** 1984. Toxigenic *Fusarium* species: identity and mycotoxicology. Pennsylvania State University Press, University Park.
  22. **Marasas, W. F. O., P. G. Thiel, C. J. Rabie, P. E. Nelson, and T. A. Toussoun.** 1983. Moniliformin production in *Fusarium* section *Liseola*. *Mycologia*. **78**:242-247.
  23. **Nelson, P. E., T. A. Toussoun, and W. F. O. Marasas.** 1983. *Fusarium* species: an illustrated manual of identification. Pennsylvania State University Press, University Park.
  24. **Nirenberg, H. I., and K. O'Donnell.** 1998. New *Fusarium* species and combinations within the *Gibberella fujikuroi* species complex. *Mycologia*. **90**:434-458.
  25. **O'Donnell, K., and E. Cigelnik.** 1997. Two divergent intragenomic rDNA ITS2 types within a monophyletic lineage of the fungus *Fusarium* are nonorthologous. *Mol. Phylogenet. Evol.* **7**:103-116.
  26. **O'Donnell, K., E. Cigelnik, and H. I. Nirenberg.** 1998. Molecular systematics and phylogeography of the *Gibberella fujikuroi* species complex. *Mycologia*. **90**:465-493.
  27. **O'Donnell, K., H. C. Kistler, E. Cigelnik, and R. C. Ploetz.** 1998. Multiple evolutionary origins of the fungus causing Panama disease of banana: concordant evidence from nuclear, mitochondrial gene sequences. *Proc. Natl. Acad. Sci. USA.* **95**:2044-2049.
  28. **O'Donnell, K., H. I. Nirenberg, T. Aoki, and E. Cigelnik.** 2000. A multigene phylogeny of the *Gibberella fujikuroi* species complex: Detection of additional phylogenetically distinct species. *Mycoscience*. **41**:61-78.

29. **Steenkamp, E., H. Britz, T. Coutinho, B. Wingfield, W. Marasas, and M. Wingfield.** 2000. Molecular characterization of *Fusarium subglutinans* associated with mango malformation. *Mol. Plant Pathol.* **1**:187-193.
30. **Steenkamp, E. T., B. D. Wingfield, T. A. Coutinho, W. F. O. Marasas, and M. J. Wingfield.** 1998. Histone gene sequence used to distinguish the host-specific groups of *Fusarium subglutinans*. *Proceedings of the 7th International Congress of Plant Pathology.*
31. **Steenkamp, E. T., B. D. Wingfield, T. A. Coutinho, M. J. Wingfield, and W. F. O. Marasas.** 1999. Differentiation of *Fusarium subglutinans* f. sp. *pini* by histone gene sequence data. *Appl. Environ. Microbiol.* **65**:3401-3406.
32. **Sun, S.-K., and W. C. Snyder.** 1981. The bakanae disease of the rice plant, p. 104-113. *In* P. E. Nelson, T. A. Toussoun, and R. J. Cook (ed.), *Fusarium: Diseases, biology and taxonomy.* Pennsylvania State University Press, University Park.
33. **Swofford, D. L.** 1998. PAUP\*. Phylogenetic Analysis Using Parsimony (\*and Other Methods). Version 4.0\*. Sinauer Associates, Sunderland, Massachusetts.
34. **Varma, A., V. C. Lele, S. P. Raychaudhuri, A. Ram, and A. Sang.** 1974. Mango malformation: a fungal disease. *Phytopath. Z.* **79**:254-257.
35. **Ventura, J. A., L. Zambolim, and R. L. Gilbertson.** 1993. Pathogenicity of *Fusarium subglutinans* to pineapples. *Fitopatol. Bras. Supl.* **18**:280.
36. **Versonder, R. F., A. Logrieco, A. Bottalico, C. Altomare, and S. W. Peterson.** 1995. *Fusarium* species associated with banana fruit rot and their potential toxigenicity. *Mycotoxin Res.* **11**:93-98.
37. **Viljoen, A., M. J. Wingfield, and W. F. O. Marasas.** 1997. Characterization of *Fusarium subglutinans* f. sp. *pini* causing root disease of *Pinus patula* seedlings in South Africa. *Mycol. Res.* **101**:437-445.
38. **Voigt, K., S. Schleier, and B. Brückner.** 1995. Genetic variability in *Gibberella fujikuroi* and some related species of the genus *Fusarium* based on random amplification of polymorphic DNA (RAPD). *Curr. Genet.* **27**:528-535.
39. **Waalwijk, C., J. R. A. de Koning, R. P. Baayen, and W. Gams.** 1996. Discordant groupings of *Fusarium* spp. from the sections *Elegans*, *Liseola* and *Dlaminia* based on ribosomal ITS1 and ITS2 sequences. *Mycologia.* **88**:361-328.
40. **Wollenweber, H. W., and O. A. Reinking.** 1935. Die Fusarien, ihre Beschreibung, Schadwirkung und Bekämpfung. Verlag Paul Parey, Berlin.
41. **Yan, K., M. B. Dickman, J. R. Xu, and J. F. Leslie.** 1993. Sensitivity of field strains of *Gibberella fujikuroi* (*Fusarium* section *Liseola*) to benomyl and hygromycin B. *Mycologia.* **85**:206-213.

**Table 1.** Hosts, geographic origins, and source of the 12 taxa representing *Fusarium subglutinans sensu lato* included in this study.

Species <sup>1</sup>	Host	Geographic origin	Source	Isolate <sup>2</sup>	Reference
<i>F. circinatum</i> (ex T)	<i>Pinus radiata</i>	United States	BBA	MRC 7541; BBA 69720; NRRL 25331	(24)
<i>F. concentricum</i> (ex T)	<i>Musa sapientum</i>	Costa Rica	BBA	MRC7540; BBA 64354; NRRL 25181	(24)
<i>F. begoniae</i> (ex T)	<i>Begonia</i> hybrid	Germany	BBA	MRC 7542; BBA 67781; NRRL 25315	(24)
<i>F. bulbicola</i> (ex T)	<i>Nerine bowdenii</i>	Germany	BBA	MRC 7534; BBA 63628; NRRL 13618	(24)
<i>F. guttiforme</i> (ex T)	<i>Ananas comosus</i>	Brazil	BBA	MRC 7539; BBA 69661; NRRL 25295	(24)
<i>F. pseudocircinatum</i> (ex T)	<i>Solanum</i> sp.	Ghana	BBA	MRC 7536; BBA 69636	(24)
<i>F. sacchari</i>	Laboratory cross		J.F. Leslie	MRC 6525; KSU 3853; M 6866	(2, 12, 41)
<i>F. subglutinans sensu stricto</i>	<i>Zea mays</i>	United States	J.F. Leslie	MRC 6512; KSU 2129; M 3693; NRRL 22016	(2, 12, 41)
<i>Fusarium</i> sp.1	<i>Zea mays</i>	South Africa	W.F.O. Marasas	MRC 1077; NRRL 25622	(28, 31, Chapter 2 of this thesis)
<i>Fusarium</i> sp.2	<i>Mangifera indica</i>	South Africa	W.F.O. Marasas	MRC 2802; NRRL 25623	(28, 29, Chapter 4 of this thesis)
<i>Fusarium</i> sp.3	<i>Mangifera indica</i>	South Africa	W.F.O. Marasas	MRC 2730	(26, 29, Chapter 4 of this thesis)
<i>Fusarium</i> sp.4	Ornamental grass	South Africa	W.F.O. Marasas	MRC 6747; NRRL 26756	(28, 30)

<sup>1</sup> Ex T = ex holotype strain.

<sup>2</sup> Culture collections: MRC = W. F. O. Marasas, Programme on Mycotoxins and Experimental Carcinogenesis (PROMEC), Medical Research Council, Tygerberg, South Africa; KSU = J. F. Leslie, Department of Plant Pathology, Kansas State University, Manhattan, Kansas; BBA = Biologische Bundesanstalt für Land- und Forstwirtschaft, Berlin, Germany; NRRL = Northern Regional Research Laboratory, NCAUR, Preoria, Illinois.

**Table 2.** Summary of the diagnostic characters used to differentiate the 12 taxa representing *Fusarium subglutinans sensu lato* included in this study.

Species	Host specific <sup>2</sup>	Diagnostic characters <sup>1</sup>										
		Sexual stage	Conidiophore origin		Conidiophore branching			Conidiogenous openings		Macroconidia		Sterile coils
			Prostrate	Erect	Rarely branched	Branched	Proliferate	≥ 3	≤ 3	3 septa	3-5 septa	
<i>F. begoniae</i>	<i>Begonia</i> spp.		+		+				+	+		
<i>F. bulbicola</i>	Bulbous plants			+		+			+		+	
<i>F. circinatum</i>	<i>Pinus</i> spp.	+		+		+	+	+		+		+
<i>F. concentricum</i>	-		+		+			+			+	
<i>F. guttiforme</i>	<i>A. comosus</i>		+	+		+		+		+		
<i>F. pseudocircinatum</i>	-		+			+	+	+		+		+
<i>F. sacchari</i>	-	+	+			+	+	+		+		
<i>F. subglutinans sensu stricto</i>	<i>Zea</i> spp.	+	+	+		+	+		+	+		
<i>Fusarium</i> sp.1	<i>Zea</i> spp.	+	+	+		+	+		+	+		
<i>Fusarium</i> sp.2	<i>M. indica</i>		+	+		+	+	+			+	+
<i>Fusarium</i> sp.3	<i>M. indica</i>		+	+		+	+	+			+	
<i>Fusarium</i> sp.4	Grass and reed			+		+			+		+	

<sup>1</sup> The presence of a character is indicated by a plus sign (+).

<sup>2</sup> Each specific host is indicated and a minus sign (-) indicate that the fungus is associated with more than one host.



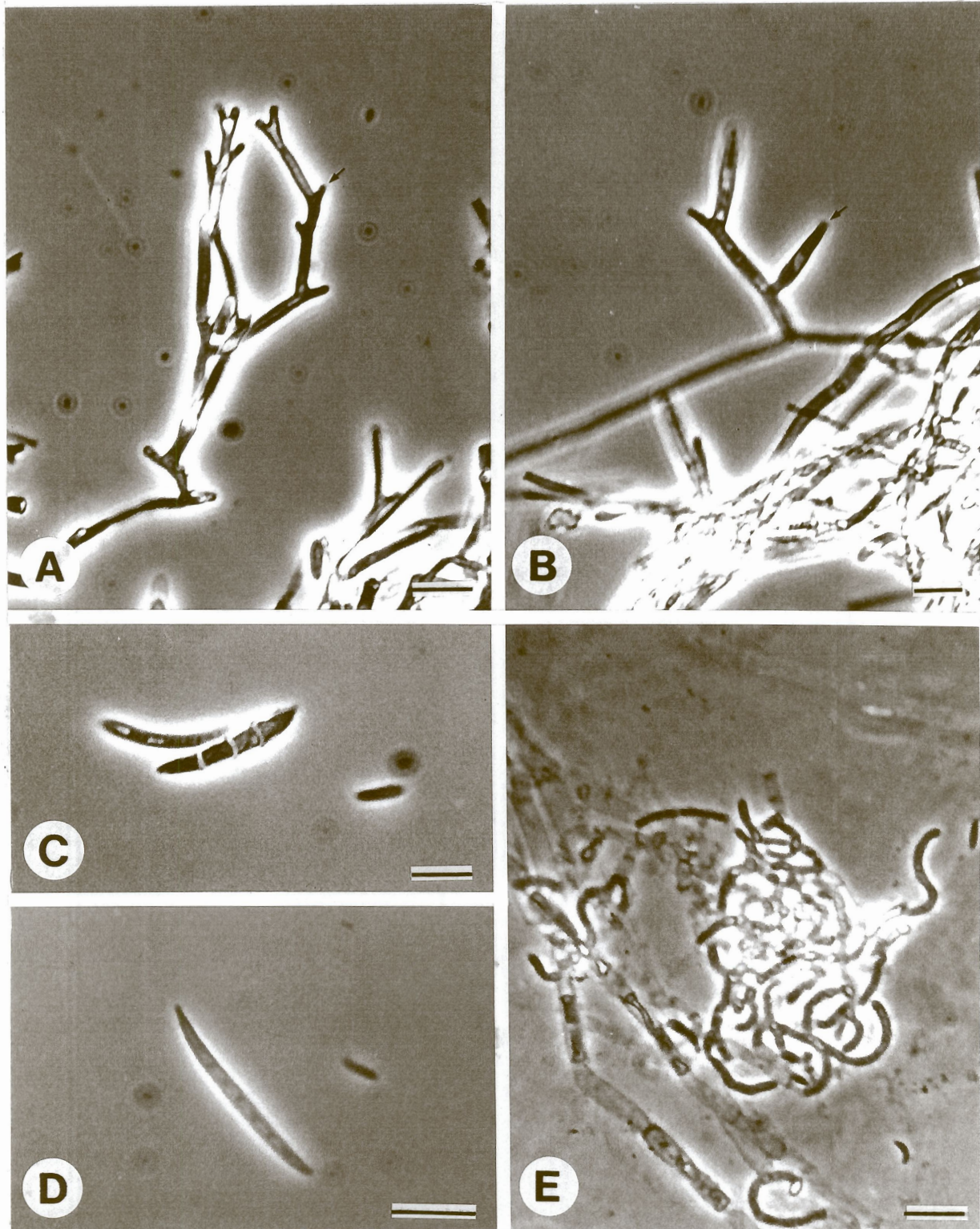

**Figure 1.** Three of the diagnostic morphological characters used in this study. The first is conidiophore branching patterns where **A** represents a branched conidiophore bearing polyphialides (arrow indicates an intercalary phialide) and **B** represents an unbranched conidiophore bearing two monophialides (arrow indicates the single conidiogenous opening of one of the monophialides). The second character is the number of macroconidial septa, where two groups are identified: 3-septate (**C**) and 5-septate (**D**) macroconidia. The third morphological character is sterile coiled hyphae (**E**). Scale bars = 10 $\mu$ m.

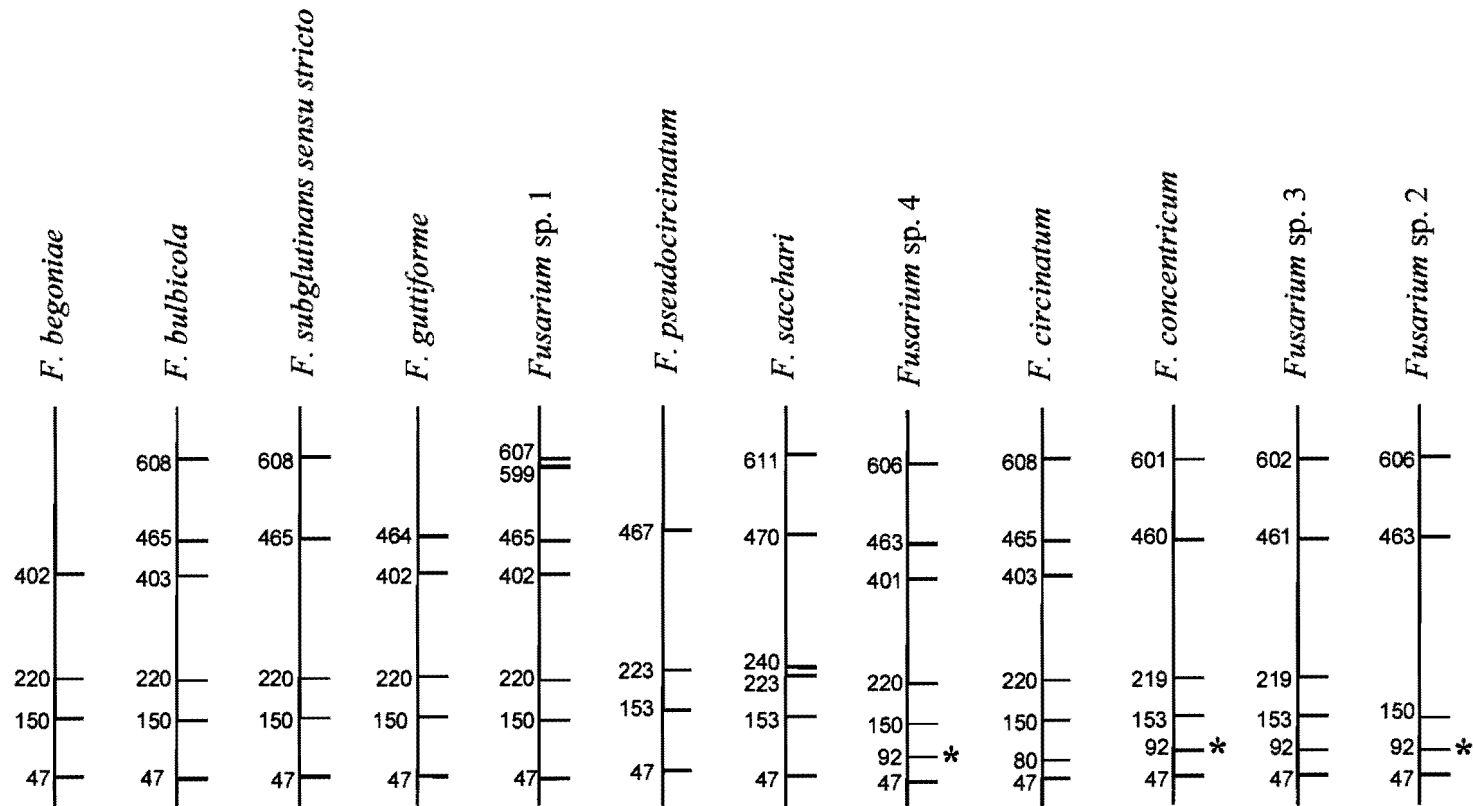

**Figure 2.** EF-1 $\alpha$  restriction maps for the 12 taxa representing *F. subglutinans sensu lato*, generated with Webcutter using the recognition sites for the enzymes *Mse*1, *Bgl*1, *Rsa*1 and *Sau*3A1. In each case ~640 base pairs of the EF-1 $\alpha$  gene are represented by a vertical line. The restriction sites are indicated as colored horizontal lines, with the restriction sites for *Mse*1 (red), *Rsa*1 (blue) and *Sau*3A1 (green) indicated in base pairs. The restriction site for the enzyme *Bgl*1 corresponds to the *Sau*3A1 site at position 92 in three of the taxa and are indicated with an asterisk (\*).



EF-1 $\alpha$ , calmodulin,  $\beta$ -tubulin  
and mtSSU; 2602 bp; 743  
steps; RI=0.79; CI=0.76

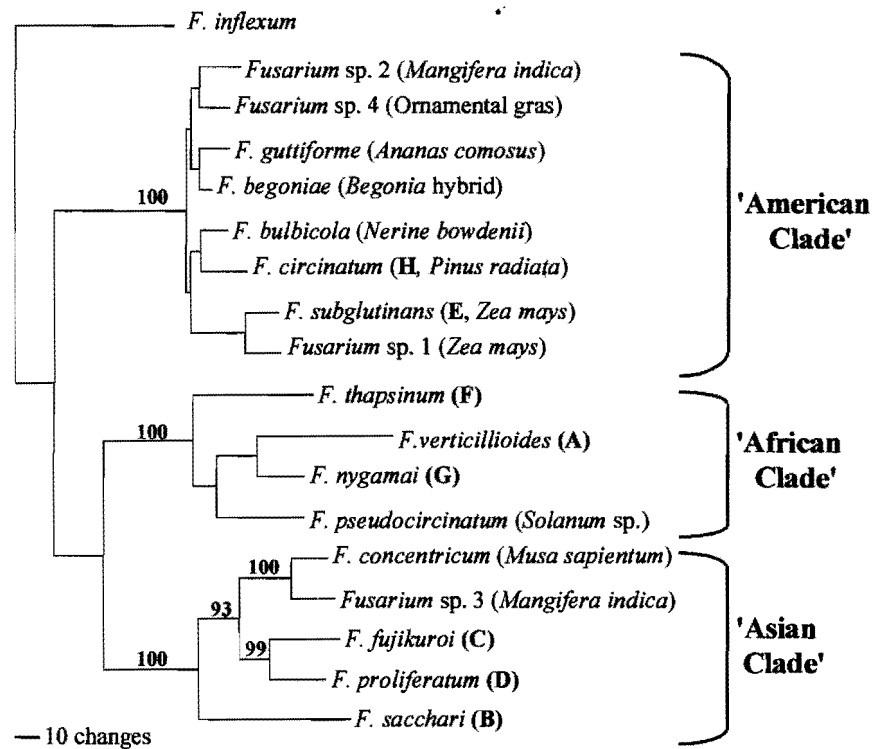

**Figure 3.** One of five most parsimonious trees generated from the combined sequence data sets for the four loci, mtSSU, calmodulin, EF-1 $\alpha$ , and  $\beta$ -tubulin. The host for each of the 12 species representing *F. subglutinans sensu lato* are indicated in parentheses. The *G. fujikuroi* mating populations A to H are indicated in bold letters. This tree is rooted to *F. inflexum* and bootstrap values are based on 1,000 replications. See O'Donnell et al. (28) for GenBank Accession numbers.



## SUMMARY

The primary goal of this project was to address different questions regarding the taxonomy and phylogeny of fungal isolates representing *Fusarium subglutinans sensu lato*, using protein-coding DNA sequences. In the introductory chapter, a review on the value of these sequences was presented. Special reference was made to the different evolutionary forces acting upon these sequences. The implication of these forces for the interpretation and inference of phylogenies was also considered.

*F. subglutinans* f. sp. *pini* is an important fungal disease in timber industries worldwide. The histone *H3* PCR-RFLP technique, reported in chapter two, has allowed rapid identification of this fungus and the technique has subsequently been used to diagnose numerous outbreaks of *F. subglutinans* f. sp. *pini*. Histone *H3* PCR-RFLPs also represents the first DNA-based method for identifying a fungal pathogen of importance to the South African forestry industry.

Identification of *Fusarium* isolates of opposite mating type, plays an integral part in applying the biological species concept and identifying new mating populations. These studies are greatly simplified by using the PCR-based technique developed in chapter three. This PCR-based method for determining whether isolates have *MAT-1* or *MAT-2* idiomorphs at their mating type loci, reduces the number of crosses necessary for these studies by more than 50%.

Mango is an important fruit crop in many parts of the world, where mango trees are threatened by the disease known as mango malformation. The study presented in chapter four showed that this disease is associated with two distinct *F. subglutinans sensu lato* species in South Africa. One of these constitutes a previously undescribed lineage. The second species was shown to be conspecific with the *Fusarium* species, known to cause mango malformation.

Currently, eight biological species are found in the *G. fujikuroi* complex, three of which display morphological characters typical of *F. subglutinans*. The possibility of a fourth mating population displaying these characters was investigated in chapter five. However, phylogenetic analyses using calmodulin and  $\beta$ -tubulin genes, showed that this fourth mating population forms part of the existing *G. fujikuroi* mating population E (*F. subglutinans sensu stricto*).

For classifying *Fusarium* spp. in the *G. fujikuroi* complex, the most accurate identifications are made using the phylogenetic species concept. This is especially true for species that are able to sexually interact across species boundaries. For example, the phylogenetic study presented in chapter six showed that one of the biological species of *G. fujikuroi* (mating population E) can be subdivided into two phylogenetic species.

Differentiating the different lineages representing *F. subglutinans sensu lato* is difficult



using conventional morphology-based classification systems. In the final chapter of this thesis, five morphological characters are identified for discriminating between the different species representing *F. subglutinans sensu lato*. A DNA-based identification system for these fungi is also presented in the form of restriction enzyme maps.

The fungi representing *F. subglutinans sensu lato* are economically important, because they are not only responsible for diseases on important crops, but also produce mycotoxins, thus posing a threat to human and animal health. These fungi have, therefore, been the focus of numerous studies, many of which dealt with their taxonomy. It is my hope that the research presented in this thesis will contribute significantly towards a better understanding of the biology and taxonomy of *F. subglutinans sensu lato* and the *G. fujikuroi* complex.

## OPSOMMING

Die hoofdoel van hierdie projek was om die taksonomie en filogenie van verskeie *Fusarium subglutinans sensu lato* isolate te bestudeer. Dit is gedoen deur gebruik te maak van die basis-paar-oopenvolgings van gene wat proteiene enkodeer. Die inleidende hoofstuk van hierdie tesis is dus 'n literatuur studie, wat die gebruik van hierdie gene in die taksonomie en filogenie van fungi hersien. Hier is veral klem gelê op die evolusionêre kragte wat bygedra het tot die vorming van hierdie gene, asook die evolusionêre kragte wat tans daarop inwerk. Hoe hierdie kragte die interpretasie en generasie van filogenië beïnvloed, is ook bespreek.

Bosboubedrywe wêreldwyd word ernstig bedreig deur die patoogen *F. subglutinans* f. sp. *pini*. Hierdie fungus veroorsaak die sogenaamde siekte 'pitch canker' op volwasse *Pinus* spp. asook verrotting van die wortels van denne saailinge. Hierdie patoogen kan egter vinnig en effektief geïdentifiseer word deur gebruik te maak van die histoon *H3* PCR-RFLP tegniek, wat in die tweede hoofstuk van hierdie tesis ontwikkel is. Sedertdien is verskeie uitbrake van 'pitch canker' korrek gediagnoseer en maatreëls betyds daargestel om die siekte te beheer. Verder verteenwoordig die histoon *H3* PCR-RFLP tegniek, die eerste DNA-gebaseerde metode om 'n belangrike swamagtige patoogen te identifiseer in die Suid Afrikaanse bosboubedryf.

Die identifisering van isolate met teenoorgestelde geslagstipes, speel 'n belangrike rol tydens die toepassing van die biologiese spesiekonsep, asook by die identifikasie van nuwe biologiese spesies. Hierdie studies kan egter baie vereenvoudig word deur gebruik te maak van die PCR-gebaseerde tegniek wat in hoofstuk drie ontwikkel is. Met hierdie tegniek kan die geslagstipes van isolate bepaal word sonder om kruisings te doen. Hierdie tegniek verminder sodoende die hoeveelheid kruisings wat gewoonlik gedoen word met meer as 50%.

Mango is 'n belangrike vrugtegewas en mangobome word bedreig deur die sogenaamde siekte 'mango malformation'. In hoofstuk vyf word daar gewys dat hierdie siekte in Suid Afrika, geassosieerd is met twee *F. subglutinans sensu lato* spesies. Een van hierdie spesies verteenwoordig 'n nuwe, voorheen onbeskryfde spesie. Die tweede een behoort aan dieselfde *Fusarium* spesie as die wat die siekte 'mango malformation' veroorsaak.

Tans is daar agt biologiese spesies in die *G. fujikuroi* kompleks, waarvan drie gekarakteriseer word deur morfologies eienskappe, tipies aan *F. subglutinans*. Die moontlikheid van die bestaan van 'n vierde biologiese spesie met hierdie eienskappe, is in hoofstuk vyf ondersoek. Filogenetiese analyses met kalmodulien en  $\beta$ -tubulien DNA basis-oopenvolgings, het egter gewys dat hierdie vierde biologiese spesie in der waarheid deel is van die bestaande biologiese spesie E (*F. subglutinans sensu stricto*).

Vir die klassifikasie van spesies in die *G. fujikuroi* kompleks word die akkuraatste

identifikasies verkry, wanneer die filogenetiese spesiekonsep gebruik word. Dit is veral waar, wanneer verskillende spesies oor die 'spesiegrens' geslagtelik met mekaar kan reageer. So, byvoorbeeld verteenwoordig die biologiese spesie E eintlik twee diskrete filogenetiese spesies en nie net een monofiletiese eenheid nie. Hierdie werk is omvat in die sesde hoofstuk van hierdie tesis.

Onderskeiding tussen *F. subglutinans sensu lato* spesies, met behulp van konvensionele morfologiese karakters, is moeilik. In die laaste hoofstuk van hierdie tesis word vyf onderskeidende morfologiese karakters beskryf. Addisioneel, is 'n DNA-gebaseerde identifikasie sisteem vir die fungi wat *F. subglutinans sensu lato* verteenwoordig, ook ontwikkel.

Die meeste fungi wat *F. subglutinans sensu lato* verteenwoordig is ekonomies belangrik. Hulle is verantwoordelik vir siektes op belangrike gewasse, maar kan ook toksiese sekondêre metaboliete produseer en sodoende mense en diere benadeel. Hierdie is dus 'n goed bestudeerde groep fungi, waar aspekte aangaande hul filogenie en taksonomie baie aandag geniet het. Ek hoop dat die navorsing voorgelê in hierdie tesis sal bydra to ons kennis van die biologie en taksonomie van *F. subglutinans sensu lato* en die *G. fujikuroi* spesie kompleks.



## APPENDIX 1

Aligned histone *H3* DNA sequences for selected *Fusarium* strains in the *Gibberella fujikuroi* complex. These sequences were used to differentiate the pitch canker fungus, *F. subglutinans* f. sp. *pini* [*G. fujikuroi* mating population H (MP-H)], from other fungi in this complex (Steenkamp et al. 1999, Appl. Environ. Microbiol. 65:3401-3406; Chapter 2 of this thesis). Nucleotides similar to those of *F. oxysporum* are indicated as dots, whereas nucleotide deletions are indicated by vertical lines (-).

	10	20	30	40	50	60
<i>F. oxysporum</i> (MRC6212)	GGTGGCAAGG	CCCCTCGCAA	GCAGCTCGCT	TCCAAGGCCG	GTAAGTCTTC	-----ACCGC
<b>Host = Pineapple</b>						
<i>F. subglutinans</i> (MRC6783)	.....	.....	.....	.....T	.....	-----
<i>F. subglutinans</i> (MRC6784)	.....	.....	.....	.....T	.....	-----
<i>F. subglutinans</i> (MRC6785)	.....	.....	.....	.....T	.....	-----
<i>F. subglutinans</i> (MRC6782)	.....	.....	.....	.....T	.....	-----
<b>MP-E; Host = Maize</b>						
<i>F. subglutinans</i> (MRC1077)	.....	.....	.....	.....T	.....A	-----
<i>F. subglutinans</i> (MRC1084)	.....	.....	.....	.....T	.....A	-----
<i>F. subglutinans</i> (MRC756)	.....	.....	.....	.....T	.....A	-----
<i>F. subglutinans</i> (MRC837)	.....	.....	.....	.....T	.....A	-----
<i>F. subglutinans</i> (MRC714)	.....	.....	.....	.....T	.....A	-----
<i>F. subglutinans</i> (MRC620)	.....	.....	.....	.....T	.....A	-----
<i>F. subglutinans</i> (MRC115)	.....	.....	.....	.....T	.....A	-----
<i>F. subglutinans</i> (MRC6512)	.....	.....	.....	.....T	.....A	-----
<i>F. subglutinans</i> (MRC6483)	.....	.....	.....	.....T	.....A	-----
<b>MP-H; Host = Pine</b>						
<i>F. subglutinans</i> (MRC6209)	.....	.....	.....	.....T	.....	-----
<i>F. subglutinans</i> (MRC6211)	.....	.....	.....	.....T	.....	-----
<i>F. subglutinans</i> (MRC7440)	.....	.....	.....	.....T	.....	-----
<i>F. subglutinans</i> (MRC6213)	.....	.....	.....	.....T	.....	-----
<i>F. subglutinans</i> (MRC6228)	.....	.....	.....	.....T	.....	-----
<i>F. subglutinans</i> (MRC7439)	.....	.....	.....	.....T	.....	-----
<i>F. subglutinans</i> (MRC7438)	.....	.....	.....	.....T	.....	-----
<i>F. subglutinans</i> (MRC7437)	.....	.....	.....	.....T	.....	-----
<b>Host = mango</b>						
<i>F. subglutinans</i> (MRC7038)	.....	.....	.....C	.....T	.....	-----
<i>F. subglutinans</i> (MRC7037)	.....	.....	.....C	.....T	.....	-----
<i>F. subglutinans</i> (MRC7034)	.....	.....	.....C	.....T	.....	-----
<i>F. subglutinans</i> (MRC2730)	.....	.....	.....C	.....T	.....	-----
<i>F. subglutinans</i> (MRC7035)	.....	.....	.....C	.....T	.....	-----
<i>F. subglutinans</i> (MRC3479)	.....	.....	.....C	.....T	.....	-----
<i>F. subglutinans</i> (MRC3477)	.....	.....	.....C	.....T	.....	-----
<i>F. subglutinans</i> (MRC3478)	.....	.....	.....C	.....T	.....	-----
<b>MP-B; Host = Sugarcane</b>						
<i>F. subglutinans</i> (MRC6525)	.....	.....G	.....C	.....T	.....T	-----
<i>F. subglutinans</i> (MRC6524)	.....	.....G	.....C	.....T	.....T	-----
<b>MP-G</b>						
<i>F. nygamai</i> (MRC7548)	.....	.....	.....	.....T	.....	---TC
<i>F. nygamai</i> (MRC7549)	.....	.....	.....	.....T	.....	---TC
<b>MP-F</b>						
<i>F. thapsinum</i> (MRC6537)	.....	.....	.....	.....A	.....T	---TC
<i>F. thapsinum</i> (MRC6536)	.....	.....	.....	.....A	.....T	---TC
<b>MP-A</b>						
<i>F. moniliiforme</i> (MRC6155)	.....	.....	.....	.....T	.....	---TC
<i>F. moniliiforme</i> (MRC6191)	.....	.....	.....	.....T	.....	---TC
<b>MP-D</b>						
<i>F. proliferatum</i> (MRC6569)	.....	.....	.....T	.....T	.....T	-----
<i>F. proliferatum</i> (MRC6568)	.....	.....	.....T	.....T	.....T	-----
<b>MP-C</b>						
<i>F. proliferatum</i> (MRC6571)	.....	.....	.....C	.....T	.....T	----C...C
<i>F. proliferatum</i> (MRC6570)	.....	.....	.....C	.....T	.....T	----C...C





	70	80	90	100	110	120
<i>F. oxysporum</i> (MRC6212)	GACTTT-ATC	TC-GACGCGA	CA-CACGTCT	T-GATAC-AT	A-AAAAACGC	C-ATAACTAA
<b>Host = Pineapple</b>						
<i>F. subglutinans</i> (MRC6783)	.....-C.A.	...-.....	...-G.....	..-G.C.-..	C-.....A.	...-C.....
<i>F. subglutinans</i> (MRC6784)	.....-C.A.	...-.....	...-G.....	..-G.C.-..	C-.....A.	...-C.....
<i>F. subglutinans</i> (MRC6785)	.....-C.A.	...-.....	...-G.....	..-G.C.-..	C-.....A.	...-C.....
<i>F. subglutinans</i> (MRC6782)	.....-C.A.	...-.....	...-G.....	..-G.C.-..	C-.....A.	...-C.....
<b>MP-E; Host = Maize</b>						
<i>F. subglutinans</i> (MRC1077)	.....-G.A.	...-.....	...-G.....	..-G.C.-..	C-.....A.	...-C.....
<i>F. subglutinans</i> (MRC1084)	.....-G.A.	...-.....	...-G.....	..-G.C.-..	C-.....A.	...-C.....
<i>F. subglutinans</i> (MRC756)	.....-G.A.	...-.....	...-G.....	..-G.C.-..	C-.....A.	...-C.....
<i>F. subglutinans</i> (MRC837)	.....-G.A.	...-.....	...-G.....	..-G.C.-..	C-.....A.	...-C.....
<i>F. subglutinans</i> (MRC714)	.....-G.A.	...-.....	...-G.....	..-G.C.-..	C-.....A.	...-C.....
<i>F. subglutinans</i> (MRC620)	.....-G.A.	...-.....	...-G.....	..-G.C.-..	C-.....A.	...-C.....
<i>F. subglutinans</i> (MRC115)	.....-G.A.	...-.....	...-G.....	..-G.C.-..	C-.....A.	...-C.....
<i>F. subglutinans</i> (MRC6512)	.....-G.A.	...-.....	...-G.....	..-G.C.-..	C-.....A.	...-C.....
<i>F. subglutinans</i> (MRC6483)	.....-G.A.	...-.....	...-G.....	..-G.C.-..	C-.....A.	...-C.....
<b>MP-H; Host = Pine</b>						
<i>F. subglutinans</i> (MRC6209)	.....-C.A.	...-.....	...-G.....	..-G.C.-..	C-.....A.	...-C.....
<i>F. subglutinans</i> (MRC6211)	.....-C.A.	...-.....	...-G.....	..-G.C.-..	C-.....A.	...-C.....
<i>F. subglutinans</i> (MRC7440)	.....-C.A.	...-.....	...-G.....	..-G.C.-..	C-.....A.	...-C.....
<i>F. subglutinans</i> (MRC6213)	.....-C.A.	...-.....	...-G.....	..-G.C.-..	C-.....A.	...-C.....
<i>F. subglutinans</i> (MRC6228)	.....-C.A.	...-.....	...-G.....	..-G.C.-..	C-.....A.	...-C.....
<i>F. subglutinans</i> (MRC7439)	.....-C.A.	...-.....	...-G.....	..-G.C.-..	C-.....A.	...-C.....
<i>F. subglutinans</i> (MRC7438)	.....-C.A.	...-.....	...-G.....	..-G.C.-..	C-.....A.	...-C.....
<i>F. subglutinans</i> (MRC7437)	.....-C.A.	...-.....	...-G.....	..-G.C.-..	C-.....A.	...-C.....
<b>Host = mango</b>						
<i>F. subglutinans</i> (MRC7038)	....C-C.A.	...-.....	...-G.....	--G.T-A..	C-.....AT	-GG.C.....
<i>F. subglutinans</i> (MRC7037)	....C-C.A.	...-.....	...-G.....	--G.T-A..	C-.....AT	-GG.C.....
<i>F. subglutinans</i> (MRC7034)	....C-C.A.	...-.....	...-G.....	--G.T-A..	C-.....AT	-GG.C.....
<i>F. subglutinans</i> (MRC2730)	....C-C.A.	...-.....	...-G.....	--G.T-A..	C-.....AT	-GG.C.....
<i>F. subglutinans</i> (MRC7035)	....C-C.A.	...-.....	...-G.....	--G.T-A..	C-.....AT	-GG.C.....
<i>F. subglutinans</i> (MRC3479)	....C-C.A.	...-.....	...-G.....	--G.T-A..	C-.....AT	-GG.C.....
<i>F. subglutinans</i> (MRC3477)	....C-C.A.	...-.....	...-G.....	--G.T-A..	C-.....AT	-GG.C.....
<i>F. subglutinans</i> (MRC3478)	....C-C.A.	...-.....	...-G.....	--G.T-A..	C-.....AT	-GG.C.....
<b>MP-B; Host = Sugarcane</b>						
<i>F. subglutinans</i> (MRC6525)	....C-C.A.	...-.....	...-G.....	---G.T.A..	CC.....AT	T-..C..C-
<i>F. subglutinans</i> (MRC6524)	....C-C.A.	...-.....	...-G.....	---G.T.A..	CC.....AT	T-..C..C-
<b>MP-G</b>						
<i>F. nygamai</i> (MRC7548)	.....-C.A.	...-.....	...-G.....	..-G.C.-..	C-.....G.AT	...-C.....
<i>F. nygamai</i> (MRC7549)	.....-C.A.	...-.....	...-G.....	..-G.C.-..	C-.....G.AT	...-C.....
<b>MP-F</b>						
<i>F. thapsinum</i> (MRC6537)	.....-G.A.	C-...T...	...-G.....	..-GGC.-..	C-.....AT	T-.CC.....
<i>F. thapsinum</i> (MRC6536)	.....-G.A.	C-...T...	...-G.....	..-GGC.-..	C-.....AT	T-.CC.....
<b>MP-A</b>						
<i>F. moniliforme</i> (MRC6155)	.....-C.A.	CT-.....	T-..G.....	C-..G.T.-..	C-.....G.AT	..-G.C.....
<i>F. moniliforme</i> (MRC6191)	.....-C.A.	CT-.....	T-..G.....	C-..G.T.-..	C-.....G.AT	..-G.C.....
<b>MP-D</b>						
<i>F. proliferatum</i> (MRC6569)	.....-C.A.	...-.....	TGT.G.....	-G.G.--A.-	CC.....AT	-G.CC.....
<i>F. proliferatum</i> (MRC6568)	.....-C.A.	...-.....	TGT.G.....	-G.G.--A.-	CC.....AT	-G.CC.....
<b>MP-C</b>						
<i>F. proliferatum</i> (MRC6571)	.....-C.A.	...-.....	...-G.....	-G.G.--A.-	CC.....AT	-G.CC.....
<i>F. proliferatum</i> (MRC6570)	.....-C.A.	...-.....	...-G.....	-G.G.--A.-	CC.....AT	-G.CC.....



	130	140	150	160	170	180
<i>F. oxysporum</i> (MRC6212)	CA-TCATCAC	CAACAGCCCG	CAAGTCCGCC	CCCTCTACCG	GAGGTGTCAA	GAAGCCTCAC
<b>Host = Pineapple</b>						
<i>F. subglutinans</i> (MRC6783)	.T-.G....	.....T..	.....	..A..C....	.....	.....
<i>F. subglutinans</i> (MRC6784)	.T-.G....	.....T..	.....	..A..C....	.....	.....
<i>F. subglutinans</i> (MRC6785)	.T-.G....	.....T..	.....	..A..C....	.....	.....
<i>F. subglutinans</i> (MRC6782)	.T-.G....	.....T..	.....	..A..C....	.....	.....
<b>MP-E; Host = Maize</b>						
<i>F. subglutinans</i> (MRC1077)	.T-...C...	.....	.....	..A..C....	.....	.....
<i>F. subglutinans</i> (MRC1084)	.T-...C...	.....	.....	..A..C....	.....	.....
<i>F. subglutinans</i> (MRC756)	.T-...C...	.....	.....	..A..C....	.....	.....
<i>F. subglutinans</i> (MRC837)	.T-...C...	.....	.....	..A..C....	.....	.....
<i>F. subglutinans</i> (MRC714)	.T-...C...	.....	.....	..A..C....	.....	.....
<i>F. subglutinans</i> (MRC620)	.T-...C...	.....	.....	..A..C....	.....	.....
<i>F. subglutinans</i> (MRC115)	.T-...C...	.....	.....	..A..C....	.....	.....
<i>F. subglutinans</i> (MRC6512)	.T-...C...	.....	.....	..A..C....	.....	.....
<i>F. subglutinans</i> (MRC6483)	.T-...C...	.....	.....	..A..C....	.....	.....
<b>MP-H; Host = Pine</b>						
<i>F. subglutinans</i> (MRC6209)	.T-.....	.....	.....	..A..C....	.....	.....
<i>F. subglutinans</i> (MRC6211)	.T-.....	.....	.....	..A..C....	.....	.....
<i>F. subglutinans</i> (MRC7440)	.T-.....	.....	.....	..A..C....	.....	.....
<i>F. subglutinans</i> (MRC6213)	.T-.....	.....	.....	..A..C....	.....	.....
<i>F. subglutinans</i> (MRC6228)	.T-.....	.....	.....	..A..C....	.....	.....
<i>F. subglutinans</i> (MRC7439)	.T-.....	.....	.....	..A..C....	.....	.....
<i>F. subglutinans</i> (MRC7438)	.T-.....	.....	.....	..A..C....	.....	.....
<i>F. subglutinans</i> (MRC7437)	.T-.....	.....	.....	..A..C....	.....	.....
<b>Host = mango</b>						
<i>F. subglutinans</i> (MRC7038)	.T-.....	.....	.....	.....	.....	.....
<i>F. subglutinans</i> (MRC7037)	.T-.....	.....	.....	.....	.....	.....
<i>F. subglutinans</i> (MRC7034)	.T-.....	.....	.....	.....	.....	.....
<i>F. subglutinans</i> (MRC2730)	.T-.....	.....	.....	.....	.....	.....
<i>F. subglutinans</i> (MRC7035)	.T-.....	.....	.....	.....	.....	.....
<i>F. subglutinans</i> (MRC3479)	.T-.....	.....	.....	.....	.....	.....
<i>F. subglutinans</i> (MRC3477)	.T-.....	.....	.....	.....	.....	.....
<i>F. subglutinans</i> (MRC3478)	.T-.....	.....	.....	.....	.....	.....
<b>MP-B; Host = Sugarcane</b>						
<i>F. subglutinans</i> (MRC6525)	.TGA....GT -	.....	A.....	.....	.....	.....
<i>F. subglutinans</i> (MRC6524)	.TGA....GT -	.....	A.....	.....	.....	.....
<b>MP-G</b>						
<i>F. nygamai</i> (MRC7548)	.T-.....	.....	.....	.....C....	.....	.....
<i>F. nygamai</i> (MRC7549)	.T-.....	.....	.....	.....C....	.....	.....
<b>MPF</b>						
<i>F. thapsinum</i> (MRC6537)	.TT--..--..	.....T..	.....	.....	.....	.....
<i>F. thapsinum</i> (MRC6536)	.TT--..--..	.....T..	.....	.....	.....	.....
<b>MP-A</b>						
<i>F. moniliforme</i> (MRC6155)	.TT-......	.....T..	.....	.....C....	.....	.....
<i>F. moniliforme</i> (MRC6191)	.TT-......	.....T..	.....	.....C....	.....	.....
<b>MP-D</b>						
<i>F. proliferatum</i> (MRC6569)	.T-.....	.....	.....	.....	.....	.....
<i>F. proliferatum</i> (MRC6568)	.T-.....	.....	.....	.....	.....	.....
<b>MPC</b>						
<i>F. proliferatum</i> (MRC6571)	.T-.....	.....	.....	.....	.....	.....
<i>F. proliferatum</i> (MRC6570)	.T-.....	.....	.....	.....	.....	.....



	190	200	210	220	230	240
<i>F.oxysporum</i> (MRC6212)	CGCTATAAGC	CTGGTACCGT	CGCTCTCCGT	GAGATTTCGAC	GATACCAGAA	GTCGACCGAG
<b>Host = Pineapple</b>						
<i>F.subglutinans</i> (MRC6783)	.....C.....	.....	.....	.....	.....	.....
<i>F.subglutinans</i> (MRC6784)	.....C.....	.....	.....	.....	.....	.....
<i>F.subglutinans</i> (MRC6785)	.....C.....	.....	.....	.....	.....	.....
<i>F.subglutinans</i> (MRC6782)	.....C.....	.....	.....	.....	.....	.....
<b>MP-E; Host = Maize</b>						
<i>F.subglutinans</i> (MRC1077)	.....C.....	.....	T.....	.....	.....	.....
<i>F.subglutinans</i> (MRC1084)	.....C.....	.....	T.....	.....	.....	.....
<i>F.subglutinans</i> (MRC756)	.....C.....	.....	T.....	.....	.....	.....
<i>F.subglutinans</i> (MRC837)	.....C.....	.....	T.....	.....	.....	.....
<i>F.subglutinans</i> (MRC714)	.....C.....	.....	T.....	.....	.....	.....
<i>F.subglutinans</i> (MRC620)	.....C.....	.....	T.....	.....	.....	.....
<i>F.subglutinans</i> (MRC115)	.....C.....	.....	T.....	.....	.....	.....
<i>F.subglutinans</i> (MRC6512)	.....C.....	.....	T.....	.....	.....	.....
<i>F.subglutinans</i> (MRC6483)	.....C.....	.....	T.....	.....	.....	.....
<b>MP-H; Host = Pine</b>						
<i>F.subglutinans</i> (MRC6209)	.....C.....	.....	.....	.....	.....	T.....
<i>F.subglutinans</i> (MRC6211)	.....C.....	.....	.....	.....	.....	T.....
<i>F.subglutinans</i> (MRC7440)	.....C.....	.....	.....	.....	.....	T.....
<i>F.subglutinans</i> (MRC6213)	.....C.....	.....	.....	.....	.....	T.....
<i>F.subglutinans</i> (MRC6228)	.....C.....	.....	.....	.....	.....	T.....
<i>F.subglutinans</i> (MRC7439)	.....C.....	.....	.....	.....	.....	T.....
<i>F.subglutinans</i> (MRC7438)	.....C.....	.....	.....	.....	.....	T.....
<i>F.subglutinans</i> (MRC7437)	.....C.....	.....	.....	.....	.....	T.....
<b>Host = mango</b>						
<i>F.subglutinans</i> (MRC7038)	.....C.....	.C.....	.....	.....	.....	T.....
<i>F.subglutinans</i> (MRC7037)	.....C.....	.C.....	.....	.....	.....	T.....
<i>F.subglutinans</i> (MRC7034)	.....C.....	.C.....	.....	.....	.....	T.....
<i>F.subglutinans</i> (MRC2730)	.....C.....	.C.....	.....	.....	.....	T.....
<i>F.subglutinans</i> (MRC7035)	.....C.....	.C.....	.....	.....	.....	T.....
<i>F.subglutinans</i> (MRC3479)	.....C.....	.C.....	.....	.....	.....	T.....
<i>F.subglutinans</i> (MRC3477)	.....C.....	.C.....	.....	.....	.....	T.....
<i>F.subglutinans</i> (MRC3478)	.....C.....	.C.....	.....	.....	.....	T.....
<b>MP-B; Host = Sugarcane</b>						
<i>F.subglutinans</i> (MRC6525)	.....C.....	.C.....	.....	.....	.....	T.....
<i>F.subglutinans</i> (MRC6524)	.....C.....	.C.....	.....	.....	.....	T.....
<b>MP-G</b>						
<i>F.nygamai</i> (MRC7548)	.....C.....	.C.....	.....	.....	.....	T.....
<i>F.nygamai</i> (MRC7549)	.....C.....	.C.....	.....	.....	.....	T.....
<b>MP-F</b>						
<i>F.thapsinum</i> (MRC6537)	.....C.....	.C.....	.....	.....	.....	.....
<i>F.thapsinum</i> (MRC6536)	.....C.....	.C.....	.....	.....	.....	.....
<b>MP-A</b>						
<i>F.moniliforme</i> (MRC6155)	.....C.....	.C.....	.....	.....	.....	T.....
<i>F.moniliforme</i> (MRC6191)	.....C.....	.C.....	.....	.....	.....	T.....
<b>MPD</b>						
<i>F.proliferatum</i> (MRC6569)	.....C.....	.C.....	.....	.....	.....	.....
<i>F.proliferatum</i> (MRC6568)	.....C.....	.C.....	.....	.....	.....	.....
<b>MP-C</b>						
<i>F.proliferatum</i> (MRC6571)	.....C.....	.C.....	.....	.....	.....	.....
<i>F.proliferatum</i> (MRC6570)	.....C.....	.C.....	.....	.....	.....	.....



	250	260	270	280	290	300
<i>F. oxysporum</i> (MRC6212)	CTCCTCATCC	GAAAGCTCCC	CTTCCAGCGT	CTGGTGAGCA	CCAC---CAA	TATACATCAA
<b>Host = Pineapple</b>						
<i>F. subglutinans</i> (MRC6783)	.....	.....	.....	.....A....	T...---.TG	.-.....
<i>F. subglutinans</i> (MRC6784)	.....	.....	.....	.....A....	T...---.TG	.-.....
<i>F. subglutinans</i> (MRC6785)	.....	.....	.....	.....A....	T...---.TG	.-.....
<i>F. subglutinans</i> (MRC6782)	.....	.....	.....	.....A....	T...---.TG	.-.....
<b>MP-E; Host = Maize</b>						
<i>F. subglutinans</i> (MRC1077)	.....	.....	.....C	.....A....	.....---.TG	C-.....
<i>F. subglutinans</i> (MRC1084)	.....	.....	.....C	.....A....	.....---.TG	C-.....
<i>F. subglutinans</i> (MRC756)	.....	.....	.....C	.....A....	.....---.TG	C-.....
<i>F. subglutinans</i> (MRC837)	.....	.....	.....C	.....A....	.....---.TG	C-.....
<i>F. subglutinans</i> (MRC714)	.....	.....	.....C	.....A....	.....---.TG	C-.....
<i>F. subglutinans</i> (MRC620)	.....	.....	.....C	.....A....	.....---.TG	C-.....
<i>F. subglutinans</i> (MRC115)	.....	.....	.....C	.....A....	.....---.TG	C-.....
<i>F. subglutinans</i> (MRC6512)	.....	.....	.....C	.....A....	.....---.TG	C-.....
<i>F. subglutinans</i> (MRC6483)	.....	.....	.....C	.....A....	.....---.TG	C-.....
<b>MP-H; Host = Pine</b>						
<i>F. subglutinans</i> (MRC6209)	.....	.....	.....C	.....A....	T...---.TG	C-.....
<i>F. subglutinans</i> (MRC6211)	.....	.....	.....C	.....A....	T...---.TG	C-.....
<i>F. subglutinans</i> (MRC7440)	.....	.....	.....C	.....A....	T...---.TG	C-.....
<i>F. subglutinans</i> (MRC6213)	.....	.....	.....C	.....A....	T...---.TG	C-.....
<i>F. subglutinans</i> (MRC6228)	.....	.....	.....C	.....A....	T...---.TG	C-.....
<i>F. subglutinans</i> (MRC7439)	.....	.....	.....C	.....A....	T...---.TG	C-.....
<i>F. subglutinans</i> (MRC7438)	.....	.....	.....C	.....A....	T...---.TG	C-.....
<i>F. subglutinans</i> (MRC7437)	.....	.....	.....C	.....A....	T...---.TG	C-.....
<b>Host = mango</b>						
<i>F. subglutinans</i> (MRC7038)	.....	.....	.....	.....A....	T...---.TG	.-A...C.--
<i>F. subglutinans</i> (MRC7037)	.....	.....	.....	.....A....	T...---.TG	.-A...C.--
<i>F. subglutinans</i> (MRC7034)	.....	.....	.....	.....A....	T...---.TG	.-A...C.--
<i>F. subglutinans</i> (MRC2730)	.....	.....	.....	.....A....	T...---.TG	.-A...C.--
<i>F. subglutinans</i> (MRC7035)	.....	.....	.....	.....A....	T...---.TG	.-A...C.--
<i>F. subglutinans</i> (MRC3479)	.....	.....	.....	.....A....	T...---.TG	.-A...C.--
<i>F. subglutinans</i> (MRC3477)	.....	.....	.....	.....A....	T...---.TG	.-A...C.--
<i>F. subglutinans</i> (MRC3478)	.....	.....	.....	.....A....	T...---.TG	.-A...C.--
<b>MP-B; Host = Sugarcane</b>						
<i>F. subglutinans</i> (MRC6525)	.....	.....	.....C	.....A....	TT..-TT.--	C-....CT--
<i>F. subglutinans</i> (MRC6524)	.....	.....	.....C	.....A....	TT..-TT.--	C-....CT--
<b>MP-G</b>						
<i>F. nygamai</i> (MRC7548)	.....	.....	.....	.....A...G	T...---.TG	C-.....G.
<i>F. nygamai</i> (MRC7549)	.....	.....	.....	.....A...G	T...---.TG	C-.....G.
<b>MP-F</b>						
<i>F. thapsinum</i> (MRC6537)	.....	.....	.....	.....A...G	...ATA---	C-.....
<i>F. thapsinum</i> (MRC6536)	.....	.....	.....	.....A...G	...ATA---	C-.....
<b>MP-A</b>						
<i>F. moniliiforme</i> (MRC6155)	.....T.	.....	.....	.....A...G	.....---.TG	C-.T.....
<i>F. moniliiforme</i> (MRC6191)	.....T.	.....	.....	.....A...G	.....---.TG	C-.T.....
<b>MP-D</b>						
<i>F. proliferatum</i> (MRC6569)	.....	.....	.....	.....A....	T...---.TG	C-.....T-C
<i>F. proliferatum</i> (MRC6568)	.....	.....	.....	.....A....	T...---.TG	C-.....T-C
<b>MP-C</b>						
<i>F. proliferatum</i> (MRC6571)	.....	.....	.....	.....A....	T...---.TG	C-.....T-C
<i>F. proliferatum</i> (MRC6570)	.....	.....	.....	.....A....	T...---.TG	C-.....T-C





	310	320	330	340	350	360
<i>F.oxysporum</i> (MRC6212)	--TCAACA-C	TTGACAT-AT	ACTAACATGA	GACAAACAGG	TTCGTGAGAT	TGCCCAGGAC
<b>Host = Pineapple</b>						
<i>F.subglutinans</i> (MRC6783)	--C..C-.G.	C.....-C..	.....T..TC	.....	.C..C.....	.....
<i>F.subglutinans</i> (MRC6784)	--C..C-.G.	C.....-C..	.....T..TC	.....	.C..C.....	.....
<i>F.subglutinans</i> (MRC6785)	--C..C-.G.	C.....-C..	.....T..TC	.....	.C..C.....	.....
<i>F.subglutinans</i> (MRC6782)	--C..C-.G.	C.....-C..	.....T..TC	.....	.C..C.....	.....
<b>MP-E; Host = Maize</b>						
<i>F.subglutinans</i> (MRC1077)	--C.GC-.G.	C.....-C..	.....TT	.....	.C..C.....	.....
<i>F.subglutinans</i> (MRC1084)	--C.GC-.G.	C.....-C..	.....TT	.....	.C..C.....	.....
<i>F.subglutinans</i> (MRC756)	--C.GC-.G.	C.....-C..	.....TT	.....	.C..C.....	.....
<i>F.subglutinans</i> (MRC837)	--C.GC-.G.	C.....-C..	.....TT	.....	.C..C.....	.....
<i>F.subglutinans</i> (MRC714)	--C..C-.G.	C.....-C..	.....TT	.....	.C..C.....	.....
<i>F.subglutinans</i> (MRC620)	--C.GC-.G.	C.....-C..	.....TT	.....	.C..C.....	.....
<i>F.subglutinans</i> (MRC115)	--C..C-.G.	C.....-C..	.....TT	.....	.C..C.....	.....
<i>F.subglutinans</i> (MRC6512)	--C..C-.G.	C.....-C..	.....TT	.....	.C..C.....	.....
<i>F.subglutinans</i> (MRC6483)	--C..C-.G.	C.....-C..	.....TT	.....	.C..C.....	.....
<b>MP-H; Host = Pine</b>						
<i>F.subglutinans</i> (MRC6209)	--C..C-.G.	C.....-C..	.....TT	.....	.C..C.....	.....
<i>F.subglutinans</i> (MRC6211)	--C..C-.G.	C.....-C..	.....TT	.....	.C..C.....	.....
<i>F.subglutinans</i> (MRC7440)	--C..C-.G.	C.....-C..	.....TT	.....	.C..C.....	.....
<i>F.subglutinans</i> (MRC6213)	--C..C-.G.	C.....-C..	.....TT	.....	.C..C.....	.....
<i>F.subglutinans</i> (MRC6228)	--C..C-.G.	C.....-C..	.....TT	.....	.C..C.....	.....
<i>F.subglutinans</i> (MRC7439)	--C..C-.G.	C.....-C..	.....TT	.....	.C..C.....	.....
<i>F.subglutinans</i> (MRC7438)	--C..C-.G.	C.....-C..	.....TT	.....	.C..C.....	.....
<i>F.subglutinans</i> (MRC7437)	--C..C-.G.	C.....-C..	.....TT	.....	.C..C.....	.....
<b>Host = mango</b>						
<i>F.subglutinans</i> (MRC7038)	GG...CT-G.	.C.....-C.C	.....TC	.....	.C.....	.....
<i>F.subglutinans</i> (MRC7037)	GG...CT-G.	.C.....-C.C	.....TC	.....	.C.....	.....
<i>F.subglutinans</i> (MRC7034)	GG...CT-G.	.C.....-C.C	.....TC	.....	.C.....	.....
<i>F.subglutinans</i> (MRC2730)	GG...CT-G.	.C.....-C.C	.....TC	.....	.C.....	.....
<i>F.subglutinans</i> (MRC7035)	GG...CT-G.	.C.....-C.C	.....TC	.....	.C.....	.....
<i>F.subglutinans</i> (MRC3479)	GG...CT-G.	.C.....-C.C	.....TC	.....	.C.....	.....
<i>F.subglutinans</i> (MRC3477)	GG...CT-G.	.C.....-C.C	.....TC	.....	.C.....	.....
<i>F.subglutinans</i> (MRC3478)	GG...CT-G.	.C.....-C.C	.....TC	.....	.C.....	.....
<b>MP-B; Host = Sugarcane</b>						
<i>F.subglutinans</i> (MRC6525)	GCC..C-.AT	.....G-C..	.....TC	.....	.C.....	.....
<i>F.subglutinans</i> (MRC6524)	GCC..C-.AT	.....G-C..	.....TC	.....	.C.....	.....
<b>MP-G</b>						
<i>F.nygamai</i> (MRC7548)	--...C-.G.	.....-C..	.....CTC	.....	.C.....	.....
<i>F.nygamai</i> (MRC7549)	--...C-.G.	.....-C..	.....CTC	.....	.C.....	.....
<b>MP-F</b>						
<i>F.thapsinum</i> (MRC6537)	--...C-.G.	.....-C..	.....TC	..T.....	.C.....A..	..T.....
<i>F.thapsinum</i> (MRC6536)	--...C-.G.	.....-C..	.....TC	..T.....	.C.....A..	..T.....
<b>MP-A</b>						
<i>F.moniliforme</i> (MRC6155)	--C..C-.G.	C.....-C..	.....CTT	.GT.....	.C.....	C.....
<i>F.moniliforme</i> (MRC6191)	--C..C-.G.	C.....-C..	.....CTT	.GT.....	.C.....	C.....
<b>MP-D</b>						
<i>F.proliferatum</i> (MRC6569)	G-...C-.G.	.....G-C..	.....TC	..G.....	.....	.....
<i>F.proliferatum</i> (MRC6568)	G-...C-.G.	.....G-C..	.....TC	..G.....	.....	.....
<b>MP-C</b>						
<i>F.proliferatum</i> (MRC6571)	G-...C-.G.	C.....-C..	.....TC	..G.....	.C.....	.....
<i>F.proliferatum</i> (MRC6570)	G-...C-.G.	C.....-C..	.....TC	..G.....	.C.....	.....



	370	380	390	400	410	420
<i>F.oxysporum</i> (MRC6212)	TTCAAGTCTG	ATCTCCGCTT	CCAGTCTTCT	GCCATCGGTG	CTCTCCAGGA	GTCCGTTGAG
<b>Host = Pineapple</b>						
<i>F.subglutinans</i> (MRC6783)			C	T		T.C
<i>F.subglutinans</i> (MRC6784)			C	T		T.C
<i>F.subglutinans</i> (MRC6785)			C	T		T.C
<i>F.subglutinans</i> (MRC6782)			C	T		T.C
<b>MP-E; Host = Maize</b>						
<i>F.subglutinans</i> (MRC1077)		C	C			T
<i>F.subglutinans</i> (MRC1084)		C	C			T
<i>F.subglutinans</i> (MRC756)		C	C			T
<i>F.subglutinans</i> (MRC837)		C	C			T
<i>F.subglutinans</i> (MRC714)			C			T
<i>F.subglutinans</i> (MRC620)		C	C			T
<i>F.subglutinans</i> (MRC115)			C			T
<i>F.subglutinans</i> (MRC6512)			C			T
<i>F.subglutinans</i> (MRC6483)			C			T
<b>MP-H; Host = Pine</b>						
<i>F.subglutinans</i> (MRC6209)	C		C			T.C
<i>F.subglutinans</i> (MRC6211)	C		C			T.C
<i>F.subglutinans</i> (MRC7440)	C		C			T.C
<i>F.subglutinans</i> (MRC6213)	C		C			T.C
<i>F.subglutinans</i> (MRC6228)	C		C			T.C
<i>F.subglutinans</i> (MRC7439)	C		C			T.C
<i>F.subglutinans</i> (MRC7438)	C		C			T.C
<i>F.subglutinans</i> (MRC7437)	C		C			T.C
<b>Host = mango</b>						
<i>F.subglutinans</i> (MRC7038)				T		
<i>F.subglutinans</i> (MRC7037)				T		
<i>F.subglutinans</i> (MRC7034)				T		
<i>F.subglutinans</i> (MRC2730)				T		
<i>F.subglutinans</i> (MRC7035)				T		
<i>F.subglutinans</i> (MRC3479)				T		
<i>F.subglutinans</i> (MRC3477)				T		
<i>F.subglutinans</i> (MRC3478)				T		
<b>MP-B; Host = Sugarcane</b>						
<i>F.subglutinans</i> (MRC6525)						C
<i>F.subglutinans</i> (MRC6524)						C
<b>MP-G</b>						
<i>F.nygamai</i> (MRC7548)						C
<i>F.nygamai</i> (MRC7549)						C
<b>MP-F</b>						
<i>F.thapsinum</i> (MRC6537)			C		A	C
<i>F.thapsinum</i> (MRC6536)			C		A	C
<b>MP-A</b>						
<i>F.moniliforme</i> (MRC6155)						C
<i>F.moniliforme</i> (MRC6191)						C
<b>MP-D</b>						
<i>F.proliferatum</i> (MRC6569)			C			C
<i>F.proliferatum</i> (MRC6568)			C			C
<b>MP-C</b>						
<i>F.proliferatum</i> (MRC6571)			C			C
<i>F.proliferatum</i> (MRC6570)			C			C



	430	440	450	460	470	477
<i>F. oxysporum</i> (MRC6212)	TCCTACCTCG	TCTCCCTCTT	CGAGGACACC	AACCTCTGCG	CCATCCATGC	CAAGCGT
<b>Host = Pineapple</b>						
<i>F. subglutinans</i> (MRC6783)	.....	.....	.....T...	.....	.....C..	.....
<i>F. subglutinans</i> (MRC6784)	.....	.....	.....T...	.....	.....C..	.....
<i>F. subglutinans</i> (MRC6785)	.....	.....	.....T...	.....	.....C..	.....
<i>F. subglutinans</i> (MRC6782)	.....	.....	.....T...	.....	.....C..	.....
<b>MP-E; Host = Maize</b>						
<i>F. subglutinans</i> (MRC1077)	.....	.....	T.....T...	.....T..	.....C..	.....
<i>F. subglutinans</i> (MRC1084)	.....	.....	T.....T...	.....T..	.....C..	.....
<i>F. subglutinans</i> (MRC756)	.....	.....	T.....T...	.....T..	.....C..	.....
<i>F. subglutinans</i> (MRC837)	.....	.....	T.....T...	.....T..	.....C..	.....
<i>F. subglutinans</i> (MRC714)	.....	.....	T.....T...	.....T..	.....C..	.....
<i>F. subglutinans</i> (MRC620)	.....	.....	T.....T...	.....T..	.....C..	.....
<i>F. subglutinans</i> (MRC115)	.....	.....	T.....T...	.....T..	.....C..	.....
<i>F. subglutinans</i> (MRC6512)	.....	.....	T.....T...	.....T..	.....C..	.....
<i>F. subglutinans</i> (MRC6483)	.....	.....	T.....T...	.....T..	.....C..	.....
<b>MP-H; Host = Pine</b>						
<i>F. subglutinans</i> (MRC6209)	..T.....	.....	.....T...	.....T..	.....C..	.....
<i>F. subglutinans</i> (MRC6211)	..T.....	.....	.....T...	.....T..	.....C..	.....
<i>F. subglutinans</i> (MRC7440)	..T.....	.....	.....T...	.....T..	.....C..	.....
<i>F. subglutinans</i> (MRC6213)	..T.....	.....	.....T...	.....T..	.....C..	.....
<i>F. subglutinans</i> (MRC6228)	..T.....	.....	.....T...	.....T..	.....C..	.....
<i>F. subglutinans</i> (MRC7439)	..T.....	.....	.....T...	.....T..	.....C..	.....
<i>F. subglutinans</i> (MRC7438)	..T.....	.....	.....T...	.....T..	.....C..	.....
<i>F. subglutinans</i> (MRC7437)	..T.....	.....	.....T...	.....T..	.....C..	.....
<b>Host = mango</b>						
<i>F. subglutinans</i> (MRC7038)	..A.....	.....	T.....	.....	..T....C..	T.....
<i>F. subglutinans</i> (MRC7037)	..A.....	.....	T.....	.....	..T....C..	T.....
<i>F. subglutinans</i> (MRC7034)	..A.....	.....	T.....	.....	..T....C..	T.....
<i>F. subglutinans</i> (MRC2730)	..A.....	.....	T.....	.....	..T....C..	T.....
<i>F. subglutinans</i> (MRC7035)	..A.....	.....	T.....	.....	..T....C..	T.....
<i>F. subglutinans</i> (MRC3479)	..A.....	.....	T.....	.....	..T....C..	T.....
<i>F. subglutinans</i> (MRC3477)	..A.....	.....	T.....	.....	..T....C..	T.....
<i>F. subglutinans</i> (MRC3478)	..A.....	.....	T.....	.....	..T....C..	T.....
<b>MP-B; Host = Sugarcane</b>						
<i>F. subglutinans</i> (MRC6525)	.....	.....	.....T...	.....	.....C..	.....
<i>F. subglutinans</i> (MRC6524)	.....	.....	.....T...	.....	.....C..	.....
<b>MP-G</b>						
<i>F. nygamai</i> (MRC7548)	..T.....	.....	.....	.....	.....C..	.....
<i>F. nygamai</i> (MRC7549)	..T.....	.....	.....	.....	.....C..	.....
<b>MP-F</b>						
<i>F. thapsinum</i> (MRC6537)	..T.....	.....	T.....	.....	.....C..	.....
<i>F. thapsinum</i> (MRC6536)	..T.....	.....	T.....	.....	.....C..	.....
<b>MP-A</b>						
<i>F. moniliforme</i> (MRC6155)	..T.....	.....	.....	.....	.....	G.....
<i>F. moniliforme</i> (MRC6191)	..T.....	.....	.....	.....	.....	G.....
<b>MP-D</b>						
<i>F. proliferatum</i> (MRC6569)	.....	.....	T..A.....	..T....T..	.....C..	.....
<i>F. proliferatum</i> (MRC6568)	.....	.....	T..A.....	..T....T..	.....C..	.....
<b>MP-C</b>						
<i>F. proliferatum</i> (MRC6571)	.....	.....	T.....	.....T..	.....	.....
<i>F. proliferatum</i> (MRC6570)	.....	.....	T.....	.....T..	.....	.....

## APPENDIX 2

Aligned DNA sequence for the *MAT-2* high-mobility-group (HMG) domain and 3'-idiomorph flank, as well as the *MAT-1*  $\alpha$ -domain. These sequences were obtained for the *MAT-1* and *MAT-2* mating tester strains for each of the eight *Gibberella fujikuroi* mating populations (MP-A to MP-H). These sequences were used to construct specific primer sets to identify the mating types of individuals in the *G. fujikuroi* complex (Steenkamp et al. 2000, Appl. Environ. Microbiol. 66:4378-4382; Chapter 3 of this thesis). Nucleotides similar to those of MP-A are indicated as dots, whereas nucleotide deletions are indicated by vertical lines (-).

### Partial *MAT-1* $\alpha$ -domain

	10	20	30	40	50	60
MP-A	GAAGACCAAC	TCAAACCTCA	TGGCGCTCTG	GGTACTGCGG	ATTTCGAAGGC	TAAGCGCCCT
MP-B	.....	.....	.....	..C..C....	.....	.....
MP-C	.....	.....G	.....	.....	.....G..	.....
MP-D	.....	.....	.....	.....	.....G..	.....
MP-E	.....	.....	...A..A..	..C.....	.....G..	.....
MP-F	.....	.....	.....	.....	.....	.....
MP-G	.....	.....	.....	.....	.....	.....
MP-H	.....	.....	...A..A..	..C.....	.....G..T	.....
<i>F. oxysporum</i>	...G.G..A	.....C..	...C....A	.....CT..	.....G..	.....

	70	80	90	100	110	120
MP-A	CTTAACGCCT	TCATGGCCTT	TCGCAGTAAG	TGTGAGT-C-	----CTTTT-	-ACCTATGGC
MP-B	.....	.....	.....	...A.A--A	TT-----	C.....A..
MP-C	.....	.....	.....	...A.--A	TT-----	.....
MP-D	.....	.....	.....	.T..A.--A	TT-----	.....C....
MP-E	.....	.....	.....	...A.A--A	----.....T	.....A.
MP-F	.....	.....	.....	...A.T--	----.....-	-.T..G...T
MP-G	.....	.....	.....	...A.T--	----.....-	.....
MP-H	.....	.....	.....	...AGA.--A	----.....T	.....A.
<i>F. oxysporum</i>	.....	.....	.....	A..A.A--A	TTTG.....T	C-----

	130	140	150	160	170	180
MP-A	ACCTATTGAC	CAGATCTAGC	CTACTATCTG	AAGCTATTCC	CCGACACCCA	GCAGAAGAAT
MP-B	..A.....	.....A....	.....	.....	.....T....	.....
MP-C	T.....	.....	.....	.....	.....	.....
MP-D	T.....	.....	.....	.....	.....	.....
MP-E	.....	.....C....	.....	.....	.....	.....
MP-F	.....	.....	...T....	.....	.....	.....
MP-G	.....	.....	.....	..A....	.....	.....
MP-H	.....	.....C....	.....	.....	.....	.....
<i>F. oxysporum</i>	..G.....	.....	.....T..	.....G....	.....T....	.....





	190	200	210	220	230	240
MP-A	GCCTCCGGTT	TCCTGACTCA	GCTCTGGGGC	GGCGACCCTC	ACCGAAACAA	ATGGGCCCTG
MP-B	.....	.....C..	.....	.....	.....	.....
MP-C	.....	.....C..	.....	.....	.....	.....
MP-D	.....	.....C..	.....	.....	.....	.....
MP-E	.....	.....C..	.....	.....	...A.....	.....
MP-F	.....	.....C..	.....	.....	.....	.....A...
MP-G	.....	.....C..	.....	.....	.....	.....
MP-H	.....	.....C..	.....	.....	.....	.....
<i>F. oxysporum</i>	.....	.....C..	.....	.....	.....	.....

	250	260	270	280	290	300
MP-A	ATTGCTAAAG	TCTATTCCTT	TCTCCGCGAT	CAACTCGGCA	AGAGTACCGT	TAACTTGTC
MP-B	.....	.....	.....	.....	..G.....	.....A...
MP-C	.....C...	.....	.....	.....	.....	.....A...
MP-D	.....C...	.....	.....	.....	.....	.....A...
MP-E	.....	.A.....	C.....T..	.....	..G....T..	.....
MP-F	.....	.....	.....	.....	.....	.....
MP-G	.....	.....	.....	.....	.....	.....
MP-H	.....	.....	C.....	.....	..G....T..	.....
<i>F. oxysporum</i>	.....	.....	...T.....	.....	..G..C.T..	.....

	310	320	330	335
MP-A	GCATTCCTTG	GTATCGCTTG	CCCTTTGATG	AACAT
MP-B	..G.....	.....	.....	.....
MP-C	.....	.....	.....	..T..
MP-D	.....	.....	.....	.....
MP-E	..G.....	.....	.....	.....
MP-F	..G.....	.A.....	.....	.....
MP-G	..G.....	.....	.....	.....
MP-H	..G.....	.....	.....	.....
<i>F. oxysporum</i>	..C.....	.C.....	.....A...	.....



**Partial MAT-2 HMG-domain and 3'-idiomorph flank**

	10	20	30	40	50	60
MP-A	AACGTCACCA	TTCGATCAAG	GCTCAACGCC	CCGACATCAC	CAACAATGAA	ATCTGTAAGT
MP-B	.G.....	C.....	.....A..	.T.....	.....	.....
MP-C	.G.....	.....	.....	.T..T...	.....	.....
MP-D	.G.....	.G.....	.....	.T..T...	.....	.....
MP-E	.G.....	.....	.....G...	.....	.....	.....
MP-F	.....	C.....	.....G...	.....	.....	.....
MP-G	CGG.....	.....	.....	.....	.....	.....
MP-H	.G.....	.....	.....G...	.....	.....	.....
<i>F. oxysporum</i>	.....	G.....	.....	.G.....	..T.....	.....

	70	80	90	100	110	120
MP-A	AGTTCATACC	CATTT-ACAA	GACATCACTG	ACATCGTTTT	AGCCCAGGTC	CTCGGTCGCC
MP-B	.....	.....C-....	.....GT..	.....G...	.....A...	..T..C....
MP-C	.....G..	.....C-....	.....	.....G..C	.....A...	..T..C....
MP-D	.....G..	.....C-....	.....	.....G..C	.....A...	.....C....
MP-E	.....G..	.....-G....	.....	.....T.G...	.....	..T..C....
MP-F	.....	.....-..G.	.....T...	.....	.....	.....C....
MP-G	.....	.....-....	.....	.....	.....	.....C....
MP-H	.....G..	.....-G....	.....	.....T.G...	.....	..T..C....
<i>F. oxysporum</i>	....T..G..	.....-....	.....	.....	.....	..T..C....

	130	140	150	160	170	180
MP-A	TCTGGAAGTC	AGAGACCCGT	GAGGTTGCGG	CACTCTACAA	GCAGATGGAG	GATCAGAAAA
MP-B	.....	C.....	.....	.....	.....CA	.....
MP-C	.....	C.....	.....	.....	.....C.	.....
MP-D	.....	C.....	.....	.....	.....C.	.....
MP-E	.....	C.....C	.....	.....T..	.....C.	.....
MP-F	.....	.....	.....	.....	.....C.	.....
MP-G	.....	.....	.....	.....	.....C.	.....
MP-H	.....	C.....C	.....	.....	.....C.	.....
<i>F. oxysporum</i>	.....	C.....	.....	.....	.....C.	.....

	190	200	210	220	230	240
MP-A	AGGCCGAACA	TCGCCGACAG	TACCCCGACT	ACCAGTACCG	CCCTCGTTCGT	CCTTCTGAGC
MP-B	.....	..A...A	.....	.....	.....	.....
MP-C	.....	.....	.....	.....	.....	.....
MP-D	.....	C.....	.....T...	.....	.....	.....G....
MP-E	.....	.....	.....	.....	.....	.....
MP-F	.....	.....	.....	.....	.....	.....
MP-G	.....	.....	.....	.....	.....	.....
MP-H	.....	.T.....	.....	.....	.....	.....
<i>F. oxysporum</i>	.....	.....	.....	.....	.....	.....

	250	260	270	280	290	300
MP-A	GACGCCGTCG	CAACAATGCC	TCGTCTGACA	GAAGCACAGC	GACTATTGCT	GTTACACAGC
MP-B	.G.....	.....T	.....	.C..T....	....TC.A..	..CG.....
MP-C	.G.....	.....T	.....	.C..T....	....C.A..	..CG.....
MP-D	.G.....	.....T	.....	.C..T....	....C.A..	..CG.....
MP-E	.....	.....T	.....	.C..G....	....C.A..	.....
MP-F	.....	.....	.....	.C..T....	....C....	C.....
MP-G	.....	.....	.....	.C..T....	....C....	.....
MP-H	.....	.....T	.....	.C..G....	....C.A..	.....
<i>F. oxysporum</i>	.....	.....T	.....	..T.....	.G..C.A..	.G.....



	310	320	330	340	350	360
MP-A	AGATGACCGC	CTAAGAGGCT	CATATGGGAA	CTTCTTCATT	TCGATAAGCA	CAAGCCACCT
MP-B	....C..G..	.....T.	....C....	.....C	....G....	.TG...CT.-
MP-C	....T.....	.....	.C..C....	....-T-..	....G....	.TG...CT..
MP-D	....T..A..	.....T.	.C..C....	.....T..	.....G	.TG...CT..
MP-E	..G.T.G...	.....A	....C....	.....C	....G....	.TC...TG.
MP-F	.....	.....	T.....	.....C	.TCGAC.AGC	ACTAG.CA.C
MP-G	....C.....	.....	.....	.....C	.....	.T.....
MP-H	..G.T.G...	.....A	....C....	.....C	....G....	.TG...TG.
<i>F. oxysporum</i>	....T.....	.....	....C....	.....C	....G....	.TG...T..

	370	380	390	400	410	420
MP-A	TT--GTGATT	T--GAGCACA	ATTCTCAGAC	GACAAACGTA	AGTCGAAGAA	CATAAAG---
MP-B	----.....	.T-.....T.	..C...G...	.....	.....	T..G...---
MP-C	.CAC--.....	.TGA.-..TG	..CT..G...	.....	.....	T..G...---
MP-D	.C-C-.....	.T-.....TG	..C...G...	.....	.....	T..G...---
MP-E	..A--.A...	.T-.....T.	..C.....T	.....	.....	T.....CAG
MP-F	..T--GTGA.	.TG.....T.	.....	.....	.....	..T...---
MP-G	..--.....	..--.....T.	.....	.....	.....	.....---
MP-H	..A--.A...	.T-.....T.	..C.....T	.....	.....	T.....CAG
<i>F. oxysporum</i>	..--.....CC	.T-.....T.	..C.....	.....	.....G.	T.C...CTG

	430	440	450	460	470	480
MP-A	CT-CAACAGC	A-GTCACTAA	TTCAGTTTTT	TATAGGGAGA	CTGGAA-GAA	CTGCTTGTCG
MP-B	..-.-.....	-.....	..T.....GA	.....A...	.....-A..	.....
MP-C	..-.-G....	-.....	..T.....GA	.....A..G	.....-A..	.....T.
MP-D	..-.....	-.....	..T.....GA	.....A..G	.....-A..	..T.....
MP-E	..-.....	-..G.....	.....GA	.C..A....	.....-A..	..G-----
MP-F	..T.....	-.....	.....C-	.....-	.....-A..	..A....
MP-G	..-.-.....	.G.....	.....-	.....-	.....-	T.....-
MP-H	..-.....	-.....	.....GA	.....A....	.....-A..	.....-
<i>F. oxysporum</i>	G---.-.....	-.....	..TA..GA	.GC..A....	.....T...	T.....

	490	500	510	520	530	540
MP-A	TTTGCCGAAT	CTCGGTTGCC	TGGGGTTCCG	GACACCGATG	AAGGAAGTGA	TGTATTTGTG
MP-B	..A..C...	.....	.....G.T..	.....A..C	..-...C..	.....
MP-C	..A..C...	.....C...	.....G.T..	.....A...	.....	.....C...
MP-D	..A..C...	.....C...	.....G.T..	.....A...	.....C..	.TG...-..
MP-E	-.A..C.C.	--...A..	.....T..	.....A...	..-..G.C..	.....
MP-F	.....TC...	.....	.....T..	.....T...	..-...C..	....C....
MP-G	.....T...	.....	.....T..	.....T...	..-...C..	.....
MP-H	-.A..C.C.	--...A..	.....T..	.....A...	..-...C..	.....
<i>F. oxysporum</i>	..A..C...	.....	.....-T..	.....TA....	.....C..	.....

	550	560	570	580	590	600
MP-A	G-ATTTGACG	ATACCCGTGG	ATTGCAAGCC	ACGCAACCCA	CTCGCTTTGT	TTCTTGTGTC
MP-B	..-.....	.....A.-.	.....G	G.....	.....	.....
MP-C	..-.....	.....A..	.....G	G.....	G.....	.....A....
MP-D	.T.....	.....A..	.....G	G.....	G.....	.....A....
MP-E	..-.....	.....	.....G	G.....TT..	.....	.....
MP-F	..-A.....	.....	.....G	G.....	.....	.....AA....
MP-G	..-.....	.....-	.....G	G.....	..G.....	.....A....
MP-H	..-.....	.....	.....G	G.....TT..	.....	.....
<i>F. oxysporum</i>	..-.....	.....	.....A	G.....	.....	.....A....



	610	620	630	640	650	660
MP-A	ACTAGGTTGA	AGGACATATC	TCTTCTCTGA	AGACAGGAAG	CGTAATGGAT	AGGTAGCTAG
MP-B	.....C.T	.....G..	.A...T...	.....	.C.....	.....
MP-C	.....	-.....G..	.....	.....	.A.....	..A..A...
MP-D	.....	-.....G..	.....	C.....	.A.....	..A..A...
MP-E	.....C.T	.....C..	.....T..	G.....	TC...A..	.....
MP-F	.....	-.....	.....	.....G..	.....	.....
MP-G	.....	-.....	.....	.....C..	T.....	.....
MP-H	.....C.T	.....C..	.....T..	G.....	TC...A..	.....
<i>F. oxysporum</i>	.....AAT	.....GC..	.....G	.....	.C.....	.....

	670	680	690	700	710	720
MP-A	CACATTGACA	ACGTATCGCG	TTGTTCGATG	GTGGAAAGAA	AATACAAGAG	AGACCAAAGA
MP-B	T..G.....	.....	...C..T.G.	.A...C..G.	....T..T..	..GTTC....
MP-C	.....T...	G.....A..	.....TG..	.....C...	.....T....	.....
MP-D	...G.....	.....A..	.....TG..	A...C...	.....T....	.....
MP-E	..T.....	..A.....	.....TG..	.....C.A.T	.....	.....
MP-F	.....	.....	.....T..	.....	-.....	.....
MP-G	.....	.....	.....T..	.....	.....	.....
MP-H	..T.....	..A.....	.....TG..	.....C..T	.....	.....
<i>F. oxysporum</i>	...G.....G	.....	.....TG..	.....C....	G.....T..	.....

	730	740	750	760	770	780
MP-A	CTTAAGTCTA	TCGTGATTAC	GATGCTGTCA	GTGACATGGC	AACTTGGTGC	TATTGACCGT
MP-B	..C..T....	....CC....	.....TG	.....C....	.....C..A.	.....T...
MP-C	....G..TG.	.T.....	.....T.	.....	.....GA.	.....T...
MP-D	.....T....	.T.....T	.....T.	.....	.....A.	.....T...
MP-E	..CT.T....	.....	.....C..	.....	.....A.	.C...T...
MP-F	...G.A....	.....G.	.....	.....	.....A.	C...A.T...
MP-G	.....	.....	.....	.....A.	.....A.	.....T...
MP-H	..CT.T....	.....	.....C..	.....	..CN..A.	.C...T...
<i>F. oxysporum</i>	..C..C....	.....G....	.....A..G	.....A.	.....A.	.G...T...

	790	800	810	820
MP-A	AACACAGATA	AGTTCCCTAC	TGTACAACCTC	TCAACGTAG
MP-B	.....A.	.C..T....	.....G..	.....
MP-C	.....	.....	.....	.....
MP-D	.....C..	.....	.....G..	.....
MP-E	.....A..	.....T.-..	.....G..	.....
MP-F	...C.....	.....	.....G..	.....
MP-G	.....	.....	.....	.....
MP-H	.....A..	.....-	.....G..	.....
<i>F. oxysporum</i>	.....T...	.A.....	C.GG..G..	.T.....



## APPENDIX 3

Aligned histone *H3* and  $\beta$ -tubulin DNA sequences for selected *Fusarium* strains in the *Gibberella fujikuroi* complex. These sequences were used to show that mango malformation in South Africa is associated with two distinct species in the *G. fujikuroi* complex (Steenkamp et al. 2000, Mol. Plant Pathol. 1:187-193; Chapter 4 of this thesis). Nucleotides similar to those of *F. oxysporum* are indicated as dots, whereas nucleotide deletions are indicated by vertical lines (-).

### Histone *H3*

	10	20	30	40	50	60
<i>F. oxysporum</i>	GGTGGCAAGG	CCCCTCGCAA	GCAGCTCGCT	TCCAAGGCCG	GTAAGTC-TT	C--ACCGCGA
<b>Host = Pineapple</b>						
<i>F. subglutinans</i> (MRC6783)	.....	.....	.....	.....T.	.....-	..-.....
<i>F. subglutinans</i> (MRC6782)	.....	.....	.....	.....T.	.....-	..-.....
<b>MP-E; Host = Maize</b>						
<i>F. subglutinans</i> (MRC6512)	.....	.....	.....	.....T.	.....A-	..-.....
<i>F. subglutinans</i> (MRC6483)	.....	.....	.....	.....T.	.....A-	..-.....
<b>MP-H; Host = Pine</b>						
<i>F. subglutinans</i> (MRC6213)	.....	.....	.....	.....T.	.....-	..-.....
<i>F. subglutinans</i> (MRC6228)	.....	.....	.....	.....T.	.....-	..-.....
<b>Host = Mango (1)</b>						
<i>F. subglutinans</i> (MRC7873)	.....	.....	.....	.....T.	.....-	..-.....
<i>F. subglutinans</i> (MRC7605)	.....	.....	.....	.....T.	.....-	..-.....
<i>F. subglutinans</i> (MRC7875)	.....	.....	.....	.....T.	.....-	..-.....
<i>F. subglutinans</i> (MRC7876)	.....	.....	.....	.....T.	.....-	..-.....
<i>F. subglutinans</i> (MRC7877)	.....	.....	.....	.....T.	.....-	..-.....
<i>F. subglutinans</i> (MRC2802)	.....	.....	.....	.....T.	.....-	..-.....
<b>Host = Mango (2)</b>						
<i>F. subglutinans</i> (MRC7038)	.....	.....	.....C	.....T.	.....-	..-.....
<i>F. subglutinans</i> (MRC7037)	.....	.....	.....C	.....T.	.....-	..-.....
<i>F. subglutinans</i> (MRC7034)	.....	.....	.....C	.....T.	.....-	..-.....
<i>F. subglutinans</i> (MRC2730)	.....	.....	.....C	.....T.	.....-	..-.....
<i>F. subglutinans</i> (MRC7035)	.....	.....	.....C	.....T.	.....-	..-.....
<i>F. subglutinans</i> (MRC3479)	.....	.....	.....C	.....T.	.....-	..-.....
<i>F. subglutinans</i> (MRC3477)	.....	.....	.....C	.....T.	.....-	..-.....
<i>F. subglutinans</i> (MRC3478)	.....	.....	.....C	.....T.	.....-	..-.....
<i>F. subglutinans</i> (MRC7559)	.....	.....	.....C	.....T.	.....-	..-.....
<i>F. subglutinans</i> (MRC7560)	.....	.....	.....C	.....T.	.....-	..-.....
<i>F. subglutinans</i> (MRC7561)	.....	.....	.....C	.....T.	.....-	..-.....
<i>F. subglutinans</i> (MRC7562)	.....	.....	.....C	.....T.	.....-	..-.....
<b>MP-G</b>						
<i>F. nygamai</i> (MRC7548)	.....	.....	.....	.....T.	.....-	..TC.....
<i>F. nygamai</i> (MRC7549)	.....	.....	.....	.....T.	.....-	..TC.....
<b>MP-F</b>						
<i>F. thapsinum</i> (MRC6537)	.....	.....	.....	.....A..T.	.....-	..TC.....
<i>F. thapsinum</i> (MRC6536)	.....	.....	.....	.....A..T.	.....-	..TC.....
<b>MP-A</b>						
<i>F. verticillioides</i> (MRC6155)	.....	.....	.....	.....T.	.....-	..TC.....
<i>F. verticillioides</i> (MRC6191)	.....	.....	.....	.....T.	.....-	..TC.....
<b>MP-B; Host = Sugarcane</b>						
<i>F. subglutinans</i> (MRC6525)	.....	.....	.....G..C	.....T..T.	.....-	..-.....
<i>F. subglutinans</i> (MRC6524)	.....	.....	.....G..C	.....T..T.	.....-	..-.....
<b>MP-D</b>						
<i>F. proliferatum</i> (MRC6569)	.....	.....	.....T....	.....T..T.	.....-	..-.....
<i>F. proliferatum</i> (MRC6568)	.....	.....	.....T....	.....T..T.	.....-	..-.....
<b>MP-C</b>						
<i>F. fujikuroi</i> (MRC6571)	.....	.....	.....C..T.	.....T..T.	.....-	..-C...C...
<i>F. fujikuroi</i> (MRC6570)	.....	.....	.....C..T.	.....T..T.	.....-	..-C...C...



	70	80	90	100	110	120
<i>F. oxysporum</i>	CTTT-ATCTC	GACGCGACA-	CACGTCTT-G	ATAC-ATA-A	AAAACGCC-A	TAACCTAAC-A
<b>Host = Pineapple</b>						
<i>F. subglutinans</i> (MRC6783)	...-C.A...	.....- .G.....-	G.C.-.C-	....A.-.	.C.....T-	
<i>F. subglutinans</i> (MRC6782)	...-C.A...	.....- .G.....-	G.C.-.C-	....A.-.	.C.....T-	
<b>MP-E; Host = Maize</b>						
<i>F. subglutinans</i> (MRC6512)	...-G.A...	.....- .G.....-	G.C.-.C-	....A.-.	.C.....T-	
<i>F. subglutinans</i> (MRC6483)	...-G.A...	.....- .G.....-	G.C.-.C-	....A.-.	.C.....T-	
<b>MP-H; Host = Pine</b>						
<i>F. subglutinans</i> (MRC6213)	...-C.A...	.....- .G.....-	G.C.-.C-	....A.-.	.C.....T-	
<i>F. subglutinans</i> (MRC6228)	...-C.A...	.....- .G.....-	G.C.-.C-	....A.-.	.C.....T-	
<b>Host = Mango (1)</b>						
<i>F. subglutinans</i> (MRC7873)	...-C.A..G	.....- .G.....-	G.C.-.C-	....A.-.	.C.....T-	
<i>F. subglutinans</i> (MRC7605)	...-C.A..G	.....- .G.....-	G.C.-.C-	....A.-.	.C.....T-	
<i>F. subglutinans</i> (MRC7875)	...-C.A..G	.....- .G.....-	G.C.-.C-	....A.-.	.C.....T-	
<i>F. subglutinans</i> (MRC7876)	...-C.A..G	.....- .G.....-	G.C.-.C-	....A.-.	.C.....T-	
<i>F. subglutinans</i> (MRC7877)	...-C.A..G	.....- .G.....-	G.C.-.C-	....A.-.	.C.....T-	
<i>F. subglutinans</i> (MRC2802)	...-C.A..G	.....- .G.....-	G.C.-.C-	....A.-.	.C.....T-	
<b>Host = Mango (2)</b>						
<i>F. subglutinans</i> (MRC7038)	..C-C.A...	.....- .G.....-	G.T-A..C-	....AT-GG	.C.....T-	
<i>F. subglutinans</i> (MRC7037)	..C-C.A...	.....- .G.....-	G.T-A..C-	....AT-GG	.C.....T-	
<i>F. subglutinans</i> (MRC7034)	..C-C.A...	.....- .G.....-	G.T-A..C-	....AT-GG	.C.....T-	
<i>F. subglutinans</i> (MRC2730)	..C-C.A...	.....- .G.....-	G.T-A..C-	....AT-GG	.C.....T-	
<i>F. subglutinans</i> (MRC7035)	..C-C.A...	.....- .G.....-	G.T-A..C-	....AT-GG	.C.....T-	
<i>F. subglutinans</i> (MRC3479)	..C-C.A...	.....- .G.....-	G.T-A..C-	....AT-GG	.C.....T-	
<i>F. subglutinans</i> (MRC3477)	..C-C.A...	.....- .G.....-	G.T-A..C-	....AT-GG	.C.....T-	
<i>F. subglutinans</i> (MRC3478)	..C-C.A...	.....- .G.....-	G.T-A..C-	....AT-GG	.C.....T-	
<i>F. subglutinans</i> (MRC7559)	..C-C.A...	.....- .G.....-	G.T-A..C-	....AT-GG	.C.....T-	
<i>F. subglutinans</i> (MRC7560)	..C-C.A...	.....- .G.....-	G.T-A..C-	....AT-GG	.C.....T-	
<i>F. subglutinans</i> (MRC7561)	..C-C.A...	.....- .G.....-	G.T-A..C-	....AT-GG	.C.....T-	
<i>F. subglutinans</i> (MRC7562)	..C-C.A...	.....- .G.....-	G.T-A..C-	....AT-GG	.C.....T-	
<b>MP-G</b>						
<i>F. nygamai</i> (MRC7548)	...-C.A...	.....- .G.....-	G.C.-.C-	...G.AT.-	.C.....T-	
<i>F. nygamai</i> (MRC7549)	...-C.A...	.....- .G.....-	G.C.-.C-	...G.AT.-	.C.....T-	
<b>MP-F</b>						
<i>F. thapsinum</i> (MRC6537)	...-G.A.C. .T.....	.....- .G.....-	G.GC.-.C-	....ATT-	CC.....TT	
<i>F. thapsinum</i> (MRC6536)	...-G.A.C. .T.....	.....- .G.....-	G.GC.-.C-	....ATT-	CC.....TT	
<b>MP-A</b>						
<i>F. verticillioides</i> (MRC6155)	...-C.A.CT .....T-	.....- .G.....C-	G.T.-.C-	...G.AT.-G	.C.....TT	
<i>F. verticillioides</i> (MRC6191)	...-C.A.CT .....T-	.....- .G.....C-	G.T.-.C-	...G.AT.-G	.C.....TT	
<b>MP-B; Host = Sugarcane</b>						
<i>F. subglutinans</i> (MRC6525)	..C-C.A...	.....- .G.....-	G.T-A..CC.	----ATT-	.C..C..TG	
<i>F. subglutinans</i> (MRC6524)	..C-C.A...	.....- .G.....-	G.T-A..CC.	----ATT-	.C..C..TG	
<b>MP-D</b>						
<i>F. proliferatum</i> (MRC6569)	...-C.A... ..TG-T	.....- .G.....-G	G.--A.-CC.	....AT-G	CC.....T-	
<i>F. proliferatum</i> (MRC6568)	...-C.A... ..TG-T	.....- .G.....-G	G.--A.-CC.	....AT-G	CC.....T-	
<b>MP-C</b>						
<i>F. fujikuroi</i> (MRC6571)	...-C.A... ..TG-T	.....- .G.....-G	G.--A.-CC.	....AT-G	CC.....T-	
<i>F. fujikuroi</i> (MRC6570)	...-C.A... ..TG-T	.....- .G.....-G	G.--A.-CC.	....AT-G	CC.....T-	



	130	140	150	160	170	180
<i>F. oxysporum</i>	TCATCACCAA	CAGCCCGCAA	GTCCGCCCCC	TCTACCGGAG	GTGTCAAGAA	GCCTCACCGC
<b>Host = Pineapple</b>						
<i>F. subglutinans</i> (MRC6783)	..G.....	....T.....	.....A..	..C.....	.....	.....
<i>F. subglutinans</i> (MRC6782)	..G.....	....T.....	.....A..	..C.....	.....	.....
<b>MP-E; Host = Maize</b>						
<i>F. subglutinans</i> (MRC6512)	...C.....	.....A..	..C.....	.....	.....	.....
<i>F. subglutinans</i> (MRC6483)	...C.....	.....A..	..C.....	.....	.....	.....
<b>MP-H; Host = Pine</b>						
<i>F. subglutinans</i> (MRC6213)	.....	.....A..	..C.....	.....	.....	.....
<i>F. subglutinans</i> (MRC6228)	.....	.....A..	..C.....	.....	.....	.....
<b>Host = Mango (1)</b>						
<i>F. subglutinans</i> (MRC7873)	..G.....	.....A..	..C.....	.....	.....	.....
<i>F. subglutinans</i> (MRC7605)	..G.....	.....A..	..C.....	.....	.....	.....
<i>F. subglutinans</i> (MRC7875)	..G.....	.....A..	..C.....	.....	.....	.....
<i>F. subglutinans</i> (MRC7876)	..G.....	.....A..	..C.....	.....	.....	.....
<i>F. subglutinans</i> (MRC7877)	..G.....	.....A..	..C.....	.....	.....	.....
<i>F. subglutinans</i> (MRC2802)	..G.....	.....A..	..C.....	.....	.....	.....
<b>Host = Mango (2)</b>						
<i>F. subglutinans</i> (MRC7038)	.....	.....	.....	.....	.....	.....
<i>F. subglutinans</i> (MRC7037)	.....	.....	.....	.....	.....	.....
<i>F. subglutinans</i> (MRC7034)	.....	.....	.....	.....	.....	.....
<i>F. subglutinans</i> (MRC2730)	.....	.....	.....	.....	.....	.....
<i>F. subglutinans</i> (MRC7035)	.....	.....	.....	.....	.....	.....
<i>F. subglutinans</i> (MRC3479)	.....	.....	.....	.....	.....	.....
<i>F. subglutinans</i> (MRC3477)	.....	.....	.....	.....	.....	.....
<i>F. subglutinans</i> (MRC3478)	.....	.....	.....	.....	.....	.....
<i>F. subglutinans</i> (MRC7559)	.....	.....	.....	.....	.....	.....
<i>F. subglutinans</i> (MRC7560)	.....	.....	.....	.....	.....	.....
<i>F. subglutinans</i> (MRC7561)	.....	.....	.....	.....	.....	.....
<i>F. subglutinans</i> (MRC7562)	.....	.....	.....	.....	.....	.....
<b>MP-G</b>						
<i>F. nygamai</i> (MRC7548)	.....	.....	.....	..C.....	.....	.....
<i>F. nygamai</i> (MRC7549)	.....	.....	.....	..C.....	.....	.....
<b>MP-F</b>						
<i>F. thapsinum</i> (MRC6537)	--.--.....	....T.....	.....	.....	.....	.....
<i>F. thapsinum</i> (MRC6536)	--.--.....	....T.....	.....	.....	.....	.....
<b>MP-A</b>						
<i>F. verticillioides</i> (MRC6155)	.-.....	....T.....	.....	..C.....	.....	.....
<i>F. verticillioides</i> (MRC6191)	.-.....	....T.....	.....	..C.....	.....	.....
<b>MP-B; Host = Sugarcane</b>						
<i>F. subglutinans</i> (MRC6525)	A...GT-..	.....A..	.....	.....	.....	.....
<i>F. subglutinans</i> (MRC6524)	A...GT-..	.....A..	.....	.....	.....	.....
<b>MP-D</b>						
<i>F. proliferatum</i> (MRC6569)	.....	.....	.....	.....	.....	.....
<i>F. proliferatum</i> (MRC6568)	.....	.....	.....	.....	.....	.....
<b>MP-C</b>						
<i>F. fujikuroi</i> (MRC6571)	.....	.....	.....	.....	.....	.....
<i>F. fujikuroi</i> (MRC6570)	.....	.....	.....	.....	.....	.....



	250	260	270	280	290
<i>F. oxysporum</i>	CTCATCCGAA	AGCTCCCTT	CCAGCGTCTG	GTGAGCACCA	C---CAATAT ACATCAA-TC
<b>Host = Pineapple</b>					
<i>F. subglutinans</i> (MRC6783)	.....	.....	.....	..A...T..	----TG.-. ....-C.
<i>F. subglutinans</i> (MRC6782)	.....	.....	.....	..A...T..	----TG.-. ....-C.
<b>MP-E; Host = Maize</b>					
<i>F. subglutinans</i> (MRC6512)	.....	.....C...	.....	..A.....	----TGC-. ....-C.
<i>F. subglutinans</i> (MRC6483)	.....	.....C...	.....	..A.....	----TGC-. ....-C.
<b>MP-H; Host = Pine</b>					
<i>F. subglutinans</i> (MRC6213)	.....	.....C...	.....	..A...T..	----TGC-. ....-C.
<i>F. subglutinans</i> (MRC6228)	.....	.....C...	.....	..A...T..	----TGC-. ....-C.
<b>Host = Mango (1)</b>					
<i>F. subglutinans</i> (MRC7873)	.....	.....	.....	..A...T..	----TG.-. ....-C.
<i>F. subglutinans</i> (MRC7605)	.....	.....	.....	..A...T..	----TG.-. ....-C.
<i>F. subglutinans</i> (MRC7875)	.....	.....	.....	..A...T..	----TG.-. ....-C.
<i>F. subglutinans</i> (MRC7876)	.....	.....	.....	..A...T..	----TG.-. ....-C.
<i>F. subglutinans</i> (MRC7877)	.....	.....	.....	..A...T..	----TG.-. ....-C.
<i>F. subglutinans</i> (MRC2802)	.....	.....	.....	..A...T..	----TG.-. ....-C.
<b>Host = Mango (2)</b>					
<i>F. subglutinans</i> (MRC7038)	.....	.....	.....	..A...T..	----TG.-. ...C.-GG..
<i>F. subglutinans</i> (MRC7037)	.....	.....	.....	..A...T..	----TG.-. ...C.-GG..
<i>F. subglutinans</i> (MRC7034)	.....	.....	.....	..A...T..	----TG.-. ...C.-GG..
<i>F. subglutinans</i> (MRC2730)	.....	.....	.....	..A...T..	----TG.-. ...C.-GG..
<i>F. subglutinans</i> (MRC7035)	.....	.....	.....	..A...T..	----TG.-. ...C.-GG..
<i>F. subglutinans</i> (MRC3479)	.....	.....	.....	..A...T..	----TG.-. ...C.-GG..
<i>F. subglutinans</i> (MRC3477)	.....	.....	.....	..A...T..	----TG.-. ...C.-GG..
<i>F. subglutinans</i> (MRC3478)	.....	.....	.....	..A...T..	----TG.-. ...C.-GG..
<i>F. subglutinans</i> (MRC7559)	.....	.....	.....	..A...T..	----TG.-. ...C.-GG..
<i>F. subglutinans</i> (MRC7560)	.....	.....	.....	..A...T..	----TG.-. ...C.-GG..
<i>F. subglutinans</i> (MRC7561)	.....	.....	.....	..A...T..	----TG.-. ...C.-GG..
<i>F. subglutinans</i> (MRC7562)	.....	.....	.....	..A...T..	----TG.-. ...C.-GG..
<b>MP-G</b>					
<i>F. nygamai</i> (MRC7548)	.....	.....	.....	..A...GT..	----TGC-. ....G.-..
<i>F. nygamai</i> (MRC7549)	.....	.....	.....	..A...GT..	----TGC-. ....G.-..
<b>MP-F</b>					
<i>F. thapsinum</i> (MRC6537)	.....	.....	.....	..A...G... .ATA---	C-. ....-..
<i>F. thapsinum</i> (MRC6536)	.....	.....	.....	..A...G... .ATA---	C-. ....-..
<b>MP-A</b>					
<i>F. verticillioides</i> (MRC6155)	.....T.....	.....	.....	..A...G... .---	TGC-. T.....-C.
<i>F. verticillioides</i> (MRC6191)	.....T.....	.....	.....	..A...G... .---	TGC-. T.....-C.
<b>MP-B; Host = Sugarcane</b>					
<i>F. subglutinans</i> (MRC6525)	.....	.....C...	.....	..A...TT. .-TT.--	C-. ...CT-GCC.
<i>F. subglutinans</i> (MRC6524)	.....	.....C...	.....	..A...TT. .-TT.--	C-. ...CT-GCC.
<b>MP-D</b>					
<i>F. proliferatum</i> (MRC6569)	.....	.....	.....	..A...T.. .---	TGC-. ....T-CG..
<i>F. proliferatum</i> (MRC6568)	.....	.....	.....	..A...T.. .---	TGC-. ....T-CG..
<b>MP-C</b>					
<i>F. fujikuroi</i> (MRC6571)	.....	.....	.....	..A...T.. .---	TGC-. ....T-CG..
<i>F. fujikuroi</i> (MRC6570)	.....	.....	.....	..A...T.. .---	TGC-. ....T-CG..



	310	320	330	340	350
<i>F. oxysporum</i>	AAAC-CTTGA	CAT-ATACTA	ACATGAGACA	AACAGGTTCCG	TGAGATTGCC CAGGACTTCA
<b>Host = Pineapple</b>					
<i>F. subglutinans</i> (MRC6783)	.C-.G.C...	..-C.....	.T..TC....	.....C..	C.....
<i>F. subglutinans</i> (MRC6782)	.C-.G.C...	..-C.....	.T..TC....	.....C..	C.....
<b>MP-E; Host = Maize</b>					
<i>F. subglutinans</i> (MRC6512)	.C-.G.C...	..-C.....	...TT....	.....C..	C.....
<i>F. subglutinans</i> (MRC6483)	.C-.G.C...	..-C.....	...TT....	.....C..	C.....
<b>MP-H; Host = Pine</b>					
<i>F. subglutinans</i> (MRC6213)	.C-.G.C...	..-C.....	...TT....	.....C..	C.....
<i>F. subglutinans</i> (MRC6228)	.C-.G.C...	..-C.....	...TT....	.....C..	C.....
<b>Host = Mango (1)</b>					
<i>F. subglutinans</i> (MRC7873)	.C-.G.C.-.	..-C.....	...TC....	.....C..	C.....
<i>F. subglutinans</i> (MRC7605)	.C-.G.C.-.	..-C.....	...TC....	.....C..	C.....
<i>F. subglutinans</i> (MRC7875)	.C-.G.C.-.	..-C.....	...TC....	.....C..	C.....
<i>F. subglutinans</i> (MRC7876)	.C-.G.C.-.	..-C.....	...TC....	.....C..	C.....
<i>F. subglutinans</i> (MRC7877)	.C-.G.C.-.	..-C.....	...TC....	.....C..	C.....
<i>F. subglutinans</i> (MRC2802)	.C-.G.C.-.	..-C.....	...TC....	.....C..	C.....
<b>Host = Mango (2)</b>					
<i>F. subglutinans</i> (MRC7038)	.CT-G..C..	..-C.C....	...TC....	.....C..	C.....
<i>F. subglutinans</i> (MRC7037)	.CT-G..C..	..-C.C....	...TC....	.....C..	C.....
<i>F. subglutinans</i> (MRC7034)	.CT-G..C..	..-C.C....	...TC....	.....C..	C.....
<i>F. subglutinans</i> (MRC2730)	.CT-G..C..	..-C.C....	...TC....	.....C..	C.....
<i>F. subglutinans</i> (MRC7035)	.CT-G..C..	..-C.C....	...TC....	.....C..	C.....
<i>F. subglutinans</i> (MRC3479)	.CT-G..C..	..-C.C....	...TC....	.....C..	C.....
<i>F. subglutinans</i> (MRC3477)	.CT-G..C..	..-C.C....	...TC....	.....C..	C.....
<i>F. subglutinans</i> (MRC3478)	.CT-G..C..	..-C.C....	...TC....	.....C..	C.....
<i>F. subglutinans</i> (MRC7559)	.CT-G..C..	..-C.C....	...TC....	.....C..	C.....
<i>F. subglutinans</i> (MRC7560)	.CT-G..C..	..-C.C....	...TC....	.....C..	C.....
<i>F. subglutinans</i> (MRC7561)	.CT-G..C..	..-C.C....	...TC....	.....C..	C.....
<i>F. subglutinans</i> (MRC7562)	.CT-G..C..	..-C.C....	...TC....	.....C..	C.....
<b>MP-G</b>					
<i>F. nygamai</i> (MRC7548)	.C-.G.....	..-C.....	...CTC....	.....C..	C.....
<i>F. nygamai</i> (MRC7549)	.C-.G.....	..-C.....	...CTC....	.....C..	C.....
<b>MP-F</b>					
<i>F. thapsinum</i> (MRC6537)	.C-.G.....	..-C.....	...TC..T.	.....C..	..A....T
<i>F. thapsinum</i> (MRC6536)	.C-.G.....	..-C.....	...TC..T.	.....C..	..A....T
<b>MP-A</b>					
<i>F. verticillioides</i> (MRC6155)	.C-.G.C...	..-C.....	...CTT.GT.	.....C..	.....C..
<i>F. verticillioides</i> (MRC6191)	.C-.G.C...	..-C.....	...CTT.GT.	.....C..	.....C..
<b>MP-B; Host = Sugarcane</b>					
<i>F. subglutinans</i> (MRC6525)	.C-.AT....	..G-C.....	...TC....	.....C..	C.....
<i>F. subglutinans</i> (MRC6524)	.C-.AT....	..G-C.....	...TC....	.....C..	C.....
<b>MP-D</b>					
<i>F. proliferatum</i> (MRC6569)	.C-.G.....	..G-C.....	...TC...G	.....C..	C.....
<i>F. proliferatum</i> (MRC6568)	.C-.G.....	..G-C.....	...TC...G	.....C..	C.....
<b>MP-C</b>					
<i>F. fujikuroi</i> (MRC6571)	.C-.G.C...	..-C.....	...TC...G	.....C..	C.....
<i>F. fujikuroi</i> (MRC6570)	.C-.G.C...	..-C.....	...TC...G	.....C..	C.....





	370	380	390	400	410	420
<i>F. oxysporum</i>	AGTCTGATCT	CCGCTTCCAG	TCTTCTGCCA	TCGGTGCTCT	CCAGGAGTCC	GTTGAGTCTT
<b>Host = Pineapple</b>						
<i>F. subglutinans</i> (MRC6783)	.....	.....	..C....	.T.....	.....T	..C.....
<i>F. subglutinans</i> (MRC6782)	.....	.....	..C....	.T.....	.....T	..C.....
<b>MP-E; Host = Maize</b>						
<i>F. subglutinans</i> (MRC6512)	.....	.....	..C....	.....	.....T	.....
<i>F. subglutinans</i> (MRC6483)	.....	.....	..C....	.....	.....T	.....
<b>MP-H; Host = Pine</b>						
<i>F. subglutinans</i> (MRC6213)	...C....	.....	..C....	.....	.....T	..C....T.
<i>F. subglutinans</i> (MRC6228)	...C....	.....	..C....	.....	.....T	..C....T.
<b>Host = Mango (1)</b>						
<i>F. subglutinans</i> (MRC7873)	.....	.....	..C....	.....	.....T	..C.....
<i>F. subglutinans</i> (MRC7605)	.....	.....	..C....	.....	.....T	..C.....
<i>F. subglutinans</i> (MRC7875)	.....	.....	..C....	.....	.....T	..C.....
<i>F. subglutinans</i> (MRC7876)	.....	.....	..C....	.....	.....T	..C.....
<i>F. subglutinans</i> (MRC7877)	.....	.....	..C....	.....	.....T	..C.....
<i>F. subglutinans</i> (MRC2802)	.....	.....	..C....	.....	.....T	..C.....
<b>Host = Mango (2)</b>						
<i>F. subglutinans</i> (MRC7038)	.....	.....	.....	..T.....	.....	.....A.
<i>F. subglutinans</i> (MRC7037)	.....	.....	.....	..T.....	.....	.....A.
<i>F. subglutinans</i> (MRC7034)	.....	.....	.....	..T.....	.....	.....A.
<i>F. subglutinans</i> (MRC2730)	.....	.....	.....	..T.....	.....	.....A.
<i>F. subglutinans</i> (MRC7035)	.....	.....	.....	..T.....	.....	.....A.
<i>F. subglutinans</i> (MRC3479)	.....	.....	.....	..T.....	.....	.....A.
<i>F. subglutinans</i> (MRC3477)	.....	.....	.....	..T.....	.....	.....A.
<i>F. subglutinans</i> (MRC3478)	.....	.....	.....	..T.....	.....	.....A.
<i>F. subglutinans</i> (MRC7559)	.....	.....	.....	..T.....	.....	.....A.
<i>F. subglutinans</i> (MRC7560)	.....	.....	.....	..T.....	.....	.....A.
<i>F. subglutinans</i> (MRC7561)	.....	.....	.....	..T.....	.....	.....A.
<i>F. subglutinans</i> (MRC7562)	.....	.....	.....	..T.....	.....	.....A.
<b>MP-G</b>						
<i>F. nygamai</i> (MRC7548)	.....	.....	.....	.....	.....	..C....T.
<i>F. nygamai</i> (MRC7549)	.....	.....	.....	.....	.....	..C....T.
<b>MP-F</b>						
<i>F. thapsinum</i> (MRC6537)	.....	.....	..C....	.....	A.....	..C....T.
<i>F. thapsinum</i> (MRC6536)	.....	.....	..C....	.....	A.....	..C....T.
<b>MP-A</b>						
<i>F. verticillioides</i> (MRC6155)	.....	.....	.....	.....	.....	..C....T.
<i>F. verticillioides</i> (MRC6191)	.....	.....	.....	.....	.....	..C....T.
<b>MP-B; Host = Sugarcane</b>						
<i>F. subglutinans</i> (MRC6525)	.....	.....	.....	.....	.....	..C.....
<i>F. subglutinans</i> (MRC6524)	.....	.....	.....	.....	.....	..C.....
<b>MP-D</b>						
<i>F. proliferatum</i> (MRC6569)	.....	.....	..C....	.....	.....	..C.....
<i>F. proliferatum</i> (MRC6568)	.....	.....	..C....	.....	.....	..C.....
<b>MP-C</b>						
<i>F. fujikuroi</i> (MRC6571)	.....	.....	..C....	.....	.....	..C.....
<i>F. fujikuroi</i> (MRC6570)	.....	.....	..C....	.....	.....	..C.....



	430	440	450	460	470
<i>F. oxysporum</i>	ACCTCGTCTC	CCTCTTCGAG	GACACCAACC	TCTGCGCCAT	CCATGCCAAG CGT
<b>Host = Pineapple</b>					
<i>F. subglutinans</i> (MRC6783)	.....	..T.....	.....	..C.....	.....
<i>F. subglutinans</i> (MRC6782)	.....	..T.....	.....	..C.....	.....
<b>MP-E; Host = Maize</b>					
<i>F. subglutinans</i> (MRC6512)	.....	..T... ..T.....	..T.....	..C.....	.....
<i>F. subglutinans</i> (MRC6483)	.....	..T... ..T.....	..T.....	..C.....	.....
<b>MP-H; Host = Pine</b>					
<i>F. subglutinans</i> (MRC6213)	.....	..T.....	..T.....	..C.....	.....
<i>F. subglutinans</i> (MRC6228)	.....	..T.....	..T.....	..C.....	.....
<b>Host = Mango (1)</b>					
<i>F. subglutinans</i> (MRC7873)	.....	..T.....	.....	..C.....	.....
<i>F. subglutinans</i> (MRC7605)	.....	..T.....	.....	..C.....	.....
<i>F. subglutinans</i> (MRC7875)	.....	..T.....	.....	..NC.....	.....
<i>F. subglutinans</i> (MRC7876)	.....	..T.....	.....	..NC.....	.....
<i>F. subglutinans</i> (MRC7877)	.....	..T.....	.....	..C.....	.....
<i>F. subglutinans</i> (MRC2802)	.....	..T.....	.....	..C.....	.....
<b>Host = Mango (2)</b>					
<i>F. subglutinans</i> (MRC7038)	.....	..T... ..T.....	..T.....	..C..T.....	.....
<i>F. subglutinans</i> (MRC7037)	.....	..T... ..T.....	..T.....	..C..T.....	.....
<i>F. subglutinans</i> (MRC7034)	.....	..T... ..T.....	..T.....	..C..T.....	.....
<i>F. subglutinans</i> (MRC2730)	.....	..T... ..T.....	..T.....	..C..T.....	.....
<i>F. subglutinans</i> (MRC7035)	.....	..T... ..T.....	..T.....	..C..T.....	.....
<i>F. subglutinans</i> (MRC3479)	.....	..T... ..T.....	..T.....	..C..T.....	.....
<i>F. subglutinans</i> (MRC3477)	.....	..T... ..T.....	..T.....	..C..T.....	.....
<i>F. subglutinans</i> (MRC3478)	.....	..T... ..T.....	..T.....	..C..T.....	.....
<i>F. subglutinans</i> (MRC7559)	.....	..T... ..T.....	..T.....	..C..T.....	.....
<i>F. subglutinans</i> (MRC7560)	.....	..T... ..T.....	..T.....	..C..T.....	.....
<i>F. subglutinans</i> (MRC7561)	.....	..T... ..T.....	..T.....	..C..T.....	.....
<i>F. subglutinans</i> (MRC7562)	.....	..T... ..T.....	..T.....	..C..T.....	.....
<b>MP-G</b>					
<i>F. nygamai</i> (MRC7548)	.....	.....	.....	..C.....	.....
<i>F. nygamai</i> (MRC7549)	.....	.....	.....	..C.....	.....
<b>MP-F</b>					
<i>F. thapsinum</i> (MRC6537)	.....	..T.....	.....	..C.....	.....
<i>F. thapsinum</i> (MRC6536)	.....	..T.....	.....	..C.....	.....
<b>MP-A</b>					
<i>F. verticillioides</i> (MRC6155)	.....	.....	.....	.....G.....	.....
<i>F. verticillioides</i> (MRC6191)	.....	.....	.....	.....G.....	.....
<b>MP-B; Host = Sugarcane</b>					
<i>F. subglutinans</i> (MRC6525)	.....	..T.....	.....	..C.....	.....
<i>F. subglutinans</i> (MRC6524)	.....	..T.....	.....	..C.....	.....
<b>MP-D</b>					
<i>F. proliferatum</i> (MRC6569)	.....	..T..A ..T.....	..T.....	..C.....	.....
<i>F. proliferatum</i> (MRC6568)	.....	..T..A ..T.....	..T.....	..C.....	.....
<b>MP-C</b>					
<i>F. fujikuroi</i> (MRC6571)	.....	..T.....	..T.....	.....	.....
<i>F. fujikuroi</i> (MRC6570)	.....	..T.....	..T.....	.....	.....



### Partial $\beta$ -tubulin (exons 2 and 3)

	10	20	30	40	50	60
<i>F. oxysporum</i>	CTCCGAAAGC	TCGCCGTCAA	CATGGTGCCT	TTCCCTCGTC	TACACTTCTT	CATGGTTGGC
<b>Host = Pineapple</b>						
<i>F. subglutinans</i> f.sp. ananas	.....	.....	.....	.....	.....	.....
<b>MP-H; Host = Pine</b>						
<i>F. subglutinans</i> f.sp. pini	.....	.....	.....	.....	.....	.....
<b>MP-E; Host = Maize</b>						
<i>F. subglutinans</i>	.....	.....	.....	.....	.....	.....
<b>Host = Mango (1)</b>						
<i>F. subglutinans</i> (MRC7877)	.....	.....	.....	.....	.....	.....
<b>Host = Mango (2)</b>						
<i>F. subglutinans</i> (MRC3478)	.....	.....	.....	.....	.....	.....C...
<i>Fusarium</i> sp. (NRRL25226)	.....	.....	.....	.....	.....	.....C...
<b>MP-B; Host = Sugarcane</b>						
<i>F. subglutinans</i>	.....	.....T.....	.....	.....C.....	.....	.....C...
<b>MP-G</b>						
<i>F. nygamai</i>	.....	.....	.....	.....	.....	.....
<b>MP-F</b>						
<i>F. thapsinum</i>	.....	.....	.....	.....	.....	.....
<b>MP-A</b>						
<i>F. verticillioides</i>	.....	.....	.....	.....	.....	.....A
<b>MP-C</b>						
<i>F. fujikuroi</i>	.....	.....	.....	.....	.....T.....	.....C...
<b>MP-D</b>						
<i>F. proliferatum</i>	.....	.....	.....	.....	.....	.....C...
<i>F. succisae</i>	.....	.....	.....	.....	.....	.....
<i>Fusarium</i> sp. (NRRL25346)	.....	.....	.....	.....	.....	.....
<i>Fusarium</i> sp. (NRRL25807)	.....	.....	.....	.....	.....	.....
<i>Fusarium</i> sp. (NRRL25195)	n.....	.....	.....	.....	.....	.....

	70	80	90	100	110	120
<i>F. oxysporum</i>	TTTGCTCCTC	TGACCAGCCG	TGGTGCTCAC	TCTTTCCGCG	CAGTCAGCGT	TCCTGAGTTG
<b>Host = Pineapple</b>						
<i>F. subglutinans</i> f.sp. ananas	.....C.....	.....	.....	.....	.....T.....	.....
<b>MP-H; Host = Pine</b>						
<i>F. subglutinans</i> f.sp. pini	.....C.....	.....	.....	.....	.....T.....	.....
<b>MP-E; Host = Maize</b>						
<i>F. subglutinans</i>	.....C.....	.....	.....	.....	.....T.....	.....
<b>Host = Mango (1)</b>						
<i>F. subglutinans</i> (MRC7877)	.....C.....	.....	.....	.....	.....T.....	.....
<b>Host = Mango (2)</b>						
<i>F. subglutinans</i> (MRC3478)	.....	.....	.....	.....	.....T.....	.....
<i>Fusarium</i> sp. (NRRL25226)	.....	.....	.....	.....	.....T.....	.....
<b>MP-B; Host = Sugarcane</b>						
<i>F. subglutinans</i>	.....	.....	.....	.....	.....T.....	.....
<b>MP-G</b>						
<i>F. nygamai</i>	.....	.....	.....	.....	.....T.....	.....C.....
<b>MP-F</b>						
<i>F. thapsinum</i>	.....	.....	.....	.....	.....T.....	.....
<b>MP-A</b>						
<i>F. verticillioides</i>	.....	.....	.....	.....	.....T.....	.....
<b>MP-C</b>						
<i>F. fujikuroi</i>	.....A.....	.....	.....	.....	.....T.....	.....
<b>MP-D</b>						
<i>F. proliferatum</i>	.....	.....	.....	.....	.....T.....	.....
<i>F. succisae</i>	.....C.....	.....	.....	.....	.....T.....	.....
<i>Fusarium</i> sp. (NRRL25346)	.....C.....	.....	.....	.....	.....T.....	.....
<i>Fusarium</i> sp. (NRRL25807)	.....C.....	.....	.....	.....	.....T.....	.....
<i>Fusarium</i> sp. (NRRL25195)	.....C.....	.....	.....	.....	.....T.....	.....



	130	140	150	160	170	180
<i>F.oxysporum</i>	ACCCAACAGA	TGTTTCGACCC	TAAGAACATG	ATGGCCGCTT	CGGACTTCCG	CAACGGTCCG
<b>Host = Pineapple</b>						
<i>F.subglutinans</i> f.sp. <i>ananas</i>	.....	.....C.....	.....T.....	.....A.....	.....	.....
<b>MP-H; Host = Pine</b>						
<i>F.subglutinans</i> f.sp. <i>pini</i>	.....	.....C.....	.....T.....	.....A.....	.....	.....
<b>MP-E; Host = Maize</b>						
<i>F.subglutinans</i>	.....	.....C.....	.....T.....	.....A.....	.....	.....
<b>Host = Mango (1)</b>						
<i>F.subglutinans</i> (MRC7877)	.....	.....C.....	.....T.....	.....A.....	.....	.....
<b>Host = Mango (2)</b>						
<i>F.subglutinans</i> (MRC3478)	.....	.....C.....	.....T.....	.....	.....	.....
<i>Fusarium</i> sp. (NRRL25226)	.....	.....C.....	.....T.....	.....	.....	.....
<b>MP-B; Host = Sugarcane</b>						
<i>F.subglutinans</i>	.....	.....C.....	.....T.....	.....	.....T.....	.....
<b>MP-G</b>						
<i>F.nygamai</i>	.....	.....C.....	.....T.....	.....	.....T.....	.....
<b>MP-F</b>						
<i>F.thapsinum</i>	.....	.....C.....	.....T.....	.....	.....T.....	.....
<b>MP-A</b>						
<i>F.verticillioides</i>	.....	.....C.....	.....T.....	.....	.....T.....	.....
<b>MP-C</b>						
<i>F.fujikuroi</i>	.....	.....C.....	.....T.....	.....	.....	.....
<b>MP-D</b>						
<i>F.proliferatum</i>	.....	.....C.....	.....T.....	.....	.....	.....
<i>F.succisae</i>	.....	.....C.....	.....T.....	.....A.....	.....	.....
<i>Fusarium</i> sp. (NRRL25346)	.....	.....C.....	.....T.....	.....A.....	.....	.....
<i>Fusarium</i> sp. (NRRL25807)	.....	.....C.....	.....T.....	.....A.....	.....	.....
<i>Fusarium</i> sp. (NRRL25195)	.....	.....C.....	.....T.....	.....A.....	.....	.....

	190	200	210	220	230	240
<i>F.oxysporum</i>	TACCTGACCT	GCTCGnCAT	TTTGTGAGTG	AACCCGATTT	TGCACATAGA	AATTACTTGC
<b>Host = Pineapple</b>						
<i>F.subglutinans</i> f.sp. <i>ananas</i>	.....	.....C.....	.....T.T...G..	.....G..	G...T....	.....
<b>MP-H; Host = Pine</b>						
<i>F.subglutinans</i> f.sp. <i>pini</i>	.....	.....C.....	.....T.T...A..	.....A..G..	G...T....	.....
<b>MP-E; Host = Maize</b>						
<i>F.subglutinans</i>	.....	.....TC...G..	.....T.T..GA.	.....G.T	G...T....	.....
<b>Host = Mango (1)</b>						
<i>F.subglutinans</i> (MRC7877)	.....	.....C.....	.....T.T....	.....G..	G...T....	.....
<b>Host = Mango (2)</b>						
<i>F.subglutinans</i> (MRC3478)	.....	.....C.....	.....T.....	.....GAT	..CA.T..A.	.....
<i>Fusarium</i> sp. (NRRL25226)	.....	.....C.....	.....T.....	.....GAT	..CA.T..A.	.....
<b>MP-B; Host = Sugarcane</b>						
<i>F.subglutinans</i>	.....	.....C.....	.....T.....	.....GAG	..C..T..A.	.....
<b>MP-G</b>						
<i>F.nygamai</i>	.....	.....C.....	.....	.....G..	.....T..A.	.....
<b>MP-F</b>						
<i>F.thapsinum</i>	.....	.....C.....	.....	.....A..T.CG..	.....T..A.	.....
<b>MP-A</b>						
<i>F.verticillioides</i>	.....	.....A.C...	.....	.....G..G..	.....T..A.	.....
<b>MP-C</b>						
<i>F.fujikuroi</i>	.....	.....C.....	.....T.....	.....G.T	..CA.T..A.	.....
<b>MP-D</b>						
<i>F.proliferatum</i>	.....	.....C.....	.....T.....	.....G.T	..CA.T..A.	.....
<i>F.succisae</i>	.....	.....C.....	.....T.T....	.....A..G..	G...T....	.....
<i>Fusarium</i> sp. (NRRL25346)	.....	.....C.....	.....T.T....	.....G..	C...T....	.....
<i>Fusarium</i> sp. (NRRL25807)	.....	.....C.....	.....T.T....	.....G..	G...T....	.....
<i>Fusarium</i> sp. (NRRL25195)	.....	.....C.....	.....T.T....	C.....G..	G...T....	.....



	250	260	270	280	290	300
<i>F.oxysporum</i>	TAACTTTATA	CAGCCGTGGC	CGTGTGCGCTA	TGAAGGAGGT	CGAGGACCAG	ATGCGCAACG
<b>Host = Pineapple</b>						
<i>F.subglutinans</i> f.sp. ananas	....G..C..	.....	..G.....	.....	.....	.....T.
<b>MP-H; Host = Pine</b>						
<i>F.subglutinans</i> f.sp. pini	....G..C..	.....	.....	.....	.....	.....T.
<b>MP-E; Host = Maize</b>						
<i>F.subglutinans</i>	....G..C..	.....	.....	.....	.....	.....T.
<b>Host = Mango (1)</b>						
<i>F.subglutinans</i> (MRC7877)	....G..C..	.....	..G.....	.....	.....	.....T.
<b>Host = Mango (2)</b>						
<i>F.subglutinans</i> (MRC3478)	.G.....AC	.....	.....	.....	.....	.....
<i>Fusarium</i> sp.(NRRL25226)	.G.....AC	.....	.....	.....	.....	.....
<b>MP-B; Host = Sugarcane</b>						
<i>F.subglutinans</i>	.G.....C.	T.....	.....	.....	.....	.....
<b>MP-G</b>						
<i>F.nygamai</i>	.G....GC.	.....	.....	.....	.....	.....
<b>MP-F</b>						
<i>F.thapsinum</i>	.G....GC.	.....	.....	.....	.....T.....	.....
<b>MP-A</b>						
<i>F.verticillioides</i>	.G....GA.	.....	.....	.....	.....T.....	.....
<b>MP-C</b>						
<i>F.fujikuroi</i>	.G.....C	.....	.....	.....	.....	.....
<b>MP-D</b>						
<i>F.proliferatum</i>	.G.....C	.....	.....	.....	.....	.....
<i>F.succisae</i>	....G..C..	.....	.....	.....	.....	.....T.
<i>Fusarium</i> sp.(NRRL25346)	....G..C..	.....	.....	.....	.....	.....T.
<i>Fusarium</i> sp.(NRRL25807)	....G..C..	.....	.....	.....	.....	.....T.
<i>Fusarium</i> sp.(NRRL25195)	....G..C..	.....	..G.....	.....	.....	.....T.

	310	320	330	338
<i>F.oxysporum</i>	TCCAGAACAA	GAACTCTTCT	TACTTCGTTG	AATGGATT
<b>Host = Pineapple</b>				
<i>F.subglutinans</i> f.sp. ananas	.....G..	.....	.....	.....
<b>MP-H; Host = Pine</b>				
<i>F.subglutinans</i> f.sp. pini	.....G..	.....	.....	.....
<b>MP-E; Host = Maize</b>				
<i>F.subglutinans</i>	.....G..	.....	.....	.....
<b>Host = Mango (1)</b>				
<i>F.subglutinans</i> (MRC7877)	.....G..	.....	.....	.....
<b>Host = Mango (2)</b>				
<i>F.subglutinans</i> (MRC3478)	.....G..	.....G..	.....	.....
<i>Fusarium</i> sp.(NRRL25226)	.....G..	.....G..	.....	.....
<b>MP-B; Host = Sugarcane</b>				
<i>F.subglutinans</i>	.....GG..	.....	.....	.....
<b>MP-G</b>				
<i>F.nygamai</i>	.....G..	.....	.....	.....
<b>MP-F</b>				
<i>F.thapsinum</i>	.....G..	.....	.....	.....
<b>MP-A</b>				
<i>F.verticillioides</i>	.....	.....	.....	.....
<b>MP-C</b>				
<i>F.fujikuroi</i>	.....G..	.....G..	.....	.....
<b>MP-D</b>				
<i>F.proliferatum</i>	.....G..	.....G..	.....	.....
<i>F.succisae</i>	.....G..	.....	.....T.....	.....
<i>Fusarium</i> sp.(NRRL25346)	.....G..	.....	.....T.....	.....nn
<i>Fusarium</i> sp.(NRRL25807)	.....G..	.....	.....T.....	.....
<i>Fusarium</i> sp.(NRRL25195)	.....G..	n.....	.....C.	.....





**Partial  $\beta$ -tubulin (exons 4 and 5)**

	10	20	30	40	50	60
<i>F.oxysporum</i>	GCCCCTGATT	CTA-----CC	CCGCTGGGCG	GTGGCAGCTC	AACGACAATG	CACGATA---
<b>Host = Pineapple</b>						
<i>F.subglutinans</i> f.sp. ananas	.....	-----	.....	.....	.....	-----
<b>MP-H; Host = Pine</b>						
<i>F.subglutinans</i> f.sp. pini	.....	-----	.....	.....	.....	-----
<b>MP-E; Host = Maize</b>						
<i>F.subglutinans</i>	.....	-----	.....	.....	.....	-----
<b>Host = Mango (1)</b>						
<i>F.subglutinans</i> (MRC7877)	.....	-----	.....	.....	.....	-----
<b>Host = Mango (2)</b>						
<i>F.subglutinans</i> (MRC3478)	.....	-----	.....	.....	T..	-----
<i>Fusarium</i> sp. (NRRL25226)	.....	-----	.....	.....	T..	-----
<b>MP-B; Host = Sugarcane</b>						
<i>F.subglutinans</i>	.....	-----	.....	.....	G.....T..	-----
<b>MP-G</b>						
<i>F.nygamai</i>	.....	-----	.....	.....	G.....	T...GAT
<b>MP-A</b>						
<i>F.verticillioides</i>	.....	-----	.....	.....	.....	T...GAT
<b>MP-F</b>						
<i>F.thapsinum</i>	.....	TTCTA..	.....	.....	.....	T...GAT
<b>MP-C</b>						
<i>F.fujikuroi</i>	.....	-----	.....	T..	.....	T..
<b>MP-D</b>						
<i>F.proliferatum</i>	.....	-----	.....	T..	.....	T..
<i>F.succisae</i>	.....	-----	.....	.....	.....	-----
<i>Fusarium</i> sp. (NRRL25346)	.....	-----	.....	.....	.....	-----
<i>Fusarium</i> sp. (NRRL25807)	.....	-----	.....	.....	.....	-----
<i>Fusarium</i> sp. (NRRL25195)	.....	-----	.....	.....	.....	-----

	70	80	90	100	110	120
<i>F.oxysporum</i>	-GCTAGCAGC	TTTACCATAC	CTTCTGTCAA	GAC-AAGAAG	CTAATCAGAT	CTCTTCTCTA
<b>Host = Pineapple</b>						
<i>F.subglutinans</i> f.sp. ananas	-.T.....	...AT...	.....T..	..TG.....	.....	..T.....
<b>MP-H; Host = Pine</b>						
<i>F.subglutinans</i> f.sp. pini	-.....	...AT...	.....	T.TG.....	.....	..T.....G
<b>MP-E; Host = Maize</b>						
<i>F.subglutinans</i>	-.....	...AA-	.....	..TG.....	.....	..T.....G
<b>Host = Mango (1)</b>						
<i>F.subglutinans</i> (MRC7877)	-.....	...AT...	.....	..TG.....	.....	..T.....G
<b>Host = Mango (2)</b>						
<i>F.subglutinans</i> (MRC3478)	-.....	...A.C..	.....	..G.....	.....	..T.....
<i>Fusarium</i> sp. (NRRL25226)	-.....	...A.C..	.....	..G.....	.....	..T.....
<b>MP-B; Host = Sugarcane</b>						
<i>F.subglutinans</i>	-.....	...A.C..	.....	..G.T...	.....	..T.....
<b>MP-G</b>						
<i>F.nygamai</i>	A..C.....	...CA...	.....	..G.....	.....	..T.....
<b>MP-A</b>						
<i>F.verticillioides</i>	A.....	...CA...	.....	..G.....	.....	..T.....
<b>MP-F</b>						
<i>F.thapsinum</i>	A.....	...CA...	.....	..G..A...	.....	..T.....
<b>MP-C</b>						
<i>F.fujikuroi</i>	-.....	...A.C..	..A..C...	..G.....	.....	A.T.....
<b>MP-D</b>						
<i>F.proliferatum</i>	-.....	...A.C..	.....	..G.....	.....	..T.....
<i>F.succisae</i>	-.....	...AT...	.....	T.TG.....	.....	..T.....G
<i>Fusarium</i> sp. (NRRL25346)	-.....	...AT...	.....	..TG.....	.....	..T.CG...G
<i>Fusarium</i> sp. (NRRL25807)	-.....	...AT...	.....	T.TG.....	.....	..T.....G
<i>Fusarium</i> sp. (NRRL25195)	-.....	...AT...	.....	..TG.....	.....	..T.....G



	130	140	150	160	170	180
<i>F.oxysporum</i>	CAATAGGTTC	ACCTCCAGAC	CGGTCAGTGC	GTAAGTGCTC	ATCGCTTCCT	CAACGTCGCA
<b>Host = Pineapple</b>						
<i>F.subglutinans</i> f.sp. <i>ananas</i>	.G.....					.G.....
<b>MP-H; Host = Pine</b>						
<i>F.subglutinans</i> f.sp. <i>pini</i>	.G.....					.G.....
<b>MP-E; Host = Maize</b>						
<i>F.subglutinans</i>	.G.....					.G.....
<b>Host = Mango (1)</b>						
<i>F.subglutinans</i> (MRC7877)	.G.....					.G.....
<b>Host = Mango (2)</b>						
<i>F.subglutinans</i> (MRC3478)	.G.....					
<i>Fusarium</i> sp. (NRRL25226)	.G.....					
<b>MP-B; Host = Sugarcane</b>						
<i>F.subglutinans</i>	.G.....					
<b>MP-G</b>						
<i>F.nygamai</i>	.G.....					
<b>MP-A</b>						
<i>F.verticillioides</i>	.G.....					.G.....
<b>MP-F</b>						
<i>F.thapsinum</i>	.G.....					
<b>MP-C</b>						
<i>F.fujikuroi</i>	.G.....					
<b>MP-D</b>						
<i>F.proliferatum</i>	.G.....					
<i>F.succisae</i>	.G.....					.G.....
<i>Fusarium</i> sp. (NRRL25346)	.G.....					.G.....
<i>Fusarium</i> sp. (NRRL25807)	.G.....					.G.....
<i>Fusarium</i> sp. (NRRL25195)	.G.....					.G.....

	190	200	210	220	230	240
<i>F.oxysporum</i>	TGCGGGGGA-	TGCTCACAAT	GTTTATCAGG	GTAACCAAAT	CGGTGCTGCT	TTCTGGCAAA
<b>Host = Pineapple</b>						
<i>F.subglutinans</i> f.sp. <i>ananas</i>	..T.A....-				T.....	
<b>MP-H; Host = Pine</b>						
<i>F.subglutinans</i> f.sp. <i>pini</i>	..T.A....-	.....G..			T.....	
<b>MP-E; Host = Maize</b>						
<i>F.subglutinans</i>	..T.....-	.....G..			T.....	
<b>Host = Mango (1)</b>						
<i>F.subglutinans</i> (MRC7877)	..T.A....-	.....G..			T.....	
<b>Host = Mango (2)</b>						
<i>F.subglutinans</i> (MRC3478)	.....-	.....C			T.....	
<i>Fusarium</i> sp. (NRRL25226)	.....-	.....C			T.....	
<b>MP-B; Host = Sugarcane</b>						
<i>F.subglutinans</i>	..G.....-	.....C			T.....	
<b>MP-G</b>						
<i>F.nygamai</i>	.....-	.A..T..G.	...G.....		T.....	
<b>MP-A</b>						
<i>F.verticillioides</i>	..A....GA	.A..T..G.			T.....	
<b>MP-F</b>						
<i>F.thapsinum</i>	.....-	.A.....G.			T.....	
<b>MP-C</b>						
<i>F.fujikuroi</i>	..G.....-	.....C			T.....	
<b>MP-D</b>						
<i>F.proliferatum</i>	.....-	.....C			T.....	
<i>F.succisae</i>	..T.A....-	.....G..			T.....	
<i>Fusarium</i> sp. (NRRL25346)	..T.A....-	.....G..			T.....	
<i>Fusarium</i> sp. (NRRL25807)	..T.A....-	.....G..			T.....	
<i>Fusarium</i> sp. (NRRL25195)	..T.A....-	.....G..			T.....	



	250	260	270	280	290	300
<i>F.oxysporum</i>	CCATCTCTGG	CGAGCACGGC	CTCGACAGCA	ATGGTGTCTA	CAACGGTACC	TCCGAGCTCC
<b>Host = Pineapple</b>						
<i>F.subglutinans</i> f.sp. <i>ananas</i>	.....	.....	.....	.....	.....	.....
<b>MP-H; Host = Pine</b>						
<i>F.subglutinans</i> f.sp. <i>pini</i>	.....	.....	.....	.....	.....	.....
<b>MP-E; Host = Maize</b>						
<i>F.subglutinans</i>	.....	.....	.....	.....	.....	.....
<b>Host = Mango (1)</b>						
<i>F.subglutinans</i> (MRC7877)	.....	.....	.....	.....	.....	.....
<b>Host = Mango (2)</b>						
<i>F.subglutinans</i> (MRC3478)	.....	.....	.....	.....	.....	.....
<i>Fusarium</i> sp.(NRRL25226)	.....	.....	.....	.....	.....	.....
<b>MP-B; Host = Sugarcane</b>						
<i>F.subglutinans</i>	.....	.....	.....	.....	.....	.....
<b>MP-G</b>						
<i>F.nygamai</i>	.....	.....	.....	.....	.....	T.
<b>MP-A</b>						
<i>F.verticillioides</i>	.....	.....	.....	.....	T.....	T.
<b>MP-F</b>						
<i>F.thapsinum</i>	.....	.....	.....	.....	.....	T.
<b>MP-C</b>						
<i>F.fujikuroi</i>	.....	.....	.....	.....	.....	.....
<b>MP-D</b>						
<i>F.proliferatum</i>	.....	.....	.....	.....	.....	.....
<i>F.succisae</i>	.....	.....	.....	.....	.....	.....
<i>Fusarium</i> sp.(NRRL25346)	.....	.....	.....	.....	.....	.....
<i>Fusarium</i> sp.(NRRL25807)	.....	.....	.....	.....	.....	.....
<i>Fusarium</i> sp.(NRRL25195)	.....	.....	.....	.....	.....	.....

	310	320	330	340	350	360
<i>F.oxysporum</i>	AGCTCGAGCG	CATGAGTGTC	TACTTCAACG	AGGTATGTAT	TAACAGTCAA	TGCCAAGAAT
<b>Host = Pineapple</b>						
<i>F.subglutinans</i> f.sp. <i>ananas</i>	.....	T.....	.....	.....C..	.....	.A.....
<b>MP-H; Host = Pine</b>						
<i>F.subglutinans</i> f.sp. <i>pini</i>	.....	T.....	.....	.....CT.	.....	.....
<b>MP-E; Host = Maize</b>						
<i>F.subglutinans</i>	.....	T.....	.....	.....CT.	.....	.....
<b>Host = Mango (1)</b>						
<i>F.subglutinans</i> (MRC7877)	.....	T.....	.....	.....C..	.....	.....
<b>Host = Mango (2)</b>						
<i>F.subglutinans</i> (MRC3478)	.....	.....	.....	.....CC.	.....	.....T...
<i>Fusarium</i> sp.(NRRL25226)	.....	.....	.....	.....CC.	.....	.....T...
<b>MP-B; Host = Sugarcane</b>						
<i>F.subglutinans</i>	.....	.....	.....	.....C..	.....	.....T...
<b>MP-G</b>						
<i>F.nygamai</i>	.....	.....T	.....	.....C..	..G.....	..T...G.
<b>MP-A</b>						
<i>F.verticillioides</i>	.....	.....T	.....	.....C..	..G.....	..T...G.
<b>MP-F</b>						
<i>F.thapsinum</i>	.....	.....T	.....	.....	..G...T..	..T...G.
<b>MP-C</b>						
<i>F.fujikuroi</i>	.....	.....	.....	.....CC.	.....	.....T...
<b>MP-D</b>						
<i>F.proliferatum</i>	.....	.....	.....	.....CC.	.....	.....T...
<i>F.succisae</i>	.....	T.....	.....	.....CT.	.....	.....
<i>Fusarium</i> sp.(NRRL25346)	.....	T.....	.....	.....C..	.....	.....
<i>Fusarium</i> sp.(NRRL25807)	.....	T.....	.....	.....CT.	.....	.....
<i>Fusarium</i> sp.(NRRL25195)	.....	T.....	.....	.....C..	.....	.....



	370	380	390	400	410	420
<i>F.oxysporum</i>	TCCCAAGCTC	ACACAACACTAG	GCCTCTGGCA	ACAAGTATGT	TCCCCGAGCC	GTCTCGTCCG
<b>Host = Pineapple</b>						
<i>F.subglutinans</i> f.sp. <i>ananas</i>	.....	.....	.....	.....	.....	.....
<b>MP-H; Host = Pine</b>				.		
<i>F.subglutinans</i> f.sp. <i>pini</i>	.....	...G.....	.....	.....	.....	.....
<b>MP-E; Host = Maize</b>						
<i>F.subglutinans</i>	.....	.....	.....	.....	.....	.....
<b>Host = Mango (1)</b>						
<i>F.subglutinans</i> (MRC7877)	.....	.....	.....	.....	.....	.....
<b>Host = Mango (2)</b>						
<i>F.subglutinans</i> (MRC3478)	-.....	.....	.....	.....	.....	.....
<i>Fusarium</i> sp. (NRRL25226)	C.....	.....	.....	.....	.....	.....
<b>MP-B; Host = Sugarcane</b>						
<i>F.subglutinans</i>	.....	.....	.....	.....	.....	.....
<b>MP-G</b>						
<i>F.nygamai</i>	.....	...T...T.....	.....	.....	.....	.....
<b>MP-A</b>						
<i>F.verticillioides</i>	..A..C.....	...T.....	.....	.....	.....	.....
<b>MP-F</b>						
<i>F.thapsinum</i>	.....	...T.....	.....	.....	.....	.....
<b>MP-C</b>						
<i>F.fujikuroi</i>	C.....	.....	.....	.....	.....	.....
<b>MP-D</b>						
<i>F.proliferatum</i>	C.A.....	.....	.....	.....	.....	.....
<i>F.succisae</i>	.....	.....	.....	.....	.....	.....
<i>Fusarium</i> sp. (NRRL25346)	.....	.....	.....	.....	.....	.....
<i>Fusarium</i> sp. (NRRL25807)	.....	.....	.....	.....	.....	.....
<i>Fusarium</i> sp. (NRRL25195)	.....	.....	.....	.....	.....	.....

	430	440	450	460	470
<i>F.oxysporum</i>	ATCTTGAGCC	TGGTACCATG	GACGCCGTCC	GTGCTGGTCC	CTTCGGTCAG CTCTT
<b>Host = Pineapple</b>					
<i>F.subglutinans</i> f.sp. <i>ananas</i>	.....	.....	.....T.	.A.....	.....
<b>MP-H; Host = Pine</b>					
<i>F.subglutinans</i> f.sp. <i>pini</i>	.....	.....	.....	.A.....	.....
<b>MP-E; Host = Maize</b>					
<i>F.subglutinans</i>	.....	.....	.....	.A.....	.....
<b>Host = Mango (1)</b>					
<i>F.subglutinans</i> (MRC7877)	.....	...C.....	.....	.A.....	T.....
<b>Host = Mango (2)</b>					
<i>F.subglutinans</i> (MRC3478)	.....	.....	...T...	.....	.....
<i>Fusarium</i> sp. (NRRL25226)	.....	.....	...T...	.....	.....
<b>MP-B; Host = Sugarcane</b>					
<i>F.subglutinans</i>	.....	.....	.....	.....	.....
<b>MP-G</b>					
<i>F.nygamai</i>	...C.....	.....	.....	.....	.....
<b>MP-A</b>					
<i>F.verticillioides</i>	.C..C.....	.....	.....	.....	.....
<b>MP-F</b>					
<i>F.thapsinum</i>	...C.....	.....	.....	...C.....	.....
<b>MP-C</b>					
<i>F.fujikuroi</i>	.....	.....	...T...	.....	.....
<b>MP-D</b>					
<i>F.proliferatum</i>	.....	.....	...T...	.....	.....
<i>F.succisae</i>	.....	.....	.....	.A.....	.....
<i>Fusarium</i> sp. (NRRL25346)	.....	.....	.....	.A.....	.....
<i>Fusarium</i> sp. (NRRL25807)	.....	.....	.....	.A.....	.....
<i>Fusarium</i> sp. (NRRL25195)	.....	.....	.....	.A.....	...T..

## APPENDIX 4

Aligned calmodulin,  $\beta$ -tubulin and mitochondrial ribosomal small subunit (mtSSU) DNA sequences for selected *Fusarium* strains in the *Gibberella fujikuroi* complex. These sequences were used to show that *F. subglutinans* strains from teosinte, are conspecific with *G. fujikuroi* mating population E (MP-E) (Chapter 5 of this thesis). Nucleotides similar to those of *F. subglutinans* isolate Fst10 are indicated as dots, whereas nucleotide deletions are indicated by vertical lines (-).

### Calmodulin

	10	20	30	40	50	60
<b>Host = Teosinte</b>						
<i>F. subglutinans</i> (Fst10)	GAAGCTGTCG	CTAACCTCTT	TATCCAGGAC	AAGGATGGCG	ATGGTGAGTG	ATGCTCCCCCT
<i>F. subglutinans</i> (Fst26)	.....	.....	.....	.....	.....	.....
<i>F. subglutinans</i> (Fst40)	.....	.....	.....	.....	.....	.....
<i>F. subglutinans</i> (Fst51)	.....	.....	.....	.....	.....	.....
<b>MP-E; Host = Maize</b>						
<i>F. subglutinans</i> (MRC714)	.....	.....	.....	.....	.....	.....
<i>F. subglutinans</i> (MRC756)	.....	.....	.....	.....	.....	.....
<i>F. subglutinans</i> (MRC1084)	.....	.....	.....	.....	.....	.....
<i>F. subglutinans</i> (MRC6483)	.....	.....	.....	.....	.....	.....
<i>F. subglutinans</i> (MRC6512)	.....	.....	.....	.....	.....	.....
<b>MP-H; Host = Pine</b>						
<i>F. subglutinans</i> (MRC6213)	.....	.....	..GT.....	.....	.....	.....
<i>F. subglutinans</i> (MRC7488)	.....	.....	..GT.....	.....	.....	.....
<i>F. bactridioides</i>	.....	.....	.....	.....	.....	.....
<i>Fusarium</i> sp. (NRRL25622)	.....	.....	.....	.....	.....	.....
<i>F. anthophilum</i>	.....	.....	..GT.....	.....	.....	.....
<i>F. succisae</i>	.....	.....	..GT.....	.....	.....	.....
<i>F. bulbicola</i>	.....	.....	..GT.....	.....	.....	.....
<i>Fusarium</i> sp. (NRRL25623)	.....	.....	..GT.....	.....	.....	.....
<i>Fusarium</i> sp. (NRRL29123)	.....	.....	..GT.....	.....	.....	.....
<i>Fusarium</i> sp. (NRRL29124)	.....	.....	..GT.....	.....	.....	.....
<i>F. guttiforme</i>	.....	.....	..G.....	.....	.....	.....
<i>F. begoniae</i>	.....	.....	..GT.....	.....	.....	.....
<i>F. fujikuroi</i> (MP-C)	.....	.....C.....	..GT.....	.....	.....	.....
<i>F. proliferatum</i> (MP-D)	.....	.....C.....	..AT.....	.....	.....	.....
<i>F. sacchari</i> (MP-B)	.....	.....	C..GT.....	.....	.....	.....-.....-
<i>F. thapsinum</i> (MP-F)	.....	.....	..GT.....	.....	.....	.....
<i>F. verticillioides</i> (MP-A)	.....	.....	..GT.....	.....	.....	.....
<i>F. nygamai</i> (MP-G)	.....	.....	..GT.....	.....	.....	.....
<i>F. inflexum</i>	.....	.....	..GT.....	.....	.....	.....





70 80 90 100 110 120

**Host = Teosinte**

*F. subglutinans* (Fst10) TTCCGCGA-T GTTCTTTCGT TGGCCCCGTG CGAAACCCAA A-TCGATCCA ACAAAGCATG  
*F. subglutinans* (Fst26) .....- .....  
*F. subglutinans* (Fst40) .....- .....  
*F. subglutinans* (Fst51) .....- .....

**MP-E; Host = Maize**

*F. subglutinans* (MRC714) .....- .....  
*F. subglutinans* (MRC756) .....- .....  
*F. subglutinans* (MRC1084) .....- .....  
*F. subglutinans* (MRC6483) .....- .....  
*F. subglutinans* (MRC6512) .....- .....

**MP-H; Host = Pine**

*F. subglutinans* (MRC6213) .....- .....  
*F. subglutinans* (MRC7488) .....- .....  
*F. bactridioides* .....- ..... T.....  
*Fusarium* sp. (NRRL25622) .....- .....  
*F. anthophilum* .....- .....  
*F. succisae* .....- .....  
*F. bulbicola* .....- .....  
*Fusarium* sp. (NRRL25623) .....- ..... G.....  
*Fusarium* sp. (NRRL29123) .....- .....  
*Fusarium* sp. (NRRL29124) .....- ..... G.....  
*F. guttiforme* .....- ..... G.....  
*F. begoniae* .....- ..... G.....  
*F. fujikuroi* (MP-C) ..... C.A- ..... A.....  
*F. proliferatum* (MP-D) ..... C.A- ..... A.....  
*F. sacchari* (MP-B) ... T.. C.G- ..... G. .... C. .... - .....  
*F. thapsinum* (MP-F) ..... - ..... C ..... G- .....  
*F. verticillioides* (MP-A) .C.T. .... - ..... C. .... - .....  
*F. nygamai* (MP-G) .C. .... - ..... C. .... - .....  
*F. inflexum* .....- ..... - .....

130 140 150 160 170 180

**Host = Teosinte**

*F. subglutinans* (Fst10) CATCAGACCA CTATAATCCT CTACATCTCT GTCTATGCGA TATTCTTAAA TCGAAAGCAT  
*F. subglutinans* (Fst26) .....  
*F. subglutinans* (Fst40) .....  
*F. subglutinans* (Fst51) .....

**MP-E; Host = Maize**

*F. subglutinans* (MRC714) .....  
*F. subglutinans* (MRC756) .....  
*F. subglutinans* (MRC1084) .....  
*F. subglutinans* (MRC6483) .....  
*F. subglutinans* (MRC6512) .....

**MP-H; Host = Pine**

*F. subglutinans* (MRC6213) ..... A. .... C.....  
*F. subglutinans* (MRC7488) ..... A. .... C.....  
*F. bactridioides* .....  
*Fusarium* sp. (NRRL25622) .....  
*F. anthophilum* .....  
*F. succisae* .....  
*F. bulbicola* .....  
*Fusarium* sp. (NRRL25623) .....  
*Fusarium* sp. (NRRL29123) .....  
*Fusarium* sp. (NRRL29124) .....  
*F. guttiforme* .....  
*F. begoniae* ..... N.....  
*F. fujikuroi* (MP-C) ..... CA. .... T. .... G. .... G. .... A...  
*F. proliferatum* (MP-D) ..... CA. .... T. .... G. .... G. .... A...  
*F. sacchari* (MP-B) ..... G. CA. .... T. .... G. .... G.A. .... A...  
*F. thapsinum* (MP-F) ..... T. T. .... G. .... C. .... A...  
*F. verticillioides* (MP-A) ..... T. .... A...  
*F. nygamai* (MP-G) ..... T. .... A...  
*F. inflexum* --- ..... CT. T. .... T. .... A...



	190	200	210	220	230	240
<b>Host = Teosinte</b>						
<i>F. subglutinans</i> (Fst10)	GAGCTAAACG	CCTCGCTCTA	GGCCAAATTA	CCACTAAGGA	GCTCGGTACC	GTTATGCGCT
<i>F. subglutinans</i> (Fst26)	.....	.....	.....	.....	.....	.....
<i>F. subglutinans</i> (Fst40)	.....	.....	.....	.....	.....	.....
<i>F. subglutinans</i> (Fst51)	.....	.....	.....	.....	.....	.....
<b>MP-E; Host = Maize</b>						
<i>F. subglutinans</i> (MRC714)	.....	.....	.....	.....	.....	.....
<i>F. subglutinans</i> (MRC756)	.....	.....	.....	.....	.....	.....
<i>F. subglutinans</i> (MRC1084)	.....	.....	.....	.....	.....	.....
<i>F. subglutinans</i> (MRC6483)	.....	.....	.....	.....	.....	.....
<i>F. subglutinans</i> (MRC6512)	.....	.....	.....	.....	.....	.....
<b>MP-H; Host = Pine</b>						
<i>F. subglutinans</i> (MRC6213)	.....	.....	.....	.....	.....	.....
<i>F. subglutinans</i> (MRC7488)	.....	.....	.....	.....	.....	.....
<i>F. bactridioides</i>	.....	.....	.....	.....	.....	.....
<i>Fusarium</i> sp. (NRRL25622)	.....	.....	.....	.....	.....	.....
<i>F. anthophilum</i>	.....	.....	.....	.....	.....	.....
<i>F. succisae</i>	.....	.....	.....	.....	.....	.....
<i>F. bulbicola</i>	.....	.....	.....	.....	.....	.....
<i>Fusarium</i> sp. (NRRL25623)	.....	.....T.....	.....	.....	.....	.....
<i>Fusarium</i> sp. (NRRL29123)	.....	.....	.....	.....	.....	.....
<i>Fusarium</i> sp. (NRRL29124)	.....	.....	.....	.....	.....	.....
<i>F. guttiforme</i>	.....	.....	.....	.....A.....	.....	.....
<i>F. begoniae</i>	.....	.....	.....	.....	.....	.....
<i>F. fujikuroi</i> (MP-C)	.....	.....G.....	.....G.....	.....C.....	.....	.....
<i>F. proliferatum</i> (MP-D)	.....	.....G.....	.....G.....	.....C.....	.....	.....
<i>F. sacchari</i> (MP-B)	.....	.....T.....	.....G.....	.....C.....	.....	.....
<i>F. thapsinum</i> (MP-F)	.....	.....	.....G.....	.....C.....	.....	.....
<i>F. verticillioides</i> (MP-A)	.....	.....	.....G.....	.....C.....	.....	.....
<i>F. nygamai</i> (MP-G)	.....	.....	.....G.....	.....C.....	.....	.....
<i>F. inflexum</i>	.....	.....	.....G.....	.....C.....	.....	.....
	250	260	270	280	290	300
<b>Host = Teosinte</b>						
<i>F. subglutinans</i> (Fst10)	CTCTCGGCCA	GAACCCCTCC	GAGTCTGAGC	TTCAGGACAT	GATCAACGAG	GTTGACGCCG
<i>F. subglutinans</i> (Fst26)	.....	.....	.....	.....	.....	.....
<i>F. subglutinans</i> (Fst40)	.....	.....	.....	.....	.....	.....
<i>F. subglutinans</i> (Fst51)	.....	.....	.....	.....	.....	.....
<b>MP-E; Host = Maize</b>						
<i>F. subglutinans</i> (MRC714)	.....	.....	.....	.....	.....	.....
<i>F. subglutinans</i> (MRC756)	.....	.....	.....	.....	.....	.....
<i>F. subglutinans</i> (MRC1084)	.....	.....	.....	.....	.....	.....
<i>F. subglutinans</i> (MRC6483)	.....	.....	.....	.....	.....	.....
<i>F. subglutinans</i> (MRC6512)	.....	.....	.....	.....	.....	.....
<b>MP-H; Host = Pine</b>						
<i>F. subglutinans</i> (MRC6213)	.....	.....T.....	.....	.....	.....	.....
<i>F. subglutinans</i> (MRC7488)	.....	.....T.....	.....	.....	.....	.....
<i>F. bactridioides</i>	.....	.....	.....	.....	.....	.....
<i>Fusarium</i> sp. (NRRL25622)	.....	.....	.....	.....	.....	.....
<i>F. anthophilum</i>	.....	.....	.....	.....	.....	.....
<i>F. succisae</i>	.....	.....	.....	.....	.....	.....
<i>F. bulbicola</i>	.....	.....T.....	.....	.....	.....	.....
<i>Fusarium</i> sp. (NRRL25623)	.....T.....	.....T.....	.....	.....	.....	.....
<i>Fusarium</i> sp. (NRRL29123)	.....	.....	.....T.....	.....	.....	.....
<i>Fusarium</i> sp. (NRRL29124)	.....	.....	.....T.....	.....	.....	.....
<i>F. guttiforme</i>	.....	.....	.....	.....	.....	.....
<i>F. begoniae</i>	.....	.....T.....	.....	.....	.....	.....
<i>F. fujikuroi</i> (MP-C)	.....T.....	.....	.....	.....	.....	.....
<i>F. proliferatum</i> (MP-D)	.....T.....	.....	.....	.....	.....	.....
<i>F. sacchari</i> (MP-B)	.....T.....	.....	.....C.....	.....	.....	.....
<i>F. thapsinum</i> (MP-F)	.....	.....	.....	.....	.....	.....
<i>F. verticillioides</i> (MP-A)	.....	.....	.....	.....	.....	.....T.....
<i>F. nygamai</i> (MP-G)	.....	.....	.....	.....	.....	.....
<i>F. inflexum</i>	.....	.....	.....	.....	.....	.....



	310	320	330	340	350	360
<b>Host = Teosinte</b>						
<i>F. subglutinans</i> (Fst10)	ACAATAACGG	CACCATCGAC	TTTCCTGGTG	CGTAGTATTC	CAAGGCGATC	AGAGGA---C
<i>F. subglutinans</i> (Fst26)	.....	.....	.....	.....	.....	.....
<i>F. subglutinans</i> (Fst40)	.....T..	.....	.....	.....	.....	.....
<i>F. subglutinans</i> (Fst51)	.....	.....	.....	.....	.....	.....
<b>MP-E; Host = Maize</b>						
<i>F. subglutinans</i> (MRC714)	.....T..	.....	.....	.....	.....	.....
<i>F. subglutinans</i> (MRC756)	.....	.....	.....	.....	.....	.....
<i>F. subglutinans</i> (MRC1084)	.....	.....	.....	.....	.....	.....
<i>F. subglutinans</i> (MRC6483)	.....T..	.....	.....	.....	.....	.....
<i>F. subglutinans</i> (MRC6512)	.....T..	.....	.....	.....	.....	.....
<b>MP-H; Host = Pine</b>						
<i>F. subglutinans</i> (MRC6213)	.....	.....	.....	.....	.....	----T
<i>F. subglutinans</i> (MRC7488)	.....	.....	.....	.....	.....	----T
<i>F. bactridioides</i>	.....	.....	.....	.....	.....	A..GGA.
<i>Fusarium</i> sp. (NRRL25622)	.....	.....	.....	.....	.....	.....
<i>F. anthophilum</i>	.....	.....	.....	.....	.....	.....
<i>F. succisae</i>	.....	.....	.....	.....	.....	.....
<i>F. bulbicola</i>	.....	.....	.....	.....	.....	.....
<i>Fusarium</i> sp. (NRRL25623)	...C....	.....	.....	.....	.....	.....
<i>Fusarium</i> sp. (NRRL29123)	.....	.....	.....	.....	.....	----T
<i>Fusarium</i> sp. (NRRL29124)	.....	.....	.....	.....	.....	----T
<i>F. guttiforme</i>	...C....	T.....	.....	.....	.....	.....
<i>F. begoniae</i>	...C....	.....	.....	.....	.....	.....
<i>F. fujikuroi</i> (MP-C)	...C....	.....	.....	.....	AAT...T	.....
<i>F. proliferatum</i> (MP-D)	...C....	.....	.....	.....	AAT...T	.....
<i>F. sacchari</i> (MP-B)	...C....	.....	.....	.....T	...AT...T	T.....
<i>F. thapsinum</i> (MP-F)	...C....	.....	.....T	.....	...A...T	G----
<i>F. verticillioides</i> (MP-A)	...C....	.....T	.....	...C...	...A...T	T.....
<i>F. nygamai</i> (MP-G)	...C....	.....T	.....	.....	.G..A...	.....
<i>F. inflexum</i>	...C....	.....	.....	...A....	...A...T	.....

	370	380	390	400	405
<b>Host = Teosinte</b>					
<i>F. subglutinans</i> (Fst10)	GGTC-AGTAC	TAACCACTGG	GTAAAGAGTT	CCTCACCATG	ATGGC
<i>F. subglutinans</i> (Fst26)	.....	.....	.....	.....	.....
<i>F. subglutinans</i> (Fst40)	.....	.....	.....	.....	.....
<i>F. subglutinans</i> (Fst51)	.....	.....	.....	.....	.....
<b>MP-E; Host = Maize</b>					
<i>F. subglutinans</i> (MRC714)	.....	.....	.....	.....	.....
<i>F. subglutinans</i> (MRC756)	.....	.....	.....	.....	.....
<i>F. subglutinans</i> (MRC1084)	.....	.....	.....	.....	.....
<i>F. subglutinans</i> (MRC6483)	.....	.....	.....	.....	.....
<i>F. subglutinans</i> (MRC6512)	.....	.....	.....	.....	.....
<b>MP-H; Host = Pine</b>					
<i>F. subglutinans</i> (MRC6213)	.....	.....	.....	.....	.....
<i>F. subglutinans</i> (MRC7488)	.....	.....	.....	.....	.....
<i>F. bactridioides</i>	.....	.....	.....	.....	.....
<i>Fusarium</i> sp. (NRRL25622)	.....	.....	.....	.....	.....
<i>F. anthophilum</i>	.....	.....	.....	.....	.....
<i>F. succisae</i>	.....	.....	.....	.....	.....
<i>F. bulbicola</i>	.....	.....	.....	.....	.....
<i>Fusarium</i> sp. (NRRL25623)	.....	.....	.....	.....	.....
<i>Fusarium</i> sp. (NRRL29123)	.....	.....	.....	.....	.....
<i>Fusarium</i> sp. (NRRL29124)	.....	.....	.....	.....	.....
<i>F. guttiforme</i>	.....	.....	.....	.....	.....
<i>F. begoniae</i>	.....	.....	.....	.....	.....
<i>F. fujikuroi</i> (MP-C)	.....	.....	.....	.....	.....
<i>F. proliferatum</i> (MP-D)	.....	.....	.....	.....	.....
<i>F. sacchari</i> (MP-B)	T..T-	.....	.....	.....	.....
<i>F. thapsinum</i> (MP-F)	...G...	.....	N.A.	.....	.....
<i>F. verticillioides</i> (MP-A)	...G...	.....	T.A.	.....	T.....
<i>F. nygamai</i> (MP-G)	...G...	.....	T...	.....	.....
<i>F. inflexum</i>	.....	.....	T...	.....	.....



**Partial  $\beta$ -tubulin (exons 2 and 3)**

	10	20	30	40	50	60
<b>Host = Teosinte</b>						
<i>F. subglutinans</i> (Fst10)	CAAATCGGTG	CTGCTTTCTG	GCAAACCATC	TCTGGCGAGC	ACGGCCTCGA	CAGCAATGGT
<i>F. subglutinans</i> (Fst26)	.....	.....	.....	.....	.....	.....
<i>F. subglutinans</i> (Fst40)	.....	.....	.....	.....	.....	.....
<i>F. subglutinans</i> (Fst51)	.....	.....	.....	.....	.....	.....
<b>MP-E; Host = Maize</b>						
<i>F. subglutinans</i> (MRC714)	.....	.....	.....	.....	.....	.....
<i>F. subglutinans</i> (MRC756)	.....	.....	.....	.....	.....	.....
<i>F. subglutinans</i> (MRC1084)	.....	.....	.....	.....	.....	.....
<i>F. subglutinans</i> (MRC6483)	.....	.....	.....	.....	.....	.....
<i>F. subglutinans</i> (MRC6512)	.....	.....	.....	.....	.....	.....
<b>MP-H; Host = Pine</b>						
<i>F. subglutinans</i> (MRC6213)	.....	.....	.....	.....	.....	.....
<i>F. subglutinans</i> (MRC7488)	.....	.....	.....	.....	.....	.....
<i>F. bactridioides</i>	.....T.....	.....	.....	.....	.....	.....
<i>Fusarium</i> sp. (NRRL25622)	.....T.....	.....	.....	.....	.....	.....
<i>F. anthophilum</i>	.....T.....	.....	.....	.....	.....	.....
<i>F. succisae</i>	.....T.....	.....	.....	.....	.....	.....
<i>F. bulbicola</i>	.....T.....	.....	.....	.....	.....	.....
<i>Fusarium</i> sp. (NRRL25623)	.....T.....	.....	.....	.....	.....	.....
<i>Fusarium</i> sp. (NRRL29123)	.....T.....	.....	.....	.....	.....	.....
<i>Fusarium</i> sp. (NRRL29124)	.....T.....	.....	.....	.....	.....	.....
<i>F. guttiforme</i>	.....T.....	.....	.....	.....	.....	.....
<i>F. begoniae</i>	.....T.....	.....	.....T.....	.....	.....	.....
<i>F. fujikuroi</i> (MP-C)	.....T.....	.....	.....	.....	.....	.....
<i>F. proliferatum</i> (MP-D)	.....T.....	.....	.....	.....	.....	.....
<i>F. sacchari</i> (MP-B)	.....T.....	.....	.....	.....	.....	.....
<i>F. thapsinum</i> (MP-F)	.....T.....	.....	.....	.....	.....	.....
<i>F. verticillioides</i> (MP-A)	.....T.....	.....	.....	.....	.....	.....
<i>F. nygamai</i> (MP-G)	.....T.....	.....	.....	.....	.....	.....
<i>F. inflexum</i>	.....	.....	.....	.....	.....	.....
	70	80	90	100	110	120
<b>Host = Teosinte</b>						
<i>F. subglutinans</i> (Fst10)	GTCTACAACG	GTACCTCCGA	GCTCCAGCTC	GAGCGTATGA	GTGTCTACTT	CAACGAGGTA
<i>F. subglutinans</i> (Fst26)	.....	.....	.....	.....	.....	.....
<i>F. subglutinans</i> (Fst40)	.....	.....	.....	.....	.....	.....
<i>F. subglutinans</i> (Fst51)	.....	.....	.....	.....	.....	.....
<b>MP-E; Host = Maize</b>						
<i>F. subglutinans</i> (MRC714)	.....	.....	.....	.....	.....	.....
<i>F. subglutinans</i> (MRC756)	.....	.....	.....	.....	.....	.....
<i>F. subglutinans</i> (MRC1084)	.....	.....	.....	.....	.....	.....
<i>F. subglutinans</i> (MRC6483)	.....	.....	.....	.....	.....	.....
<i>F. subglutinans</i> (MRC6512)	.....	.....	.....	.....	.....	.....
<b>MP-H; Host = Pine</b>						
<i>F. subglutinans</i> (MRC6213)	.....	.....	.....	.....	.....	.....
<i>F. subglutinans</i> (MRC7488)	.....	.....	.....	.....	.....	.....
<i>F. bactridioides</i>	.....	.....	.....	.....	.....	.....
<i>Fusarium</i> sp. (NRRL25622)	.....	.....	.....	.....	.....	.....
<i>F. anthophilum</i>	.....	.....	.....	.....	.....	.....
<i>F. succisae</i>	.....	.....	.....	.....	.....	.....
<i>F. bulbicola</i>	.....	.....C.....	.....	.....	.....	.....
<i>Fusarium</i> sp. (NRRL25623)	.....	.....	.....	.....	.....	.....
<i>Fusarium</i> sp. (NRRL29123)	.....	.....	.....	.....	.....	.....
<i>Fusarium</i> sp. (NRRL29124)	.....	.....	.....	.....	.....	.....
<i>F. guttiforme</i>	.....	.....	.....	.....	.....	.....
<i>F. begoniae</i>	.....	.....	.....	.....	.....	.....
<i>F. fujikuroi</i> (MP-C)	.....	.....	.....	.....C.....	.....	.....
<i>F. proliferatum</i> (MP-D)	.....	.....	.....	.....C.....	.....	.....
<i>F. sacchari</i> (MP-B)	.....	.....	.....	.....C.....	.....	.....
<i>F. thapsinum</i> (MP-F)	.....	.....	.....T.....	.....C.....	.....T.....	.....
<i>F. verticillioides</i> (MP-A)	.....T.....	.....	.....T.....	.....C.....	.....T.....	.....
<i>F. nygamai</i> (MP-G)	.....	.....	.....T.....	.....C.....	.....T.....	.....
<i>F. inflexum</i>	.....	.....	.....	.....C.....	.....	.....



130 140 150 160 170 180

**Host = Teosinte**

*F. subglutinans* (Fst10) TGCTTTAACA GTC AATGCCA AGAATTCCCA AGCTCACACA ACTAGGCCTC TGGCAACAAG  
*F. subglutinans* (Fst26) .....  
*F. subglutinans* (Fst40) .....  
*F. subglutinans* (Fst51) .....

**MP-E; Host = Maize**

*F. subglutinans* (MRC714) .....  
*F. subglutinans* (MRC756) .....G.....  
*F. subglutinans* (MRC1084) .....  
*F. subglutinans* (MRC6483) .....  
*F. subglutinans* (MRC6512) .....

**MP-H; Host = Pine**

*F. subglutinans* (MRC6213) .....G.....  
*F. subglutinans* (MRC7488) .....G.....  
*F. bactridioides* .....G.....  
*Fusarium* sp. (NRRL25622) .....  
*F. anthophilum* .....  
*F. succisae* .....  
*F. bulbicola* .....  
*Fusarium* sp. (NRRL25623) ...A.....  
*Fusarium* sp. (NRRL29123) .....T.....G.....  
*Fusarium* sp. (NRRL29124) .....T.....G.....  
*F. guttiforme* ...A.....A.....  
*F. begoniae* ...A.....T.....  
*F. fujikuroi* (MP-C) ...C.....T...C.....  
*F. proliferatum* (MP-D) ...C.....T...C.A.....  
*F. sacchari* (MP-B) ...A.....T.....  
*F. thapsinum* (MP-F) ...TA...G...T...T...G.....T.....  
*F. verticillioides* (MP-A) ...A...G...T...G...A...C.....T.....  
*F. nygamai* (MP-G) ...A...G...T...G.....T.....T.....  
*F. inflexum* ...A.....T.....

190 200 210 220 230 240

**Host = Teosinte**

*F. subglutinans* (Fst10) TATGTTCCCC GAGCCGTCCT CGTCGATCTT GAGCCTGGTA CCATGGACGC CGTCCGAGCT  
*F. subglutinans* (Fst26) .....T.....  
*F. subglutinans* (Fst40) .....  
*F. subglutinans* (Fst51) .....T.....

**MP-E; Host = Maize**

*F. subglutinans* (MRC714) .....  
*F. subglutinans* (MRC756) .....T.....  
*F. subglutinans* (MRC1084) .....T.....  
*F. subglutinans* (MRC6483) .....  
*F. subglutinans* (MRC6512) .....

**MP-H; Host = Pine**

*F. subglutinans* (MRC6213) .....  
*F. subglutinans* (MRC7488) .....  
*F. bactridioides* .....  
*Fusarium* sp. (NRRL25622) .....T.....  
*F. anthophilum* .....  
*F. succisae* .....  
*F. bulbicola* .....  
*Fusarium* sp. (NRRL25623) .....C.....  
*Fusarium* sp. (NRRL29123) .....  
*Fusarium* sp. (NRRL29124) .....  
*F. guttiforme* .....T.....  
*F. begoniae* .....  
*F. fujikuroi* (MP-C) .....T...T...  
*F. proliferatum* (MP-D) .....T...T...  
*F. sacchari* (MP-B) .....T...  
*F. thapsinum* (MP-F) .....C.....T...C  
*F. verticillioides* (MP-A) .....C...C.....T...  
*F. nygamai* (MP-G) .....C.....T...  
*F. inflexum* .....T...





	250	260	270	280	290	296
<b>Host = Teosinte</b>						
<i>F. subglutinans</i> (Fst10)	GGTCCCTTCG	GTCAGCTCTT	CCGTCCCGAC	AACTTCGTTT	TCGGTCAGTC	CGGTGC
<i>F. subglutinans</i> (Fst26)	.....	.....	.....	.....	.....C.....	.....
<i>F. subglutinans</i> (Fst40)	.....	.....	.....	.....	.....	.....
<i>F. subglutinans</i> (Fst51)	.....	.....	.....	.....	.....	.....
<b>MP-E; Host = Maize</b>						
<i>F. subglutinans</i> (MRC714)	.....	.....	.....	.....	.....	.....
<i>F. subglutinans</i> (MRC756)	.....	.....	.....	.....	.....	.....
<i>F. subglutinans</i> (MRC1084)	.....	.....	.....	.....	.....	.....
<i>F. subglutinans</i> (MRC6483)	.....	.....	.....	.....	.....	.....
<i>F. subglutinans</i> (MRC6512)	.....	.....	.....	.....	.....	.....
<b>MP-H; Host = Pine</b>						
<i>F. subglutinans</i> (MRC6213)	.....	.....	.....	.....	.....	.....
<i>F. subglutinans</i> (MRC7488)	.....	.....	.....	.....	.....	.....
<i>F. bactridioides</i>	.....	.....	.....	.....	.....	.....
<i>Fusarium</i> sp. (NRRL25622)	.....	.....	.....	.....	.....	.....
<i>F. anthophilum</i>	.....	.....	.....	.....	.....	.....
<i>F. succisae</i>	.....	.....	.....	.....	.....	.....
<i>F. bulbicola</i>	.....	.....	.....	.....	.....	.....
<i>Fusarium</i> sp. (NRRL25623)	.....	.....	.....	.....	.....	.....
<i>Fusarium</i> sp. (NRRL29123)	.....	.....	.....	.....T.....	.....	.....
<i>Fusarium</i> sp. (NRRL29124)	.....	.....	.....	.....T.....	.....	.....
<i>F. guttiforme</i>	.....	.....	.....	.....	.....	.....
<i>F. begoniae</i>	.....	.....	.....	.....	.....	.....
<i>F. fujikuroi</i> (MP-C)	.....	.....	.....	.....	.....	.....
<i>F. proliferatum</i> (MP-D)	.....	.....	.....	.....	.....	.....
<i>F. sacchari</i> (MP-B)	.....	.....	.....	.....	.....	.....
<i>F. thapsinum</i> (MP-F)	.....	.....	.....	.....	.....C.....	.....
<i>F. verticillioides</i> (MP-A)	.....	.....	.....	.....	.....	.....
<i>F. nygamai</i> (MP-G)	.....	.....	.....	.....	.....	.....
<i>F. inflexum</i>	.....	.....	.....	.....nn	nnnnnnnnnn	nnnnnn



**MtSSU**

	10	20	30	40	50	60
<b>Host = Teosinte</b>						
<i>F. subglutinans</i> (Fst10)	ACGGCTGAAC	TGGCAACTTG	GAGAAGTGGC	AAGTCTTCCA	GTATGGGGAG	CAAAACAGCT
<i>F. subglutinans</i> (Fst26)	.....	.....	.....	.....	.....	.....
<i>F. subglutinans</i> (Fst40)	.....	.....	.....	.....	.....	.....
<i>F. subglutinans</i> (Fst51)	.....	.....	.....	.....	.....	.....
<b>MP-E; Host = Maize</b>						
<i>F. subglutinans</i> (MRC714)	.....	.....	.....	.....	.....	.....
<i>F. subglutinans</i> (MRC756)	.....	.....	.....	.....	.....	.....
<i>F. subglutinans</i> (MRC1084)	.....	.....	.....	.....	.....	.....
<i>F. subglutinans</i> (MRC6483)	.....	.....	.....	.....	.....	.....
<i>F. subglutinans</i> (MRC6512)	.....	.....	.....	.....	.....	.....
<b>MP-H; Host = Pine</b>						
<i>F. subglutinans</i> (MRC6213)	.....	.....	.....	.....	.....	.....
<i>F. subglutinans</i> (MRC7488)	.....	.....	.....	.....	.....	.....
<i>F. bactridioides</i>	.....	.....	.....	.....	.....	.....
<i>Fusarium</i> sp. (NRRL25622)	.....	.....	.....	.....	.....	.....
<i>F. anthophilum</i>	.....	.....	.....	.....	.....	.....
<i>F. succisae</i>	.....	.....	.....	.....	.....	.....
<i>F. bulbicola</i>	.....	.....	.....	.....	.....	.....
<i>Fusarium</i> sp. (NRRL25623)	.....	.....	.....	.....	.....	.....
<i>Fusarium</i> sp. (NRRL29123)	.....	.....	.....	.....	.....	.....
<i>Fusarium</i> sp. (NRRL29124)	.....	.....	.....	.....	.....	.....
<i>F. guttiforme</i>	.....	.....	.....	.....	.....	.....
<i>F. begoniae</i>	.....	.....	.....	.....	.....	.....
<i>F. fujikuroi</i> (MP-C)	.....	.....	.....	.....	.....	.....
<i>F. proliferatum</i> (MP-D)	.....	.....	.....	.....	.....	.....
<i>F. sacchari</i> (MP-B)	.....	.....	.....	.....	.....	.....
<i>F. thapsinum</i> (MP-F)	.....	.....	.....	.....	.....	.....
<i>F. verticillioides</i> (MP-A)	.....	.....	.....	.....	.....	.....
<i>F. nygamai</i> (MP-G)	.....	.....	.....	.....	.....	.....
<i>F. inflexum</i>	.....	.....	.....	.....	.....	.....
	70	80	90	100	110	120
<b>Host = Teosinte</b>						
<i>F. subglutinans</i> (Fst10)	ATGGGTCAAG	TCCGATATCT	TTAGGAGGCG	CGAAGCTCCT	CTTATTGTGA	GGGCGAGTTT
<i>F. subglutinans</i> (Fst26)	.....	.....	.....	.....	.....	.....
<i>F. subglutinans</i> (Fst40)	.....	.....	.....	.....	.....	.....
<i>F. subglutinans</i> (Fst51)	.....	.....	.....	.....	.....	.....
<b>MP-E; Host = Maize</b>						
<i>F. subglutinans</i> (MRC714)	.....	.....	.....	.....	.....	.....
<i>F. subglutinans</i> (MRC756)	.....	.....	.....	.....	.....	.....
<i>F. subglutinans</i> (MRC1084)	.....	.....	.....	.....	.....	.....
<i>F. subglutinans</i> (MRC6483)	.....	.....	.....	.....	.....	.....
<i>F. subglutinans</i> (MRC6512)	.....	.....	.....	.....	.....	.....
<b>MP-H; Host = Pine</b>						
<i>F. subglutinans</i> (MRC6213)	.....	.....	.....	.....	.....	.....
<i>F. subglutinans</i> (MRC7488)	.....	.....	.....	.....	.....	.....
<i>F. bactridioides</i>	.....	.....	.....	.....	.....	.....
<i>Fusarium</i> sp. (NRRL25622)	.....	.....	.....	.....	.....	.....
<i>F. anthophilum</i>	.....	.....	.....	.....	.....	.....
<i>F. succisae</i>	.....	.....	.....	.....	.....	.....
<i>F. bulbicola</i>	.....	G.	.....	.....	.....	.....
<i>Fusarium</i> sp. (NRRL25623)	.....	.....	.....	.....	.....	.....
<i>Fusarium</i> sp. (NRRL29123)	.....	.....	.....	.....	.....	.....
<i>Fusarium</i> sp. (NRRL29124)	.....	.....	.....	.....	.....	.....
<i>F. guttiforme</i>	.....	.....	.....	.....	.....	.....
<i>F. begoniae</i>	.....	.....	.....	.....	.....	.....
<i>F. fujikuroi</i> (MP-C)	.....	T.	G.	.....	.....	A
<i>F. proliferatum</i> (MP-D)	.....	T.	G.	.....	.....	A
<i>F. sacchari</i> (MP-B)	.....	T.	G.	G.	.....	A
<i>F. thapsinum</i> (MP-F)	.....	.....	.....	.....	.....	.....
<i>F. verticillioides</i> (MP-A)	.....	.....	.....	.....	.....	.....
<i>F. nygamai</i> (MP-G)	.....	.....	.....	.....	.....	.....
<i>F. inflexum</i>	.....	.....	.....	.....	.....	A



	130	140	150	160	170	180
<b>Host = Teosinte</b>						
<i>F. subglutinans</i> (Fst10)	TATAACACCA	TAGGACTGGC	CGTCCCATAT	GAAAAGATTA	TATTAGAATT	GAATGAAGCT
<i>F. subglutinans</i> (Fst26)	.....	.....	.....	.....	.....	.....
<i>F. subglutinans</i> (Fst40)	.....	.....	.....	.....	.....	.....
<i>F. subglutinans</i> (Fst51)	.....	.....	.....	.....	.....	.....
<b>MP-E; Host = Maize</b>						
<i>F. subglutinans</i> (MRC714)	.....	.....	.....	.....	.....	.....
<i>F. subglutinans</i> (MRC756)	.....	.....	.....	.....	.....	.....
<i>F. subglutinans</i> (MRC1084)	.....	.....	.....	.....	.....	.....
<i>F. subglutinans</i> (MRC6483)	.....	.....	.....	.....	.....	.....
<i>F. subglutinans</i> (MRC6512)	.....	.....	.....	.....	.....	.....
<b>MP-H; Host = Pine</b>						
<i>F. subglutinans</i> (MRC6213)	.....	.....	.....	.....	.....	.....
<i>F. subglutinans</i> (MRC7488)	.....	.....	.....	.....	.....	.....
<i>F. bactridioides</i>	.....	.....	..C.	.....	.....	.....
<i>Fusarium</i> sp. (NRRL25622)	.....	.....	..n	..n	.....	.....
<i>F. anthophilum</i>	.....	.....	.....	.....	.....	.....
<i>F. succisae</i>	.....	.....	..C.	.....	.....	.....
<i>F. bulbicola</i>	.....	.....	.....	.....	.....	.....
<i>Fusarium</i> sp. (NRRL25623)	.....	.....	.....	.....	.....	.....
<i>Fusarium</i> sp. (NRRL29123)	.....	.....	.....	.....	.....	.....
<i>Fusarium</i> sp. (NRRL29124)	.....	.....	.....	.....	.....	.....
<i>F. guttiforme</i>	.....	.....	..n	.....	.....	.....
<i>F. begoniae</i>	.....	.....	..C.	.....	.....	..C.
<i>F. fujikuroi</i> (MP-C)	.....	.....	..C.	.....	.....	.....
<i>F. proliferatum</i> (MP-D)	.....	.....	..C.	.....	.....	.....
<i>F. sacchari</i> (MP-B)	.....	.....	..C.	.....	.....	.....
<i>F. thapsinum</i> (MP-F)	.....	.....	..C.	.....	.....	.....
<i>F. verticillioides</i> (MP-A)	.....	.....	..C.	.....	.....	.....
<i>F. nygamai</i> (MP-G)	.....	.....	..C.	.....	.....	.....
<i>F. inflexum</i>	.....	.....	..C.	.....	.....	.....

	190	200	210	220	230	240
<b>Host = Teosinte</b>						
<i>F. subglutinans</i> (Fst10)	TTGTTTATAT	ATTGATAATG	ACAGTATATA	TATCGTGTCT	TGACTAATTG	CGTGCCAGCA
<i>F. subglutinans</i> (Fst26)	.....	.....	.....	.....	.....	.....
<i>F. subglutinans</i> (Fst40)	.....	.....	.....	.....	.....	.....
<i>F. subglutinans</i> (Fst51)	.....	.....	.....	.....	.....	.....
<b>MP-E; Host = Maize</b>						
<i>F. subglutinans</i> (MRC714)	.....	.....	.....	.....	.....	.....
<i>F. subglutinans</i> (MRC756)	.....	.....	.....	.....	.....	.....
<i>F. subglutinans</i> (MRC1084)	.....	.....	.....	.....	.....	.....
<i>F. subglutinans</i> (MRC6483)	.....	.....	.....	.....	.....	.....
<i>F. subglutinans</i> (MRC6512)	.....	.....	.....	.....	.....	.....
<b>MP-H; Host = Pine</b>						
<i>F. subglutinans</i> (MRC6213)	.....	.....	.....	.....	.....	.....
<i>F. subglutinans</i> (MRC7488)	.....	.....	.....	.....	.....	.....
<i>F. bactridioides</i>	.....	.....	.....	.....	.....	.....
<i>Fusarium</i> sp. (NRRL25622)	.....	.....	.....	.....	.....	.....
<i>F. anthophilum</i>	.....	.....	.....	.....	.....	.....
<i>F. succisae</i>	.....	.....	.....	.....	.....	.....
<i>F. bulbicola</i>	.....	.....	.....	.....	.....	.....
<i>Fusarium</i> sp. (NRRL25623)	.....	.....	.....	.....	.....	.....
<i>Fusarium</i> sp. (NRRL29123)	.....	.....	.....	.....	.....	.....
<i>Fusarium</i> sp. (NRRL29124)	.....	.....	.....	.....	.....	.....
<i>F. guttiforme</i>	.....	.....	.....	.....	.....	.....
<i>F. begoniae</i>	.....	.....	.....	.....	.....	.....
<i>F. fujikuroi</i> (MP-C)	.....	.....	.....	.....	.....	.....
<i>F. proliferatum</i> (MP-D)	.....	.....	.....	.....	.....	.....
<i>F. sacchari</i> (MP-B)	.....	.....	.....	.....	.....	.....
<i>F. thapsinum</i> (MP-F)	.....	.....	.....	.....	.....	.....
<i>F. verticillioides</i> (MP-A)	.....	.....	.....	.....	.....	.....
<i>F. nygamai</i> (MP-G)	.....	.....	.....	.....	.....	.....
<i>F. inflexum</i>	.....	.....	.....	.....	.....	.....



	250	260	270	280	290	300
<b>Host = Teosinte</b>						
<i>F. subglutinans</i> (Fst10)	GTCGCGGTAA	TACGTAAGAG	ACTAGTGTTA	TTCATCTTAA	TTAGGTTTAA	AGGGTACCCA
<i>F. subglutinans</i> (Fst26)	.....	.....	.....	.....	.....	.....
<i>F. subglutinans</i> (Fst40)	.....	.....	.....	.....	.....	.....
<i>F. subglutinans</i> (Fst51)	.....	.....	.....	.....	.....	.....
<b>MP-E; Host = Maize</b>						
<i>F. subglutinans</i> (MRC714)	.....	.....	.....	.....	.....	.....
<i>F. subglutinans</i> (MRC756)	.....	.....	.....	.....	.....	.....
<i>F. subglutinans</i> (MRC1084)	.....	.....	.....	.....	.....	.....
<i>F. subglutinans</i> (MRC6483)	.....	.....	.....	.....	.....	n.....
<i>F. subglutinans</i> (MRC6512)	.....	.....	.....	.....	.....	.....
<b>MP-H; Host = Pine</b>						
<i>F. subglutinans</i> (MRC6213)	.....	.....	.....	.....	.....	.....
<i>F. subglutinans</i> (MRC7488)	.....	.....	.....	.....	.....	.....
<i>F. bactridioides</i>	.....	.....	.....	.....	.....	.....
<i>Fusarium</i> sp. (NRRL25622)	.....	.....	.....	.....	.....	.....
<i>F. anthophilum</i>	.....	.....	.....	.....	.....	.....
<i>F. succisae</i>	.....	.....	.....	.....	.....	.....
<i>F. bulbicola</i>	.....	.....	.....	.....	.....	.....
<i>Fusarium</i> sp. (NRRL25623)	.....	.....	.....	.....	.....	.....
<i>Fusarium</i> sp. (NRRL29123)	.....	.....	.....	.....	.....	.....
<i>Fusarium</i> sp. (NRRL29124)	.....	.....	.....	.....	.....	.....
<i>F. guttiforme</i>	.....	.....	.....	.....	.....	.....
<i>F. begoniae</i>	.....	.....	.....	.....	.....	.....
<i>F. fujikuroi</i> (MP-C)	.....	.....	.....	.....	.....	.....
<i>F. proliferatum</i> (MP-D)	.....	.....	.....	.....	.....	.....
<i>F. sacchari</i> (MP-B)	.....	.....	.....	.....	.....	.....
<i>F. thapsinum</i> (MP-F)	.....	.....	.....	.....	.....	.....
<i>F. verticillioides</i> (MP-A)	.....	.....	.....	.....	.....	.....
<i>F. nygamai</i> (MP-G)	.....	.....	.....	.....	.....	.....
<i>F. inflexum</i>	.....	.....	.....	.....	.....	.....
	310	320	330	340	350	360
<b>Host = Teosinte</b>						
<i>F. subglutinans</i> (Fst10)	GACGGTCAAT	ATAGCTTATA	AAATGTTAGT	ACTTGACTAG	AGTTTTATGT	AAGAGGGCAG
<i>F. subglutinans</i> (Fst26)	.....	.....	.....	.....	.....	.....
<i>F. subglutinans</i> (Fst40)	.....	.....	.....	.....	.....	.....
<i>F. subglutinans</i> (Fst51)	.....	.....	.....	.....	.....	.....
<b>MP-E; Host = Maize</b>						
<i>F. subglutinans</i> (MRC714)	.....	.....	.....	.....	.....	.....
<i>F. subglutinans</i> (MRC756)	.....	.....	.....	.....	.....	.....
<i>F. subglutinans</i> (MRC1084)	.....	.....	.....	.....	.....	.....
<i>F. subglutinans</i> (MRC6483)N	.....	.....	.....	.....	.....	.....
<i>F. subglutinans</i> (MRC6512)	.....	.....	.....	.....	.....	.....
<b>MP-H; Host = Pine</b>						
<i>F. subglutinans</i> (MRC6213)	.....	.....	.....	.....	.....	.....
<i>F. subglutinans</i> (MRC7488)	.....	.....	.....	.....	.....	.....
<i>F. bactridioides</i>	.....	.....	.....	.....	.....	.....
<i>Fusarium</i> sp. (NRRL25622)	.....	.....	.....	.....	.....	.....
<i>F. anthophilum</i>	.....	.....	.....	.....	.....	.....
<i>F. succisae</i>	.....	.....	.....	.....	.....	.....
<i>F. bulbicola</i>	.....	.....	.....	.....	.....	.....
<i>Fusarium</i> sp. (NRRL25623)	.....	.....	.....	.....	.....	.....
<i>Fusarium</i> sp. (NRRL29123)	.....	.....	.....	.....	.....	.....
<i>Fusarium</i> sp. (NRRL29124)	.....	.....	.....	.....	.....	.....
<i>F. guttiforme</i>	.....	.....	.....	.....	.....	.....
<i>F. begoniae</i>	.....	.....	.....	.....	.....	.....
<i>F. fujikuroi</i> (MP-C)	.....	.....	.....	.....	.....	.....
<i>F. proliferatum</i> (MP-D)	.....	.....	.....	.....	.....	.....
<i>F. sacchari</i> (MP-B)	.....	.....	.....	.....	.....	.....
<i>F. thapsinum</i> (MP-F)	.....	.....	.....	.....	.....	.....
<i>F. verticillioides</i> (MP-A)	.....	.....	.....	.....	.....	.....
<i>F. nygamai</i> (MP-G)	.....	.....	.....	.....	.....	.....
<i>F. inflexum</i>	.....	.....	.....	.....	.....	.....



	370	380	390	400	410	420
<b>Host = Teosinte</b>						
<i>F. subglutinans</i> (Fst10)	TACTTGAGGA	GGAGAGATGA	AATTTTCGTGA	TACCAAAGGG	ACTCGGTAAA	GGCGAAGGCA
<i>F. subglutinans</i> (Fst26)	.....	.....	.....	.....	.....	.....
<i>F. subglutinans</i> (Fst40)	.....	.....	.....	.....	.....	.....
<i>F. subglutinans</i> (Fst51)	.....	.....	.....	.....	.....	.....
<b>MP-E; Host = Maize</b>						
<i>F. subglutinans</i> (MRC714)	.....	.....	.....	.....	.....	.....
<i>F. subglutinans</i> (MRC756)	.....	.....	.....	.....	.....	.....
<i>F. subglutinans</i> (MRC1084)	.....	.....	.....	.....	.....	.....
<i>F. subglutinans</i> (MRC6483)	.....	.....	.....	.....	.....	.....
<i>F. subglutinans</i> (MRC6512)	.....	.....	.....	.....	.....	.....
<b>MP-H; Host = Pine</b>						
<i>F. subglutinans</i> (MRC6213)	.....	.....	.....	.....	.....	.....
<i>F. subglutinans</i> (MRC7488)	.....	.....	.....	.....	.....	.....
<i>F. bactridioides</i>	.....	.....	.....	.....	T	.....
<i>Fusarium</i> sp. (NRRL25622)	.....	.....	.....	.....	.....	.....
<i>F. anthophilum</i>	.....	.....	.....	.....	T	.....
<i>F. succisae</i>	.....	.....	.....	.....	T	.....
<i>F. bulbicola</i>	.....	.....	.....	.....	T	.....
<i>Fusarium</i> sp. (NRRL25623)	.....	.....	.....	.....	.....	.....
<i>Fusarium</i> sp. (NRRL29123)	.....	.....	.....	.....	.....	.....
<i>Fusarium</i> sp. (NRRL29124)	.....	.....	.....	.....	.....	.....
<i>F. guttiforme</i>	.....	.....	.....	.....	.....	.....
<i>F. begoniae</i>	.....	.....	.....	.....	.....	.....
<i>F. fujikuroi</i> (MP-C)	.....	.....	.....	.....	T	.....
<i>F. proliferatum</i> (MP-D)	.....	.....	.....	.....	T	.....
<i>F. sacchari</i> (MP-B)	.....	.....	.....	.....	T	.....
<i>F. thapsinum</i> (MP-F)	.....	.....	.....	.....	T	.....
<i>F. verticillioides</i> (MP-A)	.....	.....	.....	.....	T	.....
<i>F. nygamai</i> (MP-G)	.....	.....	.....	.....	T	.....
<i>F. inflexum</i>	.....	.....	.....	.....	T	.....
	430	440	450	460	470	480
<b>Host = Teosinte</b>						
<i>F. subglutinans</i> (Fst10)	GCCCTCTAGG	TAAAAACTGA	CGTTGAAGGA	CGAAGGCACA	GAGAACAAAC	AGGATTAGAT
<i>F. subglutinans</i> (Fst26)	.....	.....	.....	.....	.....	.....
<i>F. subglutinans</i> (Fst40)	.....	.....	.....	.....	.....	.....
<i>F. subglutinans</i> (Fst51)	.....	.....	.....	.....	.....	.....
<b>MP-E; Host = Maize</b>						
<i>F. subglutinans</i> (MRC714)	.....	.....	.....	.....	.....	.....
<i>F. subglutinans</i> (MRC756)	.....	.....	.....	.....	.....	.....
<i>F. subglutinans</i> (MRC1084)	.....	.....	.....	.....	.....	.....
<i>F. subglutinans</i> (MRC6483)	.....	.....	.....	.....	.....	.....
<i>F. subglutinans</i> (MRC6512)	.....	.....	.....	.....	.....	.....
<b>MP-H; Host = Pine</b>						
<i>F. subglutinans</i> (MRC6213)	.....	.....	.....	.....	.....	.....
<i>F. subglutinans</i> (MRC7488)	.....	.....	.....	.....	.....	.....
<i>F. bactridioides</i>	.....	.....	.....	.....	.....	.....
<i>Fusarium</i> sp. (NRRL25622)	.....	.....	.....	.....	.....	.....
<i>F. anthophilum</i>	.....	T	.....	.....	.....	.....
<i>F. succisae</i>	.....	T	.....	.....	.....	.....
<i>F. bulbicola</i>	.....	T	.....	.....	.....	.....
<i>Fusarium</i> sp. (NRRL25623)	.....	.....	.....	.....	.....	.....
<i>Fusarium</i> sp. (NRRL29123)	.....	.....	.....	.....	.....	.....
<i>Fusarium</i> sp. (NRRL29124)	.....	.....	.....	.....	.....	.....
<i>F. guttiforme</i>	.....	.....	.....	.....	.....	.....
<i>F. begoniae</i>	.....	.....	.....	.....	.....	.....
<i>F. fujikuroi</i> (MP-C)	.....	T	.....	.....	.....	.....
<i>F. proliferatum</i> (MP-D)	.....	T	.....	.....	.....	.....
<i>F. sacchari</i> (MP-B)	.....	T	.....	.....	.....	.....
<i>F. thapsinum</i> (MP-F)	.....	T	.....	.....	.....	.....
<i>F. verticillioides</i> (MP-A)	.....	T	.....	.....	.....	.....
<i>F. nygamai</i> (MP-G)	.....	T	.....	.....	.....	.....
<i>F. inflexum</i>	.....	T	.....	.....	.....	.....





	490	500	510	520	530	540
<b>Host = Teosinte</b>						
<i>F. subglutinans</i> (Fst10)	ACCCAAGTAG	TCTTTGCAGT	AAATGATGAA	TGCCATAGGT	TAGATCTGAG	TTGG-----T
<i>F. subglutinans</i> (Fst26)	.....	.....	.....	.....	.....	-----
<i>F. subglutinans</i> (Fst40)	.....	.....	.....	.....	.....	-----
<i>F. subglutinans</i> (Fst51)	.....	.....	.....	.....	.....	-----
<b>MP-E; Host = Maize</b>						
<i>F. subglutinans</i> (MRC714)	.....	.....	.....	.....	.....	-----
<i>F. subglutinans</i> (MRC756)	.....	.....	.....	.....	.....	-----
<i>F. subglutinans</i> (MRC1084)	.....	.....	.....	.....	.....	-----
<i>F. subglutinans</i> (MRC6483)N	.....	.....	.....	.....	.....	-----
<i>F. subglutinans</i> (MRC6512)	.....	.....	.....	.....	.....	-----
<b>MP-H; Host = Pine</b>						
<i>F. subglutinans</i> (MRC6213)	.....	.....	.....	.....	G	-.----A-
<i>F. subglutinans</i> (MRC7488)	.....	.....	.....	.....	G	-.----A-
<i>F. bactridioides</i>	.....	.....	.....	.....	T	-----
<i>Fusarium</i> sp. (NRRL25622)	.....	.....	.....	.....	.....	-----
<i>F. anthophilum</i>	.....	.....	.....	.....	G	-.----A-
<i>F. succisae</i>	.....	.....	.....	.....	G	-.----A-
<i>F. bulbicola</i>	.....	.....	.....	.....	GC	-.----A-
<i>Fusarium</i> sp. (NRRL25623)	.....	.....	.....	.....	G	-.----A-
<i>Fusarium</i> sp. (NRRL29123)	.....	.....	.....	.....	G	-.----A-
<i>Fusarium</i> sp. (NRRL29124)	.....	.....	.....	.....	G	-.----A-
<i>F. guttiforme</i>	.....	.....	.....	.....	G	-.----A-
<i>F. begoniae</i>	.....	.....	.....	.....	G	-.----A-
<i>F. fujikuroi</i> (MP-C)	.....	.....	.....	.....	G	-.GC---
<i>F. proliferatum</i> (MP-D)	.....	.....	.....	.....	G	-.GC---
<i>F. sacchari</i> (MP-B)	.....	.....	.....	.....	G	-.GC---
<i>F. thapsinum</i> (MP-F)	.....	.....	.....	.....	G	-.G----
<i>F. verticillioides</i> (MP-A)	.....	.....	.....	.....	G	-.G---T
<i>F. nygamai</i> (MP-G)	.....	.....	.....	.....	G	-.G----
<i>F. inflexum</i>	.....	.....	.....	.....	-	-.----CAAT

	550	560	570	580	590	600
<b>Host = Teosinte</b>						
<i>F. subglutinans</i> (Fst10)	AG-TC-TAGT	TGAG--TTAG	TTTA-CTAAA	CTAAT-GATC	TAT--ACA--	AG-----CCA
<i>F. subglutinans</i> (Fst26)	.....	.....	.....	.....	.....	-----
<i>F. subglutinans</i> (Fst40)	.....	.....	.....	.....	.....	-----
<i>F. subglutinans</i> (Fst51)	.....	.....	.....	.....	.....	-----
<b>MP-E; Host = Maize</b>						
<i>F. subglutinans</i> (MRC714)	.....	.....	.....	.....	.....	-----
<i>F. subglutinans</i> (MRC756)	.....	.....	.....	.....	.....	-----
<i>F. subglutinans</i> (MRC1084)	.....	.....	.....	.....	.....	-----
<i>F. subglutinans</i> (MRC6483)	.....	.....	.....	.....	.....	-----
<i>F. subglutinans</i> (MRC6512)	.....	.....	.....	.....	.....	-----
<b>MP-H; Host = Pine</b>						
<i>F. subglutinans</i> (MRC6213)	.....	.....	.....	.....	G--	-----
<i>F. subglutinans</i> (MRC7488)	.....	.....	.....	.....	G--	-----
<i>F. bactridioides</i>	.....	.....	.....	.....	.....	-----
<i>Fusarium</i> sp. (NRRL25622)	.....	.....	.....	.....	.....	-----
<i>F. anthophilum</i>	.....	.....	.....	.....	.....	-----A-----
<i>F. succisae</i>	.....	.....	.....	.....	.....	-----
<i>F. bulbicola</i>	.....	.....	.....	.....	-C-..--G	-----
<i>Fusarium</i> sp. (NRRL25623)	.....	.....	.....	.....	.....	-----
<i>Fusarium</i> sp. (NRRL29123)	.....	.....	.....	.....	.....	-----
<i>Fusarium</i> sp. (NRRL29124)	.....	.....	.....	.....	.....	-----
<i>F. guttiforme</i>	.....	.....	.....	.....	.....	-----
<i>F. begoniae</i>	.....	.....	.....	.....	.....	-----
<i>F. fujikuroi</i> (MP-C)	C-.....	.....	G-.....	.....	--G..--G	-----C...
<i>F. proliferatum</i> (MP-D)	C-.....	.....	G-.....	.....	--G..--G	-----C...
<i>F. sacchari</i> (MP-B)	C-.....	.....	G-.....	.....	--GG--TG	-----C...
<i>F. thapsinum</i> (MP-F)	..T.-G.....	.....	A.....	.....	..G-..-T-	..T-----
<i>F. verticillioides</i> (MP-A)	..-G.....	.....	G-.....	.....	..G-..-T-	..T-----
<i>F. nygamai</i> (MP-G)	.....	.....	A.....	.....	..G-..-T-	..T-----
<i>F. inflexum</i>	.....	CT..GG.....	..C-..G-.....	.....	..-G-..-T-	..TAAT-T..



610 620 630 640 650 660

**Host = Teosinte**

*F. subglutinans* (Fst10) GCC---TTA- -GATTTGGTC TATAAATGAA AGTGTAAGCA TTTCACTCA AGAGTAATGT  
*F. subglutinans* (Fst26) .....  
*F. subglutinans* (Fst40) .....  
*F. subglutinans* (Fst51) .....

**MP-E; Host = Maize**

*F. subglutinans* (MRC714) .....  
*F. subglutinans* (MRC756) .....  
*F. subglutinans* (MRC1084) .....  
*F. subglutinans* (MRC6483) .....  
*F. subglutinans* (MRC6512) .....

**MP-H; Host = Pine**

*F. subglutinans* (MRC6213) ...---A.- - .....  
*F. subglutinans* (MRC7488) ...---A.- - .....  
*F. bactridioides* .....  
*Fusarium* sp. (NRRL25622) .....  
*F. anthophilum* .....  
*F. succisae* .....  
*F. bulbicola* .....  
*Fusarium* sp. (NRRL25623) .....  
*Fusarium* sp. (NRRL29123) .....  
*Fusarium* sp. (NRRL29124) .....  
*F. guttiforme* .....  
*F. begoniae* .....  
*F. fujikuroi* (MP-C) -.G---.T - .....  
*F. proliferatum* (MP-D) -.G---.T - .....  
*F. sacchari* (MP-B) ---AA.T - .....  
*F. thapsinum* (MP-F) ---AA.T - .....  
*F. verticillioides* (MP-A) ---A.T - .....  
*F. nygamai* (MP-G) ---A.T - .....  
*F. inflexum* ---AAA..T C---.....

670 681

**Host = Teosinte**

*F. subglutinans* (Fst10) GGCAACGCAG GAACTGAAATC  
*F. subglutinans* (Fst26) .....  
*F. subglutinans* (Fst40) .....  
*F. subglutinans* (Fst51) .....

**MP-E; Host = Maize**

*F. subglutinans* (MRC714) .....  
*F. subglutinans* (MRC756) .....  
*F. subglutinans* (MRC1084) .....  
*F. subglutinans* (MRC6483) .....  
*F. subglutinans* (MRC6512) .....

**MP-H; Host = Pine**

*F. subglutinans* (MRC6213) .....  
*F. subglutinans* (MRC7488) .....  
*F. bactridioides* .....  
*Fusarium* sp. (NRRL25622) .....  
*F. anthophilum* .....  
*F. succisae* .....  
*F. bulbicola* .....  
*Fusarium* sp. (NRRL25623) .....  
*Fusarium* sp. (NRRL29123) .....  
*Fusarium* sp. (NRRL29124) .....  
*F. guttiforme* .....  
*F. begoniae* .....  
*F. fujikuroi* (MP-C) .....  
*F. proliferatum* (MP-D) .....  
*F. sacchari* (MP-B) .....  
*F. thapsinum* (MP-F) .....  
*F. verticillioides* (MP-A) .....  
*F. nygamai* (MP-G) .....  
*F. inflexum* .....

## APPENDIX 5

Aligned calmodulin,  $\beta$ -tubulin histone *H3* gene sequences, as well as the sequence for the three nuclear regions HB9, HB14 and HB26, for selected *Fusarium* strains in *Gibberella fujikuroi* mating population E (MP-E). These sequences were used to show that mating population E is separated in two cryptic species (Chapter 6 of this thesis). Nucleotides similar to those of isolate M3869 are indicated as dots, whereas nucleotide deletions are indicated by vertical lines (-).

### Calmodulin

	10	20	30	40	50	60
<i>F. subglutinans</i> (M3869)	TCAAGGAGGC	CTTCTCCCTC	TTTGTAAGCT	ATTCCCTTTG	TTTCGCCGCC	TTGCTTAGCC
<i>F. subglutinans</i> (M3935)	.....	.....	.....	.....	.....	.....
<i>F. subglutinans</i> (Fst9)	.....	.....	.....	.....	.....	.....
<i>F. subglutinans</i> (Fst10)	.....	.....	.....	..C.....	.....	.....
<i>F. subglutinans</i> (Fst13)	.....	.....	.....	..C.....	.....	.....
<i>F. subglutinans</i> (Fst17)	.....	.....	.....	..C.....	.....	.....
<i>F. subglutinans</i> (Fst22)	.....	.....	.....	..C.....	.....	.....
<i>F. subglutinans</i> (Fst26)	.....	.....	.....	.....	.....	.....
<i>F. subglutinans</i> (Fst40)	.....	.....	.....	..C.....	.....	.....
<i>F. subglutinans</i> (Fst51)	.....	.....	.....	.....	.....	.....
<i>F. subglutinans</i> (Fst54)	.....	.....	.....	.....	.....	.....
<i>F. subglutinans</i> (Fst58)	.....	.....	.....	.....	.....	.....
<i>F. subglutinans</i> (Fst69)	.....	.....	.....	.....	.....	.....
<i>F. subglutinans</i> (MRC115)	.....	.....	.....	..C.....	.....	.....
<i>F. subglutinans</i> (MRC714)	.....	.....	.....	..C.....	.....	.....
<i>F. subglutinans</i> (MRC756)	.....	.....	.....	.....	.....	.....
<i>F. subglutinans</i> (MRC837)	.....	.....	.....	.....	.....	.....
<i>F. subglutinans</i> (MRC1077)	.....	.....	.....	.....	.....	.....
<i>F. subglutinans</i> (MRC1084)	.....	.....	.....	.....	.....	.....
<i>F. subglutinans</i> (KSU434)	.....	.....	.....	..C.....	.....	.....
<i>F. subglutinans</i> (KSU507)	.....	.....	.....	..C.....	.....	.....
<i>F. subglutinans</i> (KSU731)	.....	.....	.....	..C.....	.....	.....
<i>F. subglutinans</i> (KSU993)	.....	.....	.....	..C.....	.....	.....
<i>F. subglutinans</i> (KSU1257)	.....	.....	.....	..C.....	.....	.....
<i>F. subglutinans</i> (KSU1417)	.....	.....	.....	..C.....	.....	.....
<i>F. subglutinans</i> (KSU2921)	.....	.....	.....	..C.....	.....	.....
<i>F. subglutinans</i> (KSU3851)	.....	.....	.....	..C.....	.....	.....
<i>F. subglutinans</i> (MRC6512)	.....	.....	.....	..C.....	.....	.....
<i>F. subglutinans</i> (MRC6483)	.....	.....	.....	..C.....	.....	.....



	70	80	90	100	110	120
<i>F. subglutinans</i> (M3869)	GTGTCCTTGCT	AGAAGCTGTC	GCTAACCTCT	TTATCCAGGA	CAAGGATGGC	GATGGTGAGT
<i>F. subglutinans</i> (M3935)	.....	.....	.....	.....	.....	.....
<i>F. subglutinans</i> (Fst9)	.....	.....	.....	.....	.....	.....
<i>F. subglutinans</i> (Fst10)	.....	.....	.....	.....	.....	.....
<i>F. subglutinans</i> (Fst13)	.....	.....	.....	.....	.....	.....
<i>F. subglutinans</i> (Fst17)	.....	.....	.....	.....	.....	.....
<i>F. subglutinans</i> (Fst22)	.....	.....	.....	.....	.....	.....
<i>F. subglutinans</i> (Fst26)	.....	.....	.....	.....	.....	.....
<i>F. subglutinans</i> (Fst40)	.....	.....	.....	.....	.....	.....
<i>F. subglutinans</i> (Fst51)	.....	.....	.....	.....	.....	.....
<i>F. subglutinans</i> (Fst54)	.....	.....	.....	.....	.....	.....
<i>F. subglutinans</i> (Fst58)	.....	.....	.....	.....	.....	.....
<i>F. subglutinans</i> (Fst69)	.....	.....	.....	.....	.....	.....
<i>F. subglutinans</i> (MRC115)	.....	.....	.....	.....	.....	.....
<i>F. subglutinans</i> (MRC714)	.....	.....	.....	.....	.....	.....
<i>F. subglutinans</i> (MRC756)	.....	.....	.....	.....	.....	.....
<i>F. subglutinans</i> (MRC837)	.....	.....	.....	.....	.....	.....
<i>F. subglutinans</i> (MRC1077)	.....	.....	.....	.....	.....	.....
<i>F. subglutinans</i> (MRC1084)	.....	.....	.....	.....	.....	.....
<i>F. subglutinans</i> (KSU434)	.....	.....	.....	.....	.....	.....
<i>F. subglutinans</i> (KSU507)	.....	.....	.....	.....	.....	.....
<i>F. subglutinans</i> (KSU731)	.....	.....	.....	.....	.....	.....
<i>F. subglutinans</i> (KSU993)	.....	.....	.....	.....	.....	.....
<i>F. subglutinans</i> (KSU1257)	.....	.....	.....	.....	.....	.....
<i>F. subglutinans</i> (KSU1417)	.....	.....	.....	.....	.....	.....
<i>F. subglutinans</i> (KSU2921)	.....	.....	.....	.....	.....	.....
<i>F. subglutinans</i> (KSU3851)	.....	.....	.....	.....	.....	.....
<i>F. subglutinans</i> (MRC6512)	.....	.....	.....	.....	.....	.....
<i>F. subglutinans</i> (MRC6483)	.....	.....	.....	.....	.....	.....

	130	140	150	160	170	180
<i>F. subglutinans</i> (M3869)	GATGCTCCCC	TTCCGCGAT	GTTTCTTCGT	TGGCCCCGTG	CGAAACCCAA	ATCGATCCAA
<i>F. subglutinans</i> (M3935)	.....	.....	.....	.....	.....	.....
<i>F. subglutinans</i> (Fst9)	.....	.....	.....	.....	.....	.....
<i>F. subglutinans</i> (Fst10)	.....	.....	.....	.....	.....	.....
<i>F. subglutinans</i> (Fst13)	.....	.....	.....	.....	.....	.....
<i>F. subglutinans</i> (Fst17)	.....	.....	.....	.....	.....	.....
<i>F. subglutinans</i> (Fst22)	.....	.....	.....	.....	.....	.....
<i>F. subglutinans</i> (Fst26)	.....	.....	.....	.....	.....	.....
<i>F. subglutinans</i> (Fst40)	.....	.....	.....	.....	.....	.....
<i>F. subglutinans</i> (Fst51)	.....	.....	.....	.....	.....	.....
<i>F. subglutinans</i> (Fst54)	.....	.....	.....	.....	.....	.....
<i>F. subglutinans</i> (Fst58)	.....	.....	.....	.....	.....	.....
<i>F. subglutinans</i> (Fst69)	.....	.....	.....	.....	.....	.....
<i>F. subglutinans</i> (MRC115)	.....	.....	.....	.....	.....	.....
<i>F. subglutinans</i> (MRC714)	.....	.....	.....	.....	.....	.....
<i>F. subglutinans</i> (MRC756)	.....	.....	.....	.....	.....	.....
<i>F. subglutinans</i> (MRC837)	.....	.....	.....	.....	.....	.....
<i>F. subglutinans</i> (MRC1077)	.....	.....	.....	.....	.....	.....
<i>F. subglutinans</i> (MRC1084)	.....	.....	.....	.....	.....	.....
<i>F. subglutinans</i> (KSU434)	.....	.....	.....	.....	.....	.....
<i>F. subglutinans</i> (KSU507)	.....	.....	.....	.....	.....	.....
<i>F. subglutinans</i> (KSU731)	.....	.....	.....	.....	.....	.....
<i>F. subglutinans</i> (KSU993)	.....	.....	.....	.....	.....	.....
<i>F. subglutinans</i> (KSU1257)	.....	.....	.....	.....	.....	.....
<i>F. subglutinans</i> (KSU1417)	.....	.....	.....	.....	.....	.....
<i>F. subglutinans</i> (KSU2921)	.....	.....	.....	.....	.....	.....
<i>F. subglutinans</i> (KSU3851)	.....	.....	.....	.....	.....	.....
<i>F. subglutinans</i> (MRC6512)	.....	.....	.....	.....	.....	.....
<i>F. subglutinans</i> (MRC6483)	.....	.....	.....	.....	.....	.....



	190	200	210	220	230	240
<i>F. subglutinans</i> (M3869)	CAAAGCATGC	ATCAGACCAC	TATAATCCTC	TACATCTCTG	TCTATGCGAT	ATTCTTAAAT
<i>F. subglutinans</i> (M3935)	.....	.....	.....	.....	.....	.....
<i>F. subglutinans</i> (Fst9)	.....	.....	.....	.....	.....	.....
<i>F. subglutinans</i> (Fst10)	.....	.....	.....	.....	.....	.....
<i>F. subglutinans</i> (Fst13)	.....	.....	.....	.....	.....	.....
<i>F. subglutinans</i> (Fst17)	.....	.....	.....	.....	.....	.....
<i>F. subglutinans</i> (Fst22)	.....	.....	.....	.....	.....	.....
<i>F. subglutinans</i> (Fst26)	.....	.....	.....	.....	.....	.....
<i>F. subglutinans</i> (Fst40)	.....	.....	.....	.....	.....	.....
<i>F. subglutinans</i> (Fst51)	.....	.....	.....	.....	.....	.....
<i>F. subglutinans</i> (Fst54)	.....	.....	.....	.....	.....	.....
<i>F. subglutinans</i> (Fst58)	.....	.....	.....	.....	.....	.....
<i>F. subglutinans</i> (Fst69)	.....	.....	.....	.....	.....	.....
<i>F. subglutinans</i> (MRC115)	.....	.....	.....	.....	.....	.....
<i>F. subglutinans</i> (MRC714)	.....	.....	.....	.....	.....	.....
<i>F. subglutinans</i> (MRC756)	.....	.....	.....	.....	.....	.....
<i>F. subglutinans</i> (MRC837)	.....	.....	.....	.....	.....	.....
<i>F. subglutinans</i> (MRC1077)	.....	.....	.....	.....	.....	.....
<i>F. subglutinans</i> (MRC1084)	.....	.....	.....	.....	.....	.....
<i>F. subglutinans</i> (KSU434)	.....	.....	.....	.....	.....	.....
<i>F. subglutinans</i> (KSU507)	.....	.....	.....	.....	.....	.....
<i>F. subglutinans</i> (KSU731)	.....	.....	.....	.....	.....	.....
<i>F. subglutinans</i> (KSU993)	.....	.....	.....	.....	.....	.....
<i>F. subglutinans</i> (KSU1257)	.....	.....	.....	.....	.....	.....
<i>F. subglutinans</i> (KSU1417)	.....	.....	.....	.....	.....	.....
<i>F. subglutinans</i> (KSU2921)	.....	.....	.....	.....	.....	.....
<i>F. subglutinans</i> (KSU3851)	.....	.....	.....	.....	.....	.....
<i>F. subglutinans</i> (MRC6512)	.....	.....	.....	.....	.....	.....
<i>F. subglutinans</i> (MRC6483)	.....	.....	.....	.....	.....	.....

	250	260	270	280	290	300
<i>F. subglutinans</i> (M3869)	CGAAAGCATG	AGCTAAACGC	CTCGCTCTAG	GCCAAATTAC	CACTAAGGAG	CTCGGTACCG
<i>F. subglutinans</i> (M3935)	.....	.....	.....	.....	.....	.....
<i>F. subglutinans</i> (Fst9)	.....	.....	.....	.....	.....	.....
<i>F. subglutinans</i> (Fst10)	.....	.....	.....	.....	.....	.....
<i>F. subglutinans</i> (Fst13)	.....	.....	.....	.....	.....	.....
<i>F. subglutinans</i> (Fst17)	.....	.....	.....	.....	.....	.....
<i>F. subglutinans</i> (Fst22)	.....	.....	.....	.....	.....	.....
<i>F. subglutinans</i> (Fst26)	.....	.....	.....	.....	.....	.....
<i>F. subglutinans</i> (Fst40)	.....	.....	.....	.....	.....	.....
<i>F. subglutinans</i> (Fst51)	.....	.....	.....	.....	.....	.....
<i>F. subglutinans</i> (Fst54)	.....	.....	.....	.....	.....	.....
<i>F. subglutinans</i> (Fst58)	.....	.....	.....	.....	.....	.....
<i>F. subglutinans</i> (Fst69)	.....	.....	.....	.....	.....	.....
<i>F. subglutinans</i> (MRC115)	.....	.....	.....	.....	.....	.....
<i>F. subglutinans</i> (MRC714)	.....	.....	.....	.....	.....	.....
<i>F. subglutinans</i> (MRC756)	.....	.....	.....	.....	.....	.....
<i>F. subglutinans</i> (MRC837)	.....	.....	.....	.....	.....	.....
<i>F. subglutinans</i> (MRC1077)	.....	.....	.....	.....	.....	.....
<i>F. subglutinans</i> (MRC1084)	.....	.....	.....	.....	.....	.....
<i>F. subglutinans</i> (KSU434)	.....	.....	.....	.....	.....	.....
<i>F. subglutinans</i> (KSU507)	.....	.....	.....	.....	.....	.....
<i>F. subglutinans</i> (KSU731)	.....	.....	.....	.....	.....	.....
<i>F. subglutinans</i> (KSU993)	.....	.....	.....	.....	.....	.....
<i>F. subglutinans</i> (KSU1257)	.....	.....	.....	.....	.....	.....
<i>F. subglutinans</i> (KSU1417)	.....	.....	.....	.....	.....	.....
<i>F. subglutinans</i> (KSU2921)	.....	.....	.....	.....	.....	.....
<i>F. subglutinans</i> (KSU3851)	.....	.....	.....	.....	.....	.....
<i>F. subglutinans</i> (MRC6512)	.....	.....	.....	.....	.....	.....
<i>F. subglutinans</i> (MRC6483)	.....	.....	.....	.....	.....	.....





	310	320	330	340	350	360
<i>F. subglutinans</i> (M3869)	TTATGCGCTC	TCTCGGCCAG	AACCCCTCCG	AGTCTGAGCT	TCAGGACATG	ATCAACGAGG
<i>F. subglutinans</i> (M3935)	.....	.....	.....	.....	.....	.....
<i>F. subglutinans</i> (Fst9)	.....	.....	.....	.....	.....	.....
<i>F. subglutinans</i> (Fst10)	.....	.....	.....	.....	.....	.....
<i>F. subglutinans</i> (Fst13)	.....	.....	.....	.....	.....	.....
<i>F. subglutinans</i> (Fst17)	.....	.....	.....	.....	.....	.....
<i>F. subglutinans</i> (Fst22)	.....	.....	.....	.....	.....	.....
<i>F. subglutinans</i> (Fst26)	.....	.....	.....	.....	.....	.....
<i>F. subglutinans</i> (Fst40)	.....	.....	.....	.....	.....	.....
<i>F. subglutinans</i> (Fst51)	.....	.....	.....	.....	.....	.....
<i>F. subglutinans</i> (Fst54)	.....	.....	.....	.....	.....	.....
<i>F. subglutinans</i> (Fst58)	.....	.....	.....	.....	.....	.....
<i>F. subglutinans</i> (Fst69)	.....	.....	.....	.....	.....	.....
<i>F. subglutinans</i> (MRC115)	.....	.....	.....	.....	.....	.....
<i>F. subglutinans</i> (MRC714)	.....	.....	.....	.....	.....	.....
<i>F. subglutinans</i> (MRC756)	.....	.....	.....	.....	.....	.....
<i>F. subglutinans</i> (MRC837)	.....	.....	.....	.....	.....	.....
<i>F. subglutinans</i> (MRC1077)	.....	.....	.....	.....	.....	.....
<i>F. subglutinans</i> (MRC1084)	.....	.....	.....	.....	.....	.....
<i>F. subglutinans</i> (KSU434)	.....	.....	.....	.....	.....	.....
<i>F. subglutinans</i> (KSU507)	.....	.....	.....	.....	.....	.....
<i>F. subglutinans</i> (KSU731)	.....	.....	.....	.....	.....	.....
<i>F. subglutinans</i> (KSU993)	.....	.....	.....	.....	.....	.....
<i>F. subglutinans</i> (KSU1257)	.....	.....	.....	.....	.....	.....
<i>F. subglutinans</i> (KSU1417)	.....	.....	.....	.....	.....	.....
<i>F. subglutinans</i> (KSU2921)	.....	.....	.....	.....	.....	.....
<i>F. subglutinans</i> (KSU3851)	.....	.....	.....	.....	.....	.....
<i>F. subglutinans</i> (MRC6512)	.....	.....	.....	.....	.....	.....
<i>F. subglutinans</i> (MRC6483)	.....	.....	.....	.....	.....	.....

	370	380	390	400	410	420
<i>F. subglutinans</i> (M3869)	TTGACGCCGA	CAATAACGGC	ACCATCGACT	TTCCTGGTGC	GTAGTATTCC	AAGGCGATCA
<i>F. subglutinans</i> (M3935)	.....	.....	.....	.....	.....	.....
<i>F. subglutinans</i> (Fst9)	.....	.....	.....	.....	.....	.....
<i>F. subglutinans</i> (Fst10)	.....	.....	.....	.....	.....	.....
<i>F. subglutinans</i> (Fst13)	.....	.....	.....	.....	.....	.....
<i>F. subglutinans</i> (Fst17)	.....	.....	.....	.....	.....	.....
<i>F. subglutinans</i> (Fst22)	.....	.....	.....	.....	.....	.....
<i>F. subglutinans</i> (Fst26)	.....	.....	.....	.....	.....	.....
<i>F. subglutinans</i> (Fst40)	.....	.....T.....	.....	.....	.....	.....
<i>F. subglutinans</i> (Fst51)	.....	.....	.....	.....	.....	.....
<i>F. subglutinans</i> (Fst54)	.....	.....	.....	.....	.....	.....
<i>F. subglutinans</i> (Fst58)	.....	.....	.....	.....	.....	.....
<i>F. subglutinans</i> (Fst69)	.....	.....	.....	.....	.....	.....
<i>F. subglutinans</i> (MRC115)	.....	.....	.....	.....	.....	.....
<i>F. subglutinans</i> (MRC714)	.....	.....T.....	.....	.....	.....	.....
<i>F. subglutinans</i> (MRC756)	.....	.....	.....	.....	.....	.....
<i>F. subglutinans</i> (MRC837)	.....	.....	.....	.....	.....	.....
<i>F. subglutinans</i> (MRC1077)	.....	.....	.....	.....	.....	.....
<i>F. subglutinans</i> (MRC1084)	.....	.....	.....	.....	.....	.....
<i>F. subglutinans</i> (KSU434)	.....	.....T.....	.....	.....	.....	.....
<i>F. subglutinans</i> (KSU507)	.....	.....T.....	.....	.....	.....	.....
<i>F. subglutinans</i> (KSU731)	.....	.....T.....	.....	.....	.....	.....
<i>F. subglutinans</i> (KSU993)	.....	.....T.....	.....	.....	.....	.....
<i>F. subglutinans</i> (KSU1257)	.....	.....	.....	.....	.....	.....
<i>F. subglutinans</i> (KSU1417)	.....	.....	.....	.....	.....	.....
<i>F. subglutinans</i> (KSU2921)	.....	.....T.....	.....	.....	.....	.....
<i>F. subglutinans</i> (KSU3851)	.....	.....	.....	.....	.....	.....
<i>F. subglutinans</i> (MRC6512)	.....	.....T.....	.....	.....	.....	.....
<i>F. subglutinans</i> (MRC6483)	.....	.....T.....	.....	.....	.....	.....



	430	440	450	460	470	480
<i>F. subglutinans</i> (M3869)	GAGGACGGTC	AGTACTAACC	ACTGGGTAAA	GAGTTCCTCA	CCATGATGGC	CAGAAAGATG
<i>F. subglutinans</i> (M3935)	.....	.....	.....	.....	.....	.....
<i>F. subglutinans</i> (Fst9)	.....	.....	.....	.....	.....	.....
<i>F. subglutinans</i> (Fst10)	.....	.....	.....	.....	.....	.....
<i>F. subglutinans</i> (Fst13)	.....	.....	.....	.....	.....	.....
<i>F. subglutinans</i> (Fst17)	.....	.....	.....	.....	.....	.....
<i>F. subglutinans</i> (Fst22)	.....	.....	.....	.....	.....	.....
<i>F. subglutinans</i> (Fst26)	.....	.....	.....	.....	.....	.....
<i>F. subglutinans</i> (Fst40)	.....	.....	.....	.....	.....	.....
<i>F. subglutinans</i> (Fst51)	.....	.....	.....	.....	.....	.....
<i>F. subglutinans</i> (Fst54)	.....	.....	.....	.....	.....	.....
<i>F. subglutinans</i> (Fst58)	.....	.....	.....	.....	.....	.....
<i>F. subglutinans</i> (Fst69)	.....	.....	.....	.....	.....	.....
<i>F. subglutinans</i> (MRC115)	.....	.....	.....	.....	.....	.....
<i>F. subglutinans</i> (MRC714)	.....	.....	.....	.....	.....	.....
<i>F. subglutinans</i> (MRC756)	.....	.....	.....	.....	.....	.....
<i>F. subglutinans</i> (MRC837)	.....	.....	.....	.....	.....	.....
<i>F. subglutinans</i> (MRC1077)	.....	.....	.....	.....	.....	.....
<i>F. subglutinans</i> (MRC1084)	.....	.....	.....	.....	.....	.....
<i>F. subglutinans</i> (KSU434)	.....	.....	.....	.....	.....	.....
<i>F. subglutinans</i> (KSU507)	.....	.....	.....	.....	.....	.....
<i>F. subglutinans</i> (KSU731)	.....	.....	.....	.....	.....	.....
<i>F. subglutinans</i> (KSU993)	.....	.....	.....	.....	.....	.....
<i>F. subglutinans</i> (KSU1257)	.....	.....	.....	.....	.....	.....
<i>F. subglutinans</i> (KSU1417)	.....	.....	.....	.....	.....	.....
<i>F. subglutinans</i> (KSU2921)	.....	.....	.....	.....	.....	.....
<i>F. subglutinans</i> (KSU3851)	.....	.....	.....	.....	.....	.....
<i>F. subglutinans</i> (MRC6512)	.....	.....	.....	.....	.....	.....
<i>F. subglutinans</i> (MRC6483)	.....	.....	.....	.....	.....	.....



**Partial  $\beta$ -tubulin (exons 2 and 3)**

	10	20	30	40	50	60
<i>F. subglutinans</i> (M3869)	CAAATCGGTG	CTGCTTCTG	GCAAACCATC	TC <del>T</del> GGCGAGC	ACGGCCTCGA	CAGCAATGGT
<i>F. subglutinans</i> (M3935)	.....	.....	.....	.....	.....	.....
<i>F. subglutinans</i> (Fst9)	.....	.....	.....	.....	.....	.....
<i>F. subglutinans</i> (Fst10)	.....	.....	.....	.....	.....	.....
<i>F. subglutinans</i> (Fst13)	.....	.....	.....	.....	.....	.....
<i>F. subglutinans</i> (Fst17)	.....	.....	.....	.....	.....	.....
<i>F. subglutinans</i> (Fst22)	.....	.....	.....	.....	.....	.....
<i>F. subglutinans</i> (Fst26)	.....	.....	.....	.....	.....	.....
<i>F. subglutinans</i> (Fst40)	.....	.....	.....	.....	.....	.....
<i>F. subglutinans</i> (Fst51)	.....	.....	.....	.....	.....	.....
<i>F. subglutinans</i> (Fst54)	.....	.....	.....	.....	.....	.....
<i>F. subglutinans</i> (Fst58)	.....	.....	.....	.....	.....	.....
<i>F. subglutinans</i> (Fst69)	.....	.....	.....	.....	.....	.....
<i>F. subglutinans</i> (MRC115)	.....	.....	.....	.....	.....	.....
<i>F. subglutinans</i> (MRC714)	.....	.....	.....	.....	.....	.....
<i>F. subglutinans</i> (MRC756)	.....	.....	.....	.....	.....	.....
<i>F. subglutinans</i> (MRC837)	.....	.....	.....	.....	.....	.....
<i>F. subglutinans</i> (MRC1077)	.....	.....	.....	.....	.....	.....
<i>F. subglutinans</i> (MRC1084)	.....	.....	.....	.....	.....	.....
<i>F. subglutinans</i> (KSU434)	.....	.....	.....	.....	.....	.....
<i>F. subglutinans</i> (KSU507)	.....	.....	.....	.....	.....	.....
<i>F. subglutinans</i> (KSU731)	.....	.....	.....	.....	.....	.....
<i>F. subglutinans</i> (KSU993)	.....	.....	.....	.....	.....	.....
<i>F. subglutinans</i> (KSU1257)	.....	.....	.....	.....	.....	.....
<i>F. subglutinans</i> (KSU1417)	nnnnnnnnnn	nnnnnnnnnn	nn.....	.....	.....	.....
<i>F. subglutinans</i> (KSU2921)	.....	.....	.....	.....	.....	.....
<i>F. subglutinans</i> (KSU3851)	.....	.....	.....	.....	.....	.....
<i>F. subglutinans</i> (MRC6512)	.....	.....	.....	.....	.....	.....
<i>F. subglutinans</i> (MRC6483)	.....	.....	.....	.....	.....	.....

	70	80	90	100	110	120
<i>F. subglutinans</i> (M3869)	GTCTACAACG	GTACCTCCGA	GCTCCAGCTC	GAGCGTATGA	GTGTCTACTT	CAACGAGGTA
<i>F. subglutinans</i> (M3935)	.....	.....	.....	.....	.....	.....
<i>F. subglutinans</i> (Fst9)	.....	.....	.....	.....	.....	.....
<i>F. subglutinans</i> (Fst10)	.....	.....	.....	.....	.....	.....
<i>F. subglutinans</i> (Fst13)	.....	.....	.....	.....	.....	.....
<i>F. subglutinans</i> (Fst17)	.....	.....	.....	.....	.....	.....
<i>F. subglutinans</i> (Fst22)	.....	.....	.....	.....	.....	.....
<i>F. subglutinans</i> (Fst26)	.....	.....	.....	.....	.....	.....
<i>F. subglutinans</i> (Fst40)	.....	.....	.....	.....	.....	.....
<i>F. subglutinans</i> (Fst51)	.....	.....	.....	.....	.....	.....
<i>F. subglutinans</i> (Fst54)	.....	.....	.....	.....	.....	.....
<i>F. subglutinans</i> (Fst58)	.....	.....	.....	.....	.....	.....
<i>F. subglutinans</i> (Fst69)	.....	.....	.....	.....	.....	.....
<i>F. subglutinans</i> (MRC115)	.....	.....	.....	.....	.....	.....
<i>F. subglutinans</i> (MRC714)	.....	.....	.....	.....	.....	.....
<i>F. subglutinans</i> (MRC756)	.....	.....	.....	.....	.....	.....
<i>F. subglutinans</i> (MRC837)	.....	.....	.....	.....	.....	.....
<i>F. subglutinans</i> (MRC1077)	.....	.....	.....	.....	.....	.....
<i>F. subglutinans</i> (MRC1084)	.....	.....	.....	.....	.....	.....
<i>F. subglutinans</i> (KSU434)	.....	.....	.....	.....	.....	.....
<i>F. subglutinans</i> (KSU507)	.....	.....	.....	.....	.....	.....
<i>F. subglutinans</i> (KSU731)	.....	.....	.....	.....	.....	.....
<i>F. subglutinans</i> (KSU993)	.....	.....	.....	.....	.....	.....
<i>F. subglutinans</i> (KSU1257)	.....	.....	.....	.....	.....	.....
<i>F. subglutinans</i> (KSU1417)	.....	.....	.....	.....	.....	.....
<i>F. subglutinans</i> (KSU2921)	.....	.....	.....	.....	.....	.....
<i>F. subglutinans</i> (KSU3851)	.....	.....	.....	.....	.....	.....
<i>F. subglutinans</i> (MRC6512)	.....	.....	.....	.....	.....	.....
<i>F. subglutinans</i> (MRC6483)	.....	.....	.....	.....	.....	.....



	130	140	150	160	170	180
<i>F. subglutinans</i> (M3869)	TGCTTTAACA	GTCAATGCCA	AGAGTTCCCA	AGCTCACACA	ACTAGGCCTC	TGGCAACAAG
<i>F. subglutinans</i> (M3935)	.....	.....	.....	.....	.....	.....
<i>F. subglutinans</i> (Fst9)	.....	.....	A.....	.....	.....	.....
<i>F. subglutinans</i> (Fst10)	.....	.....	A.....	.....	.....	.....
<i>F. subglutinans</i> (Fst13)	.....	.....	A.....	.....	.....	.....
<i>F. subglutinans</i> (Fst17)	.....	.....	A.....	.....	.....	.....
<i>F. subglutinans</i> (Fst22)	.....	.....	A.....	.....	.....	.....
<i>F. subglutinans</i> (Fst26)	.....	.....	A.....	.....	.....	.....
<i>F. subglutinans</i> (Fst40)	.....	.....	A.....	.....	.....	.....
<i>F. subglutinans</i> (Fst51)	.....	.....	A.....	.....	.....	.....
<i>F. subglutinans</i> (Fst54)	.....	.....	A.....	.....	.....	.....
<i>F. subglutinans</i> (Fst58)	.....	.....	.....	.....	.....	.....
<i>F. subglutinans</i> (Fst69)	.....	.....	.....	.....	.....	.....
<i>F. subglutinans</i> (MRC115)	.....	.....	A.....	.....	.....	.....
<i>F. subglutinans</i> (MRC714)	.....	.....	A.....	.....	.....	.....
<i>F. subglutinans</i> (MRC756)	.....	.....	.....	.....	.....	.....
<i>F. subglutinans</i> (MRC837)	.....	.....	A.....	.....	.....	.....
<i>F. subglutinans</i> (MRC1077)	.....	.....	A.....	.....	.....	.....
<i>F. subglutinans</i> (MRC1084)	.....	.....	A.....	.....	.....	.....
<i>F. subglutinans</i> (KSU434)	.....	.....	A.....	.....	.....	.....
<i>F. subglutinans</i> (KSU507)	.....	.....	A.....	.....	.....	.....
<i>F. subglutinans</i> (KSU731)	.....	.....	A.....	.....	.....	.....
<i>F. subglutinans</i> (KSU993)	.....	.....	A.....	.....	.....	.....
<i>F. subglutinans</i> (KSU1257)	.....	.....	A.....	.....	.....	.....
<i>F. subglutinans</i> (KSU1417)	.....	.....	A.....	.....	.....	.....
<i>F. subglutinans</i> (KSU2921)	.....	.....	A.....	.....	.....	.....
<i>F. subglutinans</i> (KSU3851)	.....	.....	A.....	.....	.....	.....
<i>F. subglutinans</i> (MRC6512)	.....	.....	A.....	.....	.....	.....
<i>F. subglutinans</i> (MRC6483)	.....	.....	A.....	.....	.....	.....

	190	200	210	220	230	240
<i>F. subglutinans</i> (M3869)	TATGTTCCCC	GAGCCGTCCT	CGTTGATCTT	GAGCCTGGTA	CCATGGACGC	CGTCCGAGCT
<i>F. subglutinans</i> (M3935)	.....	.....	.....	.....	.....	.....
<i>F. subglutinans</i> (Fst9)	.....	.....	.....	.....	.....	.....
<i>F. subglutinans</i> (Fst10)	.....	.....	C.....	.....	.....	.....
<i>F. subglutinans</i> (Fst13)	.....	.....	C.....	.....	.....	.....
<i>F. subglutinans</i> (Fst17)	.....	.....	C.....	.....	.....	.....
<i>F. subglutinans</i> (Fst22)	.....	.....	C.....	.....	.....	.....
<i>F. subglutinans</i> (Fst26)	.....	.....	.....	.....	.....	.....
<i>F. subglutinans</i> (Fst40)	.....	.....	C.....	.....	.....	.....
<i>F. subglutinans</i> (Fst51)	.....	.....	.....	.....	.....	.....
<i>F. subglutinans</i> (Fst54)	.....	.....	.....	.....	.....	.....
<i>F. subglutinans</i> (Fst58)	.....	.....	.....	.....	.....	.....
<i>F. subglutinans</i> (Fst69)	.....	.....	.....	.....	.....	.....
<i>F. subglutinans</i> (MRC115)	.....	.....	C.....	.....	.....	.....
<i>F. subglutinans</i> (MRC714)	.....	.....	C.....	.....	.....	.....
<i>F. subglutinans</i> (MRC756)	.....	.....	.....	.....	.....	.....
<i>F. subglutinans</i> (MRC837)	.....	.....	.....	.....	.....	.....
<i>F. subglutinans</i> (MRC1077)	.....	.....	.....	.....	.....	.....
<i>F. subglutinans</i> (MRC1084)	.....	.....	.....	.....	.....	.....
<i>F. subglutinans</i> (KSU434)	.....	.....	C.....	.....	.....	.....
<i>F. subglutinans</i> (KSU507)	.....	.....	C.....	.....	.....	.....
<i>F. subglutinans</i> (KSU731)	.....	.....	C.....	.....	.....	.....
<i>F. subglutinans</i> (KSU993)	.....	.....	C.....	.....	.....	.....
<i>F. subglutinans</i> (KSU1257)	.....	.....	C.....	.....	.....	.....
<i>F. subglutinans</i> (KSU1417)	.....	.....	C.....	.....	.....	.....
<i>F. subglutinans</i> (KSU2921)	.....	.....	C.....	.....	.....	.....
<i>F. subglutinans</i> (KSU3851)	.....	.....	C.....	.....	.....	.....
<i>F. subglutinans</i> (MRC6512)	.....	.....	C.....	.....	.....	.....
<i>F. subglutinans</i> (MRC6483)	.....	.....	C.....	.....	.....	.....



	250	260	270	280	290	300
<i>F. subglutinans</i> (M3869)	GGTCCCTTCG	GTCAGCTCTT	CCGTCCCGAC	AACTTCGTTT	TCGGTCAGTC	CGGTGCTGGA
<i>F. subglutinans</i> (M3935)	.....	.....	.....	.....	.....	.....
<i>F. subglutinans</i> (Fst9)	.....	.....	.....	.....	.....	.....
<i>F. subglutinans</i> (Fst10)	.....	.....	.....	.....	.....	.....
<i>F. subglutinans</i> (Fst13)	.....	.....	.....	.....	.....	.....
<i>F. subglutinans</i> (Fst17)	.....	.....	.....	.....	.....	.....
<i>F. subglutinans</i> (Fst22)	.....	.....	.....	.....	.....	.....
<i>F. subglutinans</i> (Fst26)	.....	.....	.....	.....	.....	.....
<i>F. subglutinans</i> (Fst40)	.....	.....	.....	.....	.....	.....
<i>F. subglutinans</i> (Fst51)	.....	.....	.....	.....	.....	.....
<i>F. subglutinans</i> (Fst54)	.....	.....	.....	.....	.....	.....
<i>F. subglutinans</i> (Fst58)	.....	.....	.....	.....	.....	.....
<i>F. subglutinans</i> (Fst69)	.....	.....	.....	.....	.....	.....
<i>F. subglutinans</i> (MRC115)	.....	.....	.....	.....	.....	.....
<i>F. subglutinans</i> (MRC714)	.....	.....	.....	.....	.....	.....
<i>F. subglutinans</i> (MRC756)	.....	.....	.....	.....	.....	.....
<i>F. subglutinans</i> (MRC837)	.....	.....	.....	.....	.....	.....
<i>F. subglutinans</i> (MRC1077)	.....	.....	.....	.....	.....	.....
<i>F. subglutinans</i> (MRC1084)	.....	.....	.....	.....	.....	.....
<i>F. subglutinans</i> (KSU434)	.....	.....	.....	.....	.....	.....
<i>F. subglutinans</i> (KSU507)	.....	.....	.....	.....	.....	.....
<i>F. subglutinans</i> (KSU731)	.....	.....	.....	.....	.....	.....
<i>F. subglutinans</i> (KSU993)	.....	.....	.....	.....	.....	.....
<i>F. subglutinans</i> (KSU1257)	.....	.....	.....	.....	.....	.....
<i>F. subglutinans</i> (KSU1417)	.....	.....	.....	.....	.....	.....
<i>F. subglutinans</i> (KSU2921)	.....	.....	.....	.....	.....	.....
<i>F. subglutinans</i> (KSU3851)	.....	.....	.....	.....	.....	.....
<i>F. subglutinans</i> (MRC6512)	.....	.....	.....	.....	.....	.....
<i>F. subglutinans</i> (MRC6483)	.....	.....	.....	.....	.....	.....

	310	320	332
<i>F. subglutinans</i> (M3869)	AACAACCTGGG	CCAAGGGTCA	CTACACTGAGGG
<i>F. subglutinans</i> (M3935)	.....	.....	.....
<i>F. subglutinans</i> (Fst9)	.....	.....	.....
<i>F. subglutinans</i> (Fst10)	.....	.....	.....
<i>F. subglutinans</i> (Fst13)	.....	.....	.....
<i>F. subglutinans</i> (Fst17)	.....	.....	.....
<i>F. subglutinans</i> (Fst22)	.....	.....	.....
<i>F. subglutinans</i> (Fst26)	.....	.....	.....
<i>F. subglutinans</i> (Fst40)	.....	.....	.....
<i>F. subglutinans</i> (Fst51)	.....	.....	.....
<i>F. subglutinans</i> (Fst54)	.....	.....	.....
<i>F. subglutinans</i> (Fst58)	.....	.....	.....
<i>F. subglutinans</i> (Fst69)	.....	.....	.....
<i>F. subglutinans</i> (MRC115)	.....	.....	.....
<i>F. subglutinans</i> (MRC714)	.....	.....	.....
<i>F. subglutinans</i> (MRC756)	.....	.....	.....
<i>F. subglutinans</i> (MRC837)	.....	.....	.....
<i>F. subglutinans</i> (MRC1077)	.....	.....	.....
<i>F. subglutinans</i> (MRC1084)	.....	.....	.....
<i>F. subglutinans</i> (KSU434)	.....	.....	.....
<i>F. subglutinans</i> (KSU507)	.....	.....	.....
<i>F. subglutinans</i> (KSU731)	.....	.....	.....
<i>F. subglutinans</i> (KSU993)	.....	.....	.....
<i>F. subglutinans</i> (KSU1257)	.....	.....	.....
<i>F. subglutinans</i> (KSU1417)	.....	.....	.....
<i>F. subglutinans</i> (KSU2921)	.....	.....	.....
<i>F. subglutinans</i> (KSU3851)	.....	.....	.....
<i>F. subglutinans</i> (MRC6512)	.....	.....	.....
<i>F. subglutinans</i> (MRC6483)	.....	.....	.....





### Histone H3

	10	20	30	40	50	60
<i>F. subglutinans</i> (M3869)	GGTGGCAAGG	CCCCTCGCAA	GCAGCTCGCT	TCCAAGGCTG	GTAAGTATTC	ACCGCGACTT
<i>F. subglutinans</i> (M3935)	nnnnnnnnnn	nn.....	.....	.....	.....	.....
<i>F. subglutinans</i> (Fst9)	.....	.....	.....	.....	.....	.....
<i>F. subglutinans</i> (Fst10)	.....	.....	.....	.....	.....	.....
<i>F. subglutinans</i> (Fst13)	.....	.....	.....	.....	.....	.....
<i>F. subglutinans</i> (Fst17)	.....	.....	.....	.....	.....	.....
<i>F. subglutinans</i> (Fst22)	.....	.....	.....	.....	.....	.....
<i>F. subglutinans</i> (Fst26)	nnnnnnnnnn	nnn.....	.....	.....	.....	.....
<i>F. subglutinans</i> (Fst40)	nnnnnnnnnn	nn.....	.....	.....	.....	.....
<i>F. subglutinans</i> (Fst51)	.....	.....	.....	.....	.....	.....
<i>F. subglutinans</i> (Fst54)	.....	.....	.....	.....	.....	.....
<i>F. subglutinans</i> (Fst58)	.....	.....	.....	.....	.....	.....
<i>F. subglutinans</i> (Fst69)	.....	.....	.....	.....	.....	.....
<i>F. subglutinans</i> (MRC115)	.....	.....	.....	.....	.....	.....
<i>F. subglutinans</i> (MRC714)	.....	.....	.....	.....	.....	.....
<i>F. subglutinans</i> (MRC756)	.....	.....	.....	.....	.....	.....
<i>F. subglutinans</i> (MRC837)	.....	.....	.....	.....	.....	.....
<i>F. subglutinans</i> (MRC1077)	.....	.....	.....	.....	.....	.....
<i>F. subglutinans</i> (MRC1084)	.....	.....	.....	.....	.....	.....
<i>F. subglutinans</i> (KSU434)	.....	.....	.....T.....	.....	.....	.....
<i>F. subglutinans</i> (KSU507)	.....	.....	.....	.....	.....	.....
<i>F. subglutinans</i> (KSU731)	.....	.....	.....T.....	.....	.....	.....
<i>F. subglutinans</i> (KSU993)	.....	.....	.....	.....	.....	.....
<i>F. subglutinans</i> (KSU1257)	.....	.....	.....	.....	.....	.....
<i>F. subglutinans</i> (KSU1417)	.....	.....	.....	.....	.....	.....
<i>F. subglutinans</i> (KSU2921)	.....	.....	.....	.....	.....	.....
<i>F. subglutinans</i> (KSU3851)	.....	.....	.....	.....	.....	.....
<i>F. subglutinans</i> (MRC6512)	.....	.....	.....	.....	.....C.....	.....
<i>F. subglutinans</i> (MRC6483)	.....	.....	.....	.....	.....C.....	.....

	70	80	90	100	110	120
<i>F. subglutinans</i> (M3869)	GAACTCGACG	CGACACGCGT	CTTGGTCCAT	CAAAAACACC	TTCACTAACT	TCACCACCAA
<i>F. subglutinans</i> (M3935)	.....	.....	.....	.....	.....	.....
<i>F. subglutinans</i> (Fst9)	.....	.....	.....	.....T.....	.....	.....
<i>F. subglutinans</i> (Fst10)	.....	.....	.....	.....	.....	.....
<i>F. subglutinans</i> (Fst13)	.....	.....	.....	.....	.....	.....
<i>F. subglutinans</i> (Fst17)	.....	.....	.....	.....	.....	.....
<i>F. subglutinans</i> (Fst22)	.....	.....	.....	.....	.....	.....
<i>F. subglutinans</i> (Fst26)	.....	.....	.....	.....T.....	.....	.....
<i>F. subglutinans</i> (Fst40)	.....	.....	.....	.....	.....	.....
<i>F. subglutinans</i> (Fst51)	.....	.....	.....	.....	.....	.....
<i>F. subglutinans</i> (Fst54)	.....	.....	.....	.....	.....	.....
<i>F. subglutinans</i> (Fst58)	.....	.....	.....	.....	.....	.....
<i>F. subglutinans</i> (Fst69)	.....	.....	.....	.....	.....	.....
<i>F. subglutinans</i> (MRC115)	.....	.....	.....	.....	.....	.....
<i>F. subglutinans</i> (MRC714)	.....	.....	.....	.....	.....	.....
<i>F. subglutinans</i> (MRC756)	.....	.....	.....	.....	.....	.....
<i>F. subglutinans</i> (MRC837)	.....	.....	.....	.....	.....	.....
<i>F. subglutinans</i> (MRC1077)	.....	.....	.....	.....	.....	.....
<i>F. subglutinans</i> (MRC1084)	.....	.....	.....	.....	.....	.....
<i>F. subglutinans</i> (KSU434)	.....	.....	.....	.....	.....	.....
<i>F. subglutinans</i> (KSU507)	.....	.....	.....	.....	.....	.....
<i>F. subglutinans</i> (KSU731)	.....	.....	.....	.....	.....	.....
<i>F. subglutinans</i> (KSU993)	.....	.....	.....	.....	.....	.....
<i>F. subglutinans</i> (KSU1257)	.....	.....	.....	.....	.....	.....
<i>F. subglutinans</i> (KSU1417)	.....	.....	.....	.....	.....	.....
<i>F. subglutinans</i> (KSU2921)	.....	.....	.....	.....	.....	.....
<i>F. subglutinans</i> (KSU3851)	.....	.....	.....	.....	.....	.....
<i>F. subglutinans</i> (MRC6512)	.....	.....	.....	.....	.....	.....
<i>F. subglutinans</i> (MRC6483)	.....	.....	.....	.....	.....	.....



	130	140	150	160	170	180
<i>F. subglutinans</i> (M3869)	CAGCCCGCAA	GTCCGCCCCA	TCCACCGGAG	GTGTCAAGAA	GCCTCACCGC	TACAAGCCTG
<i>F. subglutinans</i> (M3935)	.....	.....	.....	.....	.....	.....
<i>F. subglutinans</i> (Fst9)	.....	.....	.....	.....	.....	.....
<i>F. subglutinans</i> (Fst10)	.....	.....	.....	.....	.....	.....
<i>F. subglutinans</i> (Fst13)	.....	.....	.....	.....	.....	.....
<i>F. subglutinans</i> (Fst17)	.....	.....	.....	.....	.....	.....
<i>F. subglutinans</i> (Fst22)	.....	.....	.....	.....	.....	.....
<i>F. subglutinans</i> (Fst26)	.....	.....	.....	.....	.....	.....
<i>F. subglutinans</i> (Fst40)	.....	.....	.....	.....	.....	.....
<i>F. subglutinans</i> (Fst51)	.....	.....	.....	.....	.....	.....
<i>F. subglutinans</i> (Fst54)	.....	.....	.....	.....	.....	.....
<i>F. subglutinans</i> (Fst58)	.....	.....	.....	.....	.....	.....
<i>F. subglutinans</i> (Fst69)	.....	.....	.....	.....	.....	.....
<i>F. subglutinans</i> (MRC115)	.....	.....	.....	.....	.....	.....
<i>F. subglutinans</i> (MRC714)	.....	.....	.....	.....	.....	.....
<i>F. subglutinans</i> (MRC756)	.....	.....	.....	.....	.....	.....
<i>F. subglutinans</i> (MRC837)	.....	.....	.....	.....	.....	.....
<i>F. subglutinans</i> (MRC1077)	.....	.....	.....	.....	.....	.....
<i>F. subglutinans</i> (MRC1084)	.....	.....	.....	.....	.....	.....
<i>F. subglutinans</i> (KSU434)	.....	.....	.....	.....	.....	.....
<i>F. subglutinans</i> (KSU507)	.....	.....	.....	.....	.....	.....
<i>F. subglutinans</i> (KSU731)	.....	.....	.....	.....	.....	.....
<i>F. subglutinans</i> (KSU993)	.....	.....	.....	.....	.....	.....
<i>F. subglutinans</i> (KSU1257)	.....	.....	.....	.....	.....	.....
<i>F. subglutinans</i> (KSU1417)	.....	.....	.....	.....	.....	.....
<i>F. subglutinans</i> (KSU2921)	.....	.....	.....	.....	.....	.....
<i>F. subglutinans</i> (KSU3851)	.....	.....	.....	.....	.....	.....
<i>F. subglutinans</i> (MRC6512)	.....	.....	.....	.....	.....	.....
<i>F. subglutinans</i> (MRC6483)	.....	.....	.....	.....	.....	.....

	190	200	210	220	230	240
<i>F. subglutinans</i> (M3869)	GTACCGTTGC	TCTCCGTGAG	ATTTCGACGAT	ACCAGAAGTC	GACCGAGCTC	CTCATCCGAA
<i>F. subglutinans</i> (M3935)	.....	.....	.....	.....	.....	.....
<i>F. subglutinans</i> (Fst9)	.....	.....	.....	.....	.....	.....
<i>F. subglutinans</i> (Fst10)	.....	.....	.....	.....	.....	.....
<i>F. subglutinans</i> (Fst13)	.....	.....	.....	.....	.....	.....
<i>F. subglutinans</i> (Fst17)	.....	.....	.....	.....	.....	.....
<i>F. subglutinans</i> (Fst22)	.....	.....	.....	.....	.....	.....
<i>F. subglutinans</i> (Fst26)	.....	.....	.....	.....	.....	.....
<i>F. subglutinans</i> (Fst40)	.....	.....	.....	.....	.....	.....
<i>F. subglutinans</i> (Fst51)	.....	.....	.....	.....	.....	.....
<i>F. subglutinans</i> (Fst54)	.....	.....	.....	.....	.....	.....
<i>F. subglutinans</i> (Fst58)	.....	.....	.....	.....	.....	.....
<i>F. subglutinans</i> (Fst69)	.....	.....	.....	.....	.....	.....
<i>F. subglutinans</i> (MRC115)	.....	.....	.....	.....	.....	.....
<i>F. subglutinans</i> (MRC714)	.....	.....	.....	.....	.....	.....
<i>F. subglutinans</i> (MRC756)	.....	.....	.....	.....	.....	.....
<i>F. subglutinans</i> (MRC837)	.....	.....	.....	.....	.....	.....
<i>F. subglutinans</i> (MRC1077)	.....	.....	.....	.....	.....	.....
<i>F. subglutinans</i> (MRC1084)	.....	.....	.....	.....	.....	.....
<i>F. subglutinans</i> (KSU434)	.....	.....	.....	.....	.....	.....
<i>F. subglutinans</i> (KSU507)	.....	.....	.....	.....	.....	.....
<i>F. subglutinans</i> (KSU731)	.....	.....	.....	.....	.....	.....
<i>F. subglutinans</i> (KSU993)	.....	.....	.....	.....	.....	.....
<i>F. subglutinans</i> (KSU1257)	.....	.....	.....	.....	.....	.....
<i>F. subglutinans</i> (KSU1417)	.....	.....	.....	.....	.....	.....
<i>F. subglutinans</i> (KSU2921)	.....	.....	.....	.....	.....	.....
<i>F. subglutinans</i> (KSU3851)	.....	.....	.....	.....	.....	.....
<i>F. subglutinans</i> (MRC6512)	.....	.....	.....	.....	.....	.....
<i>F. subglutinans</i> (MRC6483)	.....	.....	.....	.....	.....	.....



	250	260	270	280	290	300
<i>F. subglutinans</i> (M3869)	AGCTCCCCTT	CCAGCGCCTG	GTAAGCACCA	CCTGCTACAT	CAACCGCAGC	CTGACACATA
<i>F. subglutinans</i> (M3935)	.....	.....	.....	.....	.....	.....
<i>F. subglutinans</i> (Fst9)	.....	.....	.....	.....C.....	.....	.....
<i>F. subglutinans</i> (Fst10)	.....	.....	.....	.....	.....A.....	.....
<i>F. subglutinans</i> (Fst13)	.....	.....	.....	.....	.....A.....	.....
<i>F. subglutinans</i> (Fst17)	.....	.....	.....	.....	.....A.....	.....
<i>F. subglutinans</i> (Fst22)	.....	.....	.....	.....	.....A.....	.....
<i>F. subglutinans</i> (Fst26)	.....	.....	.....	.....C.....	.....	.....
<i>F. subglutinans</i> (Fst40)	.....	.....	.....	.....	.....A.....	.....
<i>F. subglutinans</i> (Fst51)	.....	.....	.....	.....	.....	.....
<i>F. subglutinans</i> (Fst54)	.....	.....	.....	.....	.....	.....
<i>F. subglutinans</i> (Fst58)	.....	.....	.....	.....	.....	.....
<i>F. subglutinans</i> (Fst69)	.....	.....	.....	.....	.....	.....
<i>F. subglutinans</i> (MRC115)	.....	.....	.....	.....	.....A.....	.....
<i>F. subglutinans</i> (MRC714)	.....	.....	.....	.....	.....A.....	.....
<i>F. subglutinans</i> (MRC756)	.....	.....	.....	.....	.....	.....
<i>F. subglutinans</i> (MRC837)	.....	.....	.....	.....	.....	.....
<i>F. subglutinans</i> (MRC1077)	.....	.....	.....	.....	.....	.....
<i>F. subglutinans</i> (MRC1084)	.....	.....	.....	.....	.....	.....
<i>F. subglutinans</i> (KSU434)	.....	.....	.....	.....	.....A.....	.....
<i>F. subglutinans</i> (KSU507)	.....	.....	.....	.....	.....A.....	.....
<i>F. subglutinans</i> (KSU731)	.....	.....	.....	.....	.....A.....	.....
<i>F. subglutinans</i> (KSU993)	.....	.....	.....	.....	.....A.....	.....
<i>F. subglutinans</i> (KSU1257)	.....	.....	.....	.....	.....A.....	.....
<i>F. subglutinans</i> (KSU1417)	.....	.....	.....	.....	.....A.....	.....
<i>F. subglutinans</i> (KSU2921)	.....	.....	.....	.....	.....A.....	.....
<i>F. subglutinans</i> (KSU3851)	.....	.....	.....	.....	.....A.....	.....
<i>F. subglutinans</i> (MRC6512)	.....	.....	.....	.....	.....A.....	.....
<i>F. subglutinans</i> (MRC6483)	.....	.....	.....	.....	.....A.....	.....

	310	320	330	340	350	360
<i>F. subglutinans</i> (M3869)	CTAACATTG	ACAAACAGGT	CCGCGAGATT	GCCCAGGACT	TCAAGTCTGA	CCTCCGCTTC
<i>F. subglutinans</i> (M3935)	.....	.....	.....	.....	.....	.....
<i>F. subglutinans</i> (Fst9)	.....	.....	.....	.....	.....	.....
<i>F. subglutinans</i> (Fst10)	.....	.....	.....	.....	.....	.....T.....
<i>F. subglutinans</i> (Fst13)	.....	.....	.....	.....	.....	.....T.....
<i>F. subglutinans</i> (Fst17)	.....	.....	.....	.....	.....	.....T.....
<i>F. subglutinans</i> (Fst22)	.....	.....	.....	.....	.....	.....T.....
<i>F. subglutinans</i> (Fst26)	.....	.....	.....	.....	.....	.....
<i>F. subglutinans</i> (Fst40)	.....	.....	.....	.....	.....	.....T.....
<i>F. subglutinans</i> (Fst51)	.....	.....	.....	.....	.....	.....
<i>F. subglutinans</i> (Fst54)	.....	.....	.....	.....	.....	.....
<i>F. subglutinans</i> (Fst58)	.....	.....	.....	.....	.....	.....
<i>F. subglutinans</i> (Fst69)	.....	.....	.....	.....	.....	.....
<i>F. subglutinans</i> (MRC115)	.....	.....	.....	.....	.....	.....T.....
<i>F. subglutinans</i> (MRC714)	.....	.....	.....	.....	.....	.....T.....
<i>F. subglutinans</i> (MRC756)	.....	.....	.....	.....	.....	.....
<i>F. subglutinans</i> (MRC837)	.....	.....	.....	.....	.....	.....
<i>F. subglutinans</i> (MRC1077)	.....	.....	.....	.....	.....	.....
<i>F. subglutinans</i> (MRC1084)	.....	.....	.....	.....	.....	.....
<i>F. subglutinans</i> (KSU434)	.....	.....	.....	.....	.....	.....T.....
<i>F. subglutinans</i> (KSU507)	.....	.....	.....	.....	.....	.....T.....
<i>F. subglutinans</i> (KSU731)	.....	.....	.....	.....	.....	.....T.....
<i>F. subglutinans</i> (KSU993)	.....	.....	.....	.....	.....	.....T.....
<i>F. subglutinans</i> (KSU1257)	.....	.....	.....	.....	.....	.....T.....
<i>F. subglutinans</i> (KSU1417)	.....	.....	.....	.....	.....	.....T.....
<i>F. subglutinans</i> (KSU2921)	.....	.....	.....	.....	.....	.....T.....
<i>F. subglutinans</i> (KSU3851)	.....	.....	.....	.....	.....	.....T.....
<i>F. subglutinans</i> (MRC6512)	.....	.....	.....	.....	.....	.....T.....
<i>F. subglutinans</i> (MRC6483)	.....	.....	.....	.....	.....	.....T.....



	370	380	390	400	410	420
<i>F. subglutinans</i> (M3869)	CAGTCTCCG	CCATCGGTGC	TCTCCAGGAG	TCTGTTGAGT	CCTACCTCGT	CTCCCTCTTT
<i>F. subglutinans</i> (M3935)	.....	.....	.....	.....	.....	.....
<i>F. subglutinans</i> (Fst9)	.....	.....	.....	.....	.....	.....
<i>F. subglutinans</i> (Fst10)	.....	.....	.....	.....	.....	.....
<i>F. subglutinans</i> (Fst13)	.....	.....	.....	.....	.....	.....
<i>F. subglutinans</i> (Fst17)	.....	.....	.....	.....	.....	.....
<i>F. subglutinans</i> (Fst22)	.....	.....	.....	.....	.....	.....
<i>F. subglutinans</i> (Fst26)	.....	.....	.....	.....	.....	.....
<i>F. subglutinans</i> (Fst40)	.....	.....	.....	.....	.....	.....
<i>F. subglutinans</i> (Fst51)	.....	.....	.....	.....	.....	.....
<i>F. subglutinans</i> (Fst54)	.....	.....	.....	.....	.....	.....
<i>F. subglutinans</i> (Fst58)	.....	.....	.....	.....	.....	.....
<i>F. subglutinans</i> (Fst69)	.....	.....	.....	.....	.....	.....
<i>F. subglutinans</i> (MRC115)	.....	.....	.....	.....	.....	.....
<i>F. subglutinans</i> (MRC714)	.....	.....	.....	.....	.....	.....
<i>F. subglutinans</i> (MRC756)	.....	.....	.....	.....	.....	.....
<i>F. subglutinans</i> (MRC837)	.....	.....	.....	.....	.....	.....
<i>F. subglutinans</i> (MRC1077)	.....	.....	.....	.....	.....	.....
<i>F. subglutinans</i> (MRC1084)	.....	.....	.....	.....	.....	.....
<i>F. subglutinans</i> (KSU434)	.....	.....	.....	.....	.....	.....
<i>F. subglutinans</i> (KSU507)	.....	.....	.....	.....	.....	.....
<i>F. subglutinans</i> (KSU731)	.....	.....	.....	.....	.....	.....
<i>F. subglutinans</i> (KSU993)	.....	.....	n	.....	.....	.....
<i>F. subglutinans</i> (KSU1257)	.....	.....	.....	.....	.....	.....
<i>F. subglutinans</i> (KSU1417)	.....	.....	.....	.....	.....	.....
<i>F. subglutinans</i> (KSU2921)	.....	.....	.....	.....	.....	.....
<i>F. subglutinans</i> (KSU3851)	.....	.....	.....	.....	.....	.....
<i>F. subglutinans</i> (MRC6512)	.....	.....	.....	.....	.....	.....
<i>F. subglutinans</i> (MRC6483)	.....	.....	.....	.....	.....	.....

	430	440	450	456
<i>F. subglutinans</i> (M3869)	GAGGATACCA	ACCTCTGTGC	CATCCACGCC	AAGCGT
<i>F. subglutinans</i> (M3935)	.....	.....	.....	.....
<i>F. subglutinans</i> (Fst9)	.....C.....	.....	.....	.....
<i>F. subglutinans</i> (Fst10)	.....	.....	.....	.....
<i>F. subglutinans</i> (Fst13)	.....	.....	.....	.....
<i>F. subglutinans</i> (Fst17)	.....	.....	.....	.....
<i>F. subglutinans</i> (Fst22)	.....	.....	.....	.....
<i>F. subglutinans</i> (Fst26)	.....C.....	.....	.....	.....
<i>F. subglutinans</i> (Fst40)	.....	.....	.....	.....
<i>F. subglutinans</i> (Fst51)	.....	.....	.....	.....
<i>F. subglutinans</i> (Fst54)	.....	.....	.....	.....
<i>F. subglutinans</i> (Fst58)	.....	.....	.....	.....
<i>F. subglutinans</i> (Fst69)	.....	.....	.....	.....
<i>F. subglutinans</i> (MRC115)	.....	.....	.....	.....
<i>F. subglutinans</i> (MRC714)	.....	.....	.....	.....
<i>F. subglutinans</i> (MRC756)	.....	.....	.....	.....
<i>F. subglutinans</i> (MRC837)	.....	.....	.....	.....
<i>F. subglutinans</i> (MRC1077)	.....	.....	.....	.....
<i>F. subglutinans</i> (MRC1084)	.....	.....	.....	.....
<i>F. subglutinans</i> (KSU434)	.....	.....	.....	.....
<i>F. subglutinans</i> (KSU507)	.....	.....	.....	.....
<i>F. subglutinans</i> (KSU731)	.....	.....	.....	.....
<i>F. subglutinans</i> (KSU993)	.....	.....	.....	.....
<i>F. subglutinans</i> (KSU1257)	.....	.....	.....	.....
<i>F. subglutinans</i> (KSU1417)	.....	.....	.....	.....
<i>F. subglutinans</i> (KSU2921)	.....	.....	.....	.....
<i>F. subglutinans</i> (KSU3851)	.....	.....	.....	.....
<i>F. subglutinans</i> (MRC6512)	.....	.....	.....	.....
<i>F. subglutinans</i> (MRC6483)	.....	.....	.....	.....



**HB-9**

	10	20	30	40	50	60
<i>F. subglutinans</i> (M3869)	TTCAATACCC	CTCGCCTAGA	AACTCTCCAA	GCACATCGCG	TCTATACGCA	AGCTCCTTCT
<i>F. subglutinans</i> (M3935)	.....	.....	.....	.....	.....	.....
<i>F. subglutinans</i> (Fst9)	.....	.....	.....	.....	.....	.....
<i>F. subglutinans</i> (Fst10)	.....	.....	.....	.....	.....	.....
<i>F. subglutinans</i> (Fst13)	.....	.....	.....	.....	.....	.....
<i>F. subglutinans</i> (Fst17)	.....	.....	.....	.....	.....	.....
<i>F. subglutinans</i> (Fst22)	.....	.....	.....	.....	.....	.....
<i>F. subglutinans</i> (Fst26)	.....	.....	.....	.....	.....	.....
<i>F. subglutinans</i> (Fst40)	.....	.....	.....	.....	.....	.....
<i>F. subglutinans</i> (Fst51)	.....	.....	.....	.....	.....	.....
<i>F. subglutinans</i> (Fst54)	.....	.....	.....	.....	.....	.....
<i>F. subglutinans</i> (Fst58)	.....	.....	.....	.....	.....	.....
<i>F. subglutinans</i> (Fst69)	.....	.....	.....	.....	.....	.....
<i>F. subglutinans</i> (MRC115)	.....	.....	.....	.....	.....	.....
<i>F. subglutinans</i> (MRC714)	.....	.....	.....	.....	.....	.....
<i>F. subglutinans</i> (MRC756)	.....	.....	.....	.....	.....	.....
<i>F. subglutinans</i> (MRC837)	.....	.....	.....	.....	.....	.....
<i>F. subglutinans</i> (MRC1077)	.....	.....	.....	.....	.....	.....
<i>F. subglutinans</i> (MRC1084)	.....	.....	.....	.....	.....	.....
<i>F. subglutinans</i> (KSU434)	.....	.....	.....	.....	.....	.....
<i>F. subglutinans</i> (KSU507)	.....	.....	.....	.....	.....	.....
<i>F. subglutinans</i> (KSU731)	.....	.....	.....	.....	.....	.....
<i>F. subglutinans</i> (KSU993)	.....	.....	.....	.....	.....	.....
<i>F. subglutinans</i> (KSU1257)	.....	.....	.....	.....	.....	.....
<i>F. subglutinans</i> (KSU1417)	.....	.....	.....	.....	.....	.....
<i>F. subglutinans</i> (KSU2921)	nnn.....	.....	.....	.....	.....	.....
<i>F. subglutinans</i> (KSU3851)	.....	.....	.....	.....	.....	.....
<i>F. subglutinans</i> (MRC6512)	.....	.....	.....	.....	.....	.....
<i>F. subglutinans</i> (MRC6483)	.....	.....	.....	.....	.....	.....

	70	80	90	100	110	120
<i>F. subglutinans</i> (M3869)	TCTCTTTTGA	CCACAGCCCTC	GAGAACATTA	CATGAATCAA	CACTTCTCAG	GTGAGCTACG
<i>F. subglutinans</i> (M3935)	.....	.....	.....	.....	.....	.....
<i>F. subglutinans</i> (Fst9)	.....	.....	.....	.....	.....	.....
<i>F. subglutinans</i> (Fst10)	.....	.....	.....	.....	T.....	.....
<i>F. subglutinans</i> (Fst13)	.....	.....	.....	.....	T.....	.....
<i>F. subglutinans</i> (Fst17)	.....	.....	.....	.....	T.....	.....
<i>F. subglutinans</i> (Fst22)	.....	.....	.....	.....	T.....	.....
<i>F. subglutinans</i> (Fst26)	.....	.....	.....	.....	.....	.....
<i>F. subglutinans</i> (Fst40)	.....	.....	.....	.....	T.....	.....
<i>F. subglutinans</i> (Fst51)	.....	.....	.....	.....	.....	.....
<i>F. subglutinans</i> (Fst54)	.....	.....	.....	.....	.....	.....
<i>F. subglutinans</i> (Fst58)	.....	.....	.....	.....	.....	.....
<i>F. subglutinans</i> (Fst69)	.....	.....	.....	.....	.....	.....
<i>F. subglutinans</i> (MRC115)	.....	.....	.....	.....	T.....	.....
<i>F. subglutinans</i> (MRC714)	.....	.....	.....	.....	T.....	.....
<i>F. subglutinans</i> (MRC756)	.....	.....	.....	.....	.....	.....
<i>F. subglutinans</i> (MRC837)	.....	.....	.....	.....	.....	.....
<i>F. subglutinans</i> (MRC1077)	.....	.....	.....	.....	.....	.....
<i>F. subglutinans</i> (MRC1084)	.....	.....	.....	.....	.....	.....
<i>F. subglutinans</i> (KSU434)	.....	.....	.....	.....	T.....	.....
<i>F. subglutinans</i> (KSU507)	.....	.....	.....	.....	T.....	.....
<i>F. subglutinans</i> (KSU731)	.....	.....	.....	.....	T.....	.....
<i>F. subglutinans</i> (KSU993)	.....	.....	.....	.....	T.....	.....
<i>F. subglutinans</i> (KSU1257)	.....	.....	.....	.....	T.....	.....
<i>F. subglutinans</i> (KSU1417)	.....	.....	.....	.....	T.....	.....
<i>F. subglutinans</i> (KSU2921)	.....	.....	.....	.....	T.....	.....
<i>F. subglutinans</i> (KSU3851)	.....	.....	.....	.....	T.....	.....
<i>F. subglutinans</i> (MRC6512)	.....	.....	.....	.....	T.....	.....
<i>F. subglutinans</i> (MRC6483)	.....	.....	.....	.....	T.....	.....





	130	140	150	160	170	180
<i>F. subglutinans</i> (M3869)	CTATACTAGA	CAACACCTGG	ACAGTAAACA	AGACAAAAAA	CTCCTGTAGG	TCCGTTCCCA
<i>F. subglutinans</i> (M3935)	.....	.....	.....	.....	.....	.....
<i>F. subglutinans</i> (Fst9)	.....	.....	.....	.....	.....	.....
<i>F. subglutinans</i> (Fst10)	.....	.....	.....	.....	.....	.....
<i>F. subglutinans</i> (Fst13)	.....	.....	.....	.....	.....	.....
<i>F. subglutinans</i> (Fst17)	.....	.....	.....	.....	.....	.....
<i>F. subglutinans</i> (Fst22)	.....	.....	.....	.....	.....	.....
<i>F. subglutinans</i> (Fst26)	.....	.....	.....	.....	.....	.....
<i>F. subglutinans</i> (Fst40)	.....	.....	.....	.....	.....	.....
<i>F. subglutinans</i> (Fst51)	.....	.....	.....	.....	.....	.....
<i>F. subglutinans</i> (Fst54)	.....	.....	.....	.....	.....	.....
<i>F. subglutinans</i> (Fst58)	.....	.....	.....	.....	.....	.....
<i>F. subglutinans</i> (Fst69)	.....	.....	.....	.....	.....	.....
<i>F. subglutinans</i> (MRC115)	.....	.....	.....	.....	.....	.....
<i>F. subglutinans</i> (MRC714)	.....	.....	.....	.....	.....	.....
<i>F. subglutinans</i> (MRC756)	.....	.....	.....	.....	.....	.....
<i>F. subglutinans</i> (MRC837)	.....	.....	.....	.....	.....	.....
<i>F. subglutinans</i> (MRC1077)	.....	.....	.....	.....	.....	.....
<i>F. subglutinans</i> (MRC1084)	.....	.....	.....	.....	.....	.....
<i>F. subglutinans</i> (KSU434)	.....	.....	.....	.....	.....	.....
<i>F. subglutinans</i> (KSU507)	.....	.....	.....	.....	.....	.....
<i>F. subglutinans</i> (KSU731)	.....	.....	.....	.....	.....	.....
<i>F. subglutinans</i> (KSU993)	.....	.....	.....	.....	.....	.....
<i>F. subglutinans</i> (KSU1257)	.....	.....	.....	.....	.....	.....
<i>F. subglutinans</i> (KSU1417)	.....	.....	.....	.....	.....	.....
<i>F. subglutinans</i> (KSU2921)	.....	.....	.....	.....	.....	.....
<i>F. subglutinans</i> (KSU3851)	.....	.....	.....	.....	.....	.....
<i>F. subglutinans</i> (MRC6512)	.....	.....	.....	.....	.....	.....
<i>F. subglutinans</i> (MRC6483)	.....	.....	.....	.....	.....	.....

	190	200	210	220	230	240
<i>F. subglutinans</i> (M3869)	GCTTCCCATG	CGCTGATCCC	ATTCAGAGAG	GTCTGCTCAA	ACAAAATAAT	GTGTTGGCTA
<i>F. subglutinans</i> (M3935)	.....	.....	.....	.....	.....	.....
<i>F. subglutinans</i> (Fst9)	.....	.....	.....	.....	.....	.....
<i>F. subglutinans</i> (Fst10)	.....	.....	..G.	.....	.....	.....
<i>F. subglutinans</i> (Fst13)	.....	.....	..G.	.....	.....	.....
<i>F. subglutinans</i> (Fst17)	.....	.....	..G.	.....	.....nnnn	nnnnnnnnnn
<i>F. subglutinans</i> (Fst22)	.....	.....	..G.	.....	.....	.....
<i>F. subglutinans</i> (Fst26)	.....	.....	.....	.....	.....	.....
<i>F. subglutinans</i> (Fst40)	.....	.....	..G.	.....	.....	.....
<i>F. subglutinans</i> (Fst51)	.....	.....	.....	.....	.....	.....
<i>F. subglutinans</i> (Fst54)	.....	.....	.....	.....	.....	.....
<i>F. subglutinans</i> (Fst58)	.....	.....	.....	.....	.....	.....
<i>F. subglutinans</i> (Fst69)	.....	.....	.....	.....	.....	.....
<i>F. subglutinans</i> (MRC115)	.....	.....	..G.	.....	.....	.....
<i>F. subglutinans</i> (MRC714)	.....	.....	..G.	.....	.....	.....
<i>F. subglutinans</i> (MRC756)	.....	.....	.....	.....	.....	.....
<i>F. subglutinans</i> (MRC837)	.....	.....	.....	.....	.....	.....
<i>F. subglutinans</i> (MRC1077)	.....	.....	.....	.....	.....	.....nnnnnnn
<i>F. subglutinans</i> (MRC1084)	.....	.....	.....	.....	.....	.....
<i>F. subglutinans</i> (KSU434)	.....	.....	..G.	.....	.....	.....
<i>F. subglutinans</i> (KSU507)	.....	.....	..G.	.....	.....	.....
<i>F. subglutinans</i> (KSU731)	.....	.....	..G.	.....	.....	.....
<i>F. subglutinans</i> (KSU993)	.....	.....	..G.	.....	.....	.....
<i>F. subglutinans</i> (KSU1257)	.....	.....	..G.	.....	.....	.....
<i>F. subglutinans</i> (KSU1417)	.....	.....	..G.	.....	.....	.....
<i>F. subglutinans</i> (KSU2921)	.....	.....	..G.	.....	.....	.....
<i>F. subglutinans</i> (KSU3851)	.....	.....	..G.	.....	.....	.....
<i>F. subglutinans</i> (MRC6512)	.....	.....	..G.	.....	.....	.....
<i>F. subglutinans</i> (MRC6483)	.....	.....	..G.	.....	.....	.....



250

<i>F. subglutinans</i> (M3869)	GAATGCAGTG
<i>F. subglutinans</i> (M3935)	.....
<i>F. subglutinans</i> (Fst9)	.....
<i>F. subglutinans</i> (Fst10)	.....
<i>F. subglutinans</i> (Fst13)	.....
<i>F. subglutinans</i> (Fst17)	nnnnnnnnnn
<i>F. subglutinans</i> (Fst22)	.....
<i>F. subglutinans</i> (Fst26)	.....
<i>F. subglutinans</i> (Fst40)	.....
<i>F. subglutinans</i> (Fst51)	.....
<i>F. subglutinans</i> (Fst54)	.....
<i>F. subglutinans</i> (Fst58)	.....
<i>F. subglutinans</i> (Fst69)	.....
<i>F. subglutinans</i> (MRC115)	.....
<i>F. subglutinans</i> (MRC714)	.....
<i>F. subglutinans</i> (MRC756)	.....
<i>F. subglutinans</i> (MRC837)	.....
<i>F. subglutinans</i> (MRC1077)	nnnnnnnnnn
<i>F. subglutinans</i> (MRC1084)	.....
<i>F. subglutinans</i> (KSU434)	.....
<i>F. subglutinans</i> (KSU507)	.....
<i>F. subglutinans</i> (KSU731)	.....
<i>F. subglutinans</i> (KSU993)	.....
<i>F. subglutinans</i> (KSU1257)	.....
<i>F. subglutinans</i> (KSU1417)	.....
<i>F. subglutinans</i> (KSU2921)	.....
<i>F. subglutinans</i> (KSU3851)	.....
<i>F. subglutinans</i> (MRC6512)	.....
<i>F. subglutinans</i> (MRC6483)	.....



**HB-14**

	10	20	30	40	50	60
<i>F. subglutinans</i> (M3869)	CCATGAGAGG	AAACCTCCTC	CTTCGATTTC	ACGTGCCAGC	GGAATTACCC	CAAGAGGACA
<i>F. subglutinans</i> (M3935)	.....	.....	.....	.....	.....	.....
<i>F. subglutinans</i> (Fst9)	.....	.....	.....	.....	.....	.....
<i>F. subglutinans</i> (Fst10)	.....	.....	.....	.....	.....	.....
<i>F. subglutinans</i> (Fst13)	.....	.....	.....	.....	.....	.....
<i>F. subglutinans</i> (Fst17)	.....	.....	.....	.....	.....	.....
<i>F. subglutinans</i> (Fst22)	.....	.....	.....	.....	.....	.....
<i>F. subglutinans</i> (Fst26)	.....	.....	.....	.....	.....	.....
<i>F. subglutinans</i> (Fst40)	.....	.....	.....	.....	.....	.....
<i>F. subglutinans</i> (Fst51)	.....	.....	.....	.....	.....	.....
<i>F. subglutinans</i> (Fst54)	.....	.....	.....	.....	.....	.....
<i>F. subglutinans</i> (Fst58)	.....	.....	.....	.....	.....	.....
<i>F. subglutinans</i> (Fst69)	.....	.....	.....	.....	.....	.....
<i>F. subglutinans</i> (MRC115)	.....	.....	.....	.....	.....	.....
<i>F. subglutinans</i> (MRC714)	.....	.....	.....	.....	.....	.....
<i>F. subglutinans</i> (MRC756)	.....	.....	.....	.....	.....	.....
<i>F. subglutinans</i> (MRC837)	.....	.....	.....	.....	.....	.....
<i>F. subglutinans</i> (MRC1077)	.....	.....	.....	.....	.....	.....
<i>F. subglutinans</i> (MRC1084)	.....	.....	.....	.....	.....	.....
<i>F. subglutinans</i> (KSU434)	.....	.....	.....	.....	.....	.....
<i>F. subglutinans</i> (KSU507)	.....	.....	.....	.....	.....	.....
<i>F. subglutinans</i> (KSU731)	.....	.....	.....	.....	.....	.....
<i>F. subglutinans</i> (KSU993)	nnnnnnnnnn	nnnnnnnnnn	nnnnnnnnnn	nn.....	.....	.....
<i>F. subglutinans</i> (KSU1257)	.....	.....	.....	.....	.....	.....
<i>F. subglutinans</i> (KSU1417)	.....	.....	.....	.....	.....	.....
<i>F. subglutinans</i> (KSU2921)	.....	.....	.....	.....	.....	.....
<i>F. subglutinans</i> (KSU3851)	.....	.....	.....	.....	.....	.....
<i>F. subglutinans</i> (MRC6512)	.....	.....	.....	.....	.....	.....
<i>F. subglutinans</i> (MRC6483)	.....	.....	.....	.....	.....	.....

	70	80	90	100	110	120
<i>F. subglutinans</i> (M3869)	AGGAGCGGGA	ACTTGATGTG	AGGCACGAAA	TAAGCTAATC	CAACAGATCC	AATGGGAGCT
<i>F. subglutinans</i> (M3935)	.....	.....	.....	.....	.....	.....
<i>F. subglutinans</i> (Fst9)	.....	.....	.....	.....	.....	.....
<i>F. subglutinans</i> (Fst10)	.....	.....	.....	.....C	.....	.....
<i>F. subglutinans</i> (Fst13)	.....	.....	.....	.....C	.....	.....
<i>F. subglutinans</i> (Fst17)	.....	.....	.....	.....C	.....	.....
<i>F. subglutinans</i> (Fst22)	.....	.....	.....	.....C	.....	.....
<i>F. subglutinans</i> (Fst26)	.....	.....	.....	.....	.....	.....
<i>F. subglutinans</i> (Fst40)	.....	.....	.....	.....C	.....	.....
<i>F. subglutinans</i> (Fst51)	.....	.....	.....	.....	.....	.....
<i>F. subglutinans</i> (Fst54)	.....	.....	.....	.....	.....	.....
<i>F. subglutinans</i> (Fst58)	.....	.....	.....	.....	.....	.....
<i>F. subglutinans</i> (Fst69)	.....	.....	.....	.....	.....	.....
<i>F. subglutinans</i> (MRC115)	.....	.....	.....	.....C	.....	.....
<i>F. subglutinans</i> (MRC714)	.....	.....	.....	.....C	.....	.....
<i>F. subglutinans</i> (MRC756)	.....	.....	.....	.....	.....	.....
<i>F. subglutinans</i> (MRC837)	.....	.....	.....	.....	.....	.....
<i>F. subglutinans</i> (MRC1077)	.....	.....	.....	.....	.....	.....
<i>F. subglutinans</i> (MRC1084)	.....	.....	.....	.....	.....	.....
<i>F. subglutinans</i> (KSU434)	.....	.....	.....	.....C	.....	.....
<i>F. subglutinans</i> (KSU507)	.....	.....	.....	.....C	.....	.....
<i>F. subglutinans</i> (KSU731)	.....	.....	.....	.....C	.....	.....
<i>F. subglutinans</i> (KSU993)	.....	.....	.....	.....C	.....	.....
<i>F. subglutinans</i> (KSU1257)	.....	.....	.....	.....C	.....	.....
<i>F. subglutinans</i> (KSU1417)	.....	.....	.....	.....C	.....	.....
<i>F. subglutinans</i> (KSU2921)	.....	.....	.....	.....C	.....	.....
<i>F. subglutinans</i> (KSU3851)	.....	.....	.....	.....C	.....	.....
<i>F. subglutinans</i> (MRC6512)	.....	.....	.....	.....C	.....	.....
<i>F. subglutinans</i> (MRC6483)	.....	.....	.....	.....C	.....	.....



	130	140	150	160	170	180
<i>F. subglutinans</i> (M3869)	CTCAAAGCGA	CACGATGCAT	GGAATAGAAC	AAGCACAGAC	CACTCATTCC	ACGCCCGATG
<i>F. subglutinans</i> (M3935)	.....	.....	.....	.....	.....	.....
<i>F. subglutinans</i> (Fst9)	.....	.....	.....	.....	.....	.....
<i>F. subglutinans</i> (Fst10)	.....	.....	.....	.....	.....	.....
<i>F. subglutinans</i> (Fst13)	.....	.....	.....	.....	.....	.....
<i>F. subglutinans</i> (Fst17)	.....	.....	.....	.....	.....	.....
<i>F. subglutinans</i> (Fst22)	.....	.....	.....	.....	.....	.....
<i>F. subglutinans</i> (Fst26)	.....	.....	.....	.....	.....	.....
<i>F. subglutinans</i> (Fst40)	.....	.....	.....	.....	.....	.....
<i>F. subglutinans</i> (Fst51)	.....	.....	.....	.....	.....	.....
<i>F. subglutinans</i> (Fst54)	.....	.....	.....	.....	.....	.....
<i>F. subglutinans</i> (Fst58)	.....	.....	.....	.....	.....	.....
<i>F. subglutinans</i> (Fst69)	.....	.....	.....	.....	.....	.....
<i>F. subglutinans</i> (MRC115)	.....	.....	.....	.....	.....	.....
<i>F. subglutinans</i> (MRC714)	.....	.....	.....	.....	.....	.....
<i>F. subglutinans</i> (MRC756)	.....	.....	.....	.....	.....	.....
<i>F. subglutinans</i> (MRC837)	.....	.....	.....	.....	.....	.....
<i>F. subglutinans</i> (MRC1077)	.....	.....	.....	.....	.....	.....
<i>F. subglutinans</i> (MRC1084)	.....	.....	.....	.....	.....	.....
<i>F. subglutinans</i> (KSU434)	.....	.....	.....	.....	.....	.....
<i>F. subglutinans</i> (KSU507)	.....	.....	.....	.....	.....	.....
<i>F. subglutinans</i> (KSU731)	.....	.....	.....	.....	.....	.....
<i>F. subglutinans</i> (KSU993)	.....	.....	.....	.....	.....	.....
<i>F. subglutinans</i> (KSU1257)	.....	.....	.....	.....	.....	.....
<i>F. subglutinans</i> (KSU1417)	.....	.....	.....	.....	.....	.....
<i>F. subglutinans</i> (KSU2921)	.....	.....	.....	.....	.....	.....
<i>F. subglutinans</i> (KSU3851)	.....	.....	.....	.....	.....	.....
<i>F. subglutinans</i> (MRC6512)	.....	.....	.....	.....	.....	.....
<i>F. subglutinans</i> (MRC6483)	.....	.....	.....	.....	.....	.....

	190	200	210	220	230	235
<i>F. subglutinans</i> (M3869)	CCGGATCCCG	GTGTAAGCGC	TCTCGAGAAG	ACAGTGAAAG	TGAGGTTAA-	--AGG
<i>F. subglutinans</i> (M3935)	.....	.....	.....	.....	.....	.....
<i>F. subglutinans</i> (Fst9)	.....	.....	.....	.....	.....	.....
<i>F. subglutinans</i> (Fst10)	.....	.....	.....	.....	.....T	AA...
<i>F. subglutinans</i> (Fst13)	.....	.....	.....	.....	.....T	AA...
<i>F. subglutinans</i> (Fst17)	.....	.....	.....	.....	.....T	AA...
<i>F. subglutinans</i> (Fst22)	.....	.....	.....	.....	.....T	AA...
<i>F. subglutinans</i> (Fst26)	.....	.....	.....	.....	.....	.....
<i>F. subglutinans</i> (Fst40)	.....	.....	.....	.....	.....T	AA...
<i>F. subglutinans</i> (Fst51)	.....	.....	.....	.....	.....	.....
<i>F. subglutinans</i> (Fst54)	.....	.....	.....	.....	.....	.....
<i>F. subglutinans</i> (Fst58)	.....	.....	.....	.....	.....	.....
<i>F. subglutinans</i> (Fst69)	.....	.....	.....	.....	.....	.....
<i>F. subglutinans</i> (MRC115)	.....	.....	.....	.....	.....T	AA...
<i>F. subglutinans</i> (MRC714)	.....	.....	.....	.....	.....T	AA...
<i>F. subglutinans</i> (MRC756)	.....	.....	.....	.....	.....	.....
<i>F. subglutinans</i> (MRC837)	.....	.....	.....	.....	.....	.....
<i>F. subglutinans</i> (MRC1077)	.....	.....	.....	.....	.....	.....
<i>F. subglutinans</i> (MRC1084)	.....	.....	.....	.....	.....	.....
<i>F. subglutinans</i> (KSU434)	.....	.....	.....	.....	.....T	AA...
<i>F. subglutinans</i> (KSU507)	.....	.....	.....	.....	.....T	AA...
<i>F. subglutinans</i> (KSU731)	.....	.....	.....	.....	.....T	AA...
<i>F. subglutinans</i> (KSU993)	.....	.....	.....	.....	.....T	AA...
<i>F. subglutinans</i> (KSU1257)	.....	.....	.....	.....	.....T	AA...
<i>F. subglutinans</i> (KSU1417)	.....	.....	.....	.....	.....T	AA...
<i>F. subglutinans</i> (KSU2921)	.....	.....	.....	.....	.....T	AA...
<i>F. subglutinans</i> (KSU3851)	.....	.....	.....	.....	.....T	AA...
<i>F. subglutinans</i> (MRC6512)	.....	.....	.....	.....	.....T	AA...
<i>F. subglutinans</i> (MRC6483)	.....	.....	.....	.....	.....T	AA...



HB-26

	10	20	30	40	50	60
<i>F. subglutinans</i> (M3869)	TCACAATGGC	TTTCTTGATA	CCTTGAAAGC	TTCGGTCTTA	GTGGGAGCTT	ACAGTTAGAT
<i>F. subglutinans</i> (M3935)	.....	.....	.....	.....	.....	.....
<i>F. subglutinans</i> (Fst9)	.....	.....	.....	.....	.....	.....
<i>F. subglutinans</i> (Fst10)	nnnnnnn...	.....	.....	.....	.....	.....
<i>F. subglutinans</i> (Fst13)	.....	.....	.....	.....	.....	.....
<i>F. subglutinans</i> (Fst17)	.....	.....	.....	.....	.....	.....
<i>F. subglutinans</i> (Fst22)	.....	.....	.....	.....	.....	.....
<i>F. subglutinans</i> (Fst26)	.....	.....	.....	.....	.....	.....
<i>F. subglutinans</i> (Fst40)	.....	.....	.....	.....	.....	.....
<i>F. subglutinans</i> (Fst51)	nnnnnnnnnn	nnnnnnnnnn	.....	.....	.....	.....
<i>F. subglutinans</i> (Fst54)	.....	.....	.....	.....	.....	.....
<i>F. subglutinans</i> (Fst58)	nnnnnnnnnn	nnnnnnnnnn	nn.....	.....	.....	.....
<i>F. subglutinans</i> (Fst69)	nnnnnnnnnn	nnnnnnnnnn	.....	.....	.....	.....
<i>F. subglutinans</i> (MRC115)	.....	.....	.....	.....	.....	.....
<i>F. subglutinans</i> (MRC714)	nnnnnnnnnn	nnnnnnnnnn	.....	.....	.....	.....
<i>F. subglutinans</i> (MRC756)	.....	.....	.....	.....	.....	.....
<i>F. subglutinans</i> (MRC837)	.....	.....	.....	.....	.....	.....
<i>F. subglutinans</i> (MRC1077)	.....	.....	.....	.....	.....	.....
<i>F. subglutinans</i> (MRC1084)	.....	.....	.....	.....	.....	.....
<i>F. subglutinans</i> (KSU434)	.....	.....	.....	.....	.....	.....
<i>F. subglutinans</i> (KSU507)	nnnnnnnnnn	.....	.....	.....	.....	.....
<i>F. subglutinans</i> (KSU731)	nnnnnnnnnn	nnnnnnnnnn	nnn.....	.....	.....	.....
<i>F. subglutinans</i> (KSU993)	.....	.....	.....	.....	.....	.....
<i>F. subglutinans</i> (KSU1257)	nnnnnnnnnn	nnnnnnnnnn	.....	.....	.....	.....
<i>F. subglutinans</i> (KSU1417)	nnnnnnnnnn	nnnnnnnnnn	.....	.....	.....	.....
<i>F. subglutinans</i> (KSU2921)	nnnnnnnnnn	nnnnnnnnnn	n.....	.....	.....	.....
<i>F. subglutinans</i> (KSU3851)	.....	.....	.....	.....	.....	.....
<i>F. subglutinans</i> (MRC6512)	.....	.....	.....	.....	.....	.....
<i>F. subglutinans</i> (MRC6483)	.....	.....	.....	.....	.....	.....

	70	80	90	100	110	120
<i>F. subglutinans</i> (M3869)	CAGTCTCCAG	CACAGAAGAC	GATATGATGA	GCGCAGTGGC	GTGCTAGACA	TCTGTAGTGT
<i>F. subglutinans</i> (M3935)	.....	.....	.....	.....	.....	.....
<i>F. subglutinans</i> (Fst9)	.....	.....	.....	.....	.....	.....
<i>F. subglutinans</i> (Fst10)	.....G.	.....	.....	.....	.....	.....
<i>F. subglutinans</i> (Fst13)	.....G.	.....	.....	.....	.....	.....
<i>F. subglutinans</i> (Fst17)	.....G.	.....	.....	.....	.....	.....
<i>F. subglutinans</i> (Fst22)	.....G.	.....	.....	.....	.....	.....
<i>F. subglutinans</i> (Fst26)	.....	.....	.....	.....	.....	.....
<i>F. subglutinans</i> (Fst40)	.....G.	.....	.....	.....	.....	.....
<i>F. subglutinans</i> (Fst51)	.....	.....	.....	.....	.....	.....
<i>F. subglutinans</i> (Fst54)	.....	.....	.....	.....	.....	.....
<i>F. subglutinans</i> (Fst58)	.....	.....	.....	.....	.....	.....
<i>F. subglutinans</i> (Fst69)	.....	.....	.....	.....	.....	.....
<i>F. subglutinans</i> (MRC115)	.....G.	.....	.....	.....	.....	.....
<i>F. subglutinans</i> (MRC714)	.....G.	.....	.....	.....	.....	.....
<i>F. subglutinans</i> (MRC756)	.....	.....	.....	.....	.....	.....
<i>F. subglutinans</i> (MRC837)	.....	.....	.....	.....	.....	.....
<i>F. subglutinans</i> (MRC1077)	.....	.....	.....	.....	.....	.....
<i>F. subglutinans</i> (MRC1084)	.....	.....	.....	.....	.....	.....
<i>F. subglutinans</i> (KSU434)	.....G.	.....	.....	.....	.....	.....
<i>F. subglutinans</i> (KSU507)	.....G.	.....	.....	.....	.....	.....
<i>F. subglutinans</i> (KSU731)	.....G.	.....	.....	.....	.....	.....
<i>F. subglutinans</i> (KSU993)	.....G.	.....	.....	.....	.....	.....
<i>F. subglutinans</i> (KSU1257)	.....G.	.....	.....	.....	.....	.....
<i>F. subglutinans</i> (KSU1417)	.....G.	.....	.....	.....	.....	.....
<i>F. subglutinans</i> (KSU2921)	.....G.	.....	.....	.....	.....	.....
<i>F. subglutinans</i> (KSU3851)	.....G.	.....	.....	.....	.....	.....
<i>F. subglutinans</i> (MRC6512)	.....G.	.....	.....	.....	.....	.....
<i>F. subglutinans</i> (MRC6483)	.....G.	.....	.....	.....	.....	.....





	130	140	150	160	170	180
<i>F. subglutinans</i> (M3869)	ACTACCTATA	CCTACTGCAC	AGCAAGGTAG	TACTGTGTAG	GTAGTAGTTT	AGTTACCTAC
<i>F. subglutinans</i> (M3935)	.....	.....	.....	.....	.....	.....
<i>F. subglutinans</i> (Fst9)	.....	.....	.....	.....	.....	.....nnnnnnnn
<i>F. subglutinans</i> (Fst10)	.....	.....	.....	.....	.....	.....
<i>F. subglutinans</i> (Fst13)	.....	.....	.....	.....	.....	.....
<i>F. subglutinans</i> (Fst17)	.....	.....	.....	.....	.....	.....
<i>F. subglutinans</i> (Fst22)	.....	.....	.....	.....	.....	.....
<i>F. subglutinans</i> (Fst26)	.....	.....	.....	.....	.....	.....nnnnnnnn
<i>F. subglutinans</i> (Fst40)	.....	.....	.....	.....	.....	.....
<i>F. subglutinans</i> (Fst51)	.....	.....	.....	.....	.....	.....
<i>F. subglutinans</i> (Fst54)	.....	.....	.....	.....	.....	.....
<i>F. subglutinans</i> (Fst58)	.....	.....	.....	.....	.....	.....
<i>F. subglutinans</i> (Fst69)	.....	.....	.....	.....	.....	.....
<i>F. subglutinans</i> (MRC115)	.....	.....	.....	.....	.....	.....
<i>F. subglutinans</i> (MRC714)	.....	.....	.....	.....	.....	.....
<i>F. subglutinans</i> (MRC756)	.....	.....	.....	.....	.....	.....
<i>F. subglutinans</i> (MRC837)	.....	.....	.....	.....	.....	.....
<i>F. subglutinans</i> (MRC1077)	.....	.....	.....	.....	.....	.....
<i>F. subglutinans</i> (MRC1084)	.....	.....	.....	.....	.....	.....
<i>F. subglutinans</i> (KSU434)	.....	.....	.....	.....	.....	.....
<i>F. subglutinans</i> (KSU507)	.....	.....	.....	.....	.....	.....
<i>F. subglutinans</i> (KSU731)	.....	.....	.....	.....	.....	.....
<i>F. subglutinans</i> (KSU993)	.....	.....	.....	.....	.....	.....
<i>F. subglutinans</i> (KSU1257)	.....	.....	.....	.....	.....	.....
<i>F. subglutinans</i> (KSU1417)	.....	.....	.....	.....	.....	.....
<i>F. subglutinans</i> (KSU2921)	.....	.....	.....	.....	.....	.....
<i>F. subglutinans</i> (KSU3851)	.....	.....	.....	.....	.....	.....
<i>F. subglutinans</i> (MRC6512)	.....	.....	.....	.....	.....	.....
<i>F. subglutinans</i> (MRC6483)	.....	.....	.....	.....	.....	.....

	190	200	210	220	230	236
<i>F. subglutinans</i> (M3869)	CT-----TAG	----TACCTA	GGCTTTTACT	TTCTGACACT	GGCATATCTG	AATCGT
<i>F. subglutinans</i> (M3935)	.....	.....	.....	.....	.....	.....
<i>F. subglutinans</i> (Fst9)	nn.....	.....	.....	.....	.....	.....
<i>F. subglutinans</i> (Fst10)	.....	.....	.....	.....	.....	.....
<i>F. subglutinans</i> (Fst13)	.....	.....	.....	.....	nnnnnnnnnn	nnnnnn
<i>F. subglutinans</i> (Fst17)	.....	.....	.....	.....	.....nnnnnnnn	nnnnnn
<i>F. subglutinans</i> (Fst22)	.....	.....	.....	.....	.....nnnnnnnn	nnnnnn
<i>F. subglutinans</i> (Fst26)	nn.....	.....	.....	.....	.....	.....
<i>F. subglutinans</i> (Fst40)	.....	.....	.....	.....	.....	.....
<i>F. subglutinans</i> (Fst51)	.....	.....	.....	.....	.....	.....
<i>F. subglutinans</i> (Fst54)	.....	.....	.....	.....	.....nnnnnnnn	nnnnnn
<i>F. subglutinans</i> (Fst58)	.....	.....	.....	.....	.....	.....
<i>F. subglutinans</i> (Fst69)	.....	.....	.....	.....	.....	.....
<i>F. subglutinans</i> (MRC115)	.....	.....	.....	.....	.....	.....
<i>F. subglutinans</i> (MRC714)	.....	.....	.....	.....	.....	.....
<i>F. subglutinans</i> (MRC756)	.....	.....	.....	.....	.....	.....
<i>F. subglutinans</i> (MRC837)	.....	.....	.....	.....	.....	.....
<i>F. subglutinans</i> (MRC1077)	.....	.....	.....	.....	.....	.....
<i>F. subglutinans</i> (MRC1084)	.....	.....	.....	.....	.....	.....
<i>F. subglutinans</i> (KSU434)	.....	.....	.....	.....	.....	.....
<i>F. subglutinans</i> (KSU507)	.....	.....	.....	.....	nnnnnnnnnn	nnnnnn
<i>F. subglutinans</i> (KSU731)	.....	.....	.....	.....	.....	.....
<i>F. subglutinans</i> (KSU993)	.....	.....	.....	.....	.....	.....
<i>F. subglutinans</i> (KSU1257)	.....	.....	.....	.....	.....	.....
<i>F. subglutinans</i> (KSU1417)	.....	.....	.....	.....	.....	.....
<i>F. subglutinans</i> (KSU2921)	.....	.....	.....	.....	.....	.....
<i>F. subglutinans</i> (KSU3851)	.....	.....	.....	.....	.....	.....
<i>F. subglutinans</i> (MRC6512)	.....	.....	.....	.....	.....	.....
<i>F. subglutinans</i> (MRC6483)	.....	.....	.....	.....	.....	.....

## APPENDIX 6

Aligned elongation factor 1 $\alpha$ , calmodulin,  $\beta$ -tubulin and mitochondrial ribosomal small subunit (mtSSU) DNA sequences for 12 *Fusarium* spp. representing *F. subglutinans sensu lato* (Chapter 7 of this thesis). Representatives for the *Gibberella fujikuroi* mating populations (MP-A to MP-H) are also included. Nucleotides similar to those of *F. inflexum* are indicated as dots, whereas nucleotide deletions are indicated by vertical lines (-).

### Elongation factor 1 $\alpha$

	10	20	30	40	50	60
<i>F. inflexum</i>	TCGTCGTCAT	CGGCCACGTC	GACTCTGGCA	AGTCGACCAC	TGTGAGTACT	CTCCTCGACA
<i>Fusarium</i> sp. 2	.....	.....	.....	.....	.....	AC....T..G
<i>Fusarium</i> sp. 4	.....	.....	.....	.....	.....A	AC.....G
<i>F. guttiforme</i>	.....	.....	.....	.....	.....	AC.....G
<i>F. begoniae</i>	.....	.....	.....	.....	.....	AC.....G
<i>F. bulbicola</i>	.....	.....	.....	.....	.....	AC.G....G
<i>F. circinatum</i> (MP-H)	.....	.....	.....	.....	.....	AC.....G
<i>F. subglutinans</i> (MP-E)	.....	.....	.....	.....	.....	AC.....G
<i>Fusarium</i> sp. 1	.....	.....	.....	.....	.....	AC.....G
<i>F. thapsinum</i> (MP-F)	.....	.....	.....	.....	.....	AC...A..G
<i>F. verticillioides</i> (MP-A)	.....	.....	.....	.....	.....	AC..T...G
<i>F. nygamai</i> (MP-G)	.....	.....	.....	.....	.....	AC.....G
<i>F. pseudocircinatum</i>	.....	.....	.....	.....	.....	AC.....G
<i>F. concentricum</i>	.....	.....	.....	.....	.....	AC..CT...G
<i>Fusarium</i> sp. 3	.....	.....	.....	.....	.....	AC..T..TG
<i>F. sacchari</i> (MP-B)	.....	.....	.....	.....	.....	AC.....G
<i>F. fujikuroi</i> (MP-C)	.....	.....	.....	.....	.....	AC.....G
<i>F. proliferatum</i> (MP-D)	.....	.....	.....	.....	.....	AC...G...G

	70	80	90	100	110	120
<i>F. inflexum</i>	ATGAGCATAT	CTGCCATCGT	CAATCCCGAC	CAAGACCTGG	CGGGGTATTT	CTC--AAAG-
<i>Fusarium</i> sp. 2	.....T...	.....	T-.....	.....T...	.....--	.A.--C...A
<i>Fusarium</i> sp. 4	.....T...	.....	-.....	.....T...	.....--	.....A
<i>F. guttiforme</i>	.....T...	.....	T-.....	.....	.....--	.....A
<i>F. begoniae</i>	.....T...	.....	T-.....	.....	.....--	.....A
<i>F. bulbicola</i>	.....T...	.....	T-.....	.....	.....G--	.....A
<i>F. circinatum</i> (MP-H)	.....T...	.....	G-.....	.....	.....--	.....A
<i>F. subglutinans</i> (MP-E)	.....T...	.....	T-.....	.....	.....A...--	.....A
<i>Fusarium</i> sp. 1	.....T...	.....	T-.....	.....	.....-C--	.....A...A
<i>F. thapsinum</i> (MP-F)	.....T...	.....	-..C.....	.....	.....A.....	.....A...A
<i>F. verticillioides</i> (MP-A)	.....T...	..G.....	-..A...G..	.....	.....A.....	T..--...A
<i>F. nygamai</i> (MP-G)	.....T...	.....	-.....	.....	.....	.....AA...A
<i>F. pseudocircinatum</i>	.....T...	.....A..	-.....	.....A.....	.....G.....	.....-A...-
<i>F. concentricum</i>	.....T...	.....	-.....T...	.....T...	.....G.A..	.....-A...A
<i>Fusarium</i> sp. 3	.....T...	.....	-.....T...	.....T.C..	.....A.....	.....-A...A
<i>F. sacchari</i> (MP-B)	.....G.....	.....A..	-..C..TC..	.....	.....A.....C	.....TTG...-A
<i>F. fujikuroi</i> (MP-C)	.....T...	.....T-.....	-.....T...	.....A.T...	.....A.....	.....A-G...A
<i>F. proliferatum</i> (MP-D)	T.....T...	.....	G-.....T...	.....T...	.....CA..	.....TG-G...A



	130	140	150	160	170	180
<i>F. inflexum</i>	TCAACATACT	GACATCGTTT	CACAGACCGG	TCACTTGATC	TACCAGTGCG	GTGGTATCGA
<i>Fusarium</i> sp. 2	-. . . . . G . .	. . . . . C . C	. . . . .	. . . . .	. . . . .	. . . . .
<i>Fusarium</i> sp. 4	-. . . . . G . .	. . . . . C . .	. . . . .	. . . . .	. . . . .	. . . . .
<i>F. guttiforme</i>	-. . . . . G . .	. . . . . C . C	. . . . .	. . . . .	. . . . .	. . . . .
<i>F. begoniae</i>	-. . . . . G . .	. . . . . C . C	. . . . .	. . . . .	. . . . .	. . . . .
<i>F. bulbicola</i>	-. . . . . G . .	. . . . . C . C	. . . . .	. . . . .	. . . . .	. . . . .
<i>F. circinatum</i> (MP-H)	-. . . . . G . .	. . . . . C . C	. . . . .	. . . . .	. . . . .	. . . . .
<i>F. subglutinans</i> (MP-E)	-. . . . . G . .	. . . . . C . C	. . . . .	. . . . .	. . . . .	. . . . .
<i>Fusarium</i> sp. 1	-. . . . . G . .	. . . . . C . .	. . . . .	. . . . .	. . . . .	. . . . .
<i>F. thapsinum</i> (MP-F)	C-. . T . . G . .	. . T . . C . .	. . T . .	. . . . .	. . . . .	. . . . .
<i>F. verticillioides</i> (MP-A)	A-. . . . . G . .	. . . . . C . .	. . . . .	. . . . .	. . . . .	. . . . .
<i>F. nygamai</i> (MP-G)	C-. . . . . G . .	. . . . . C . .	. . T . .	. . . . .	. . . . .	. . . . .
<i>F. pseudocircinatum</i>	C. . . . . G . .	. . . . . T A C . .	. . . . .	. . . . .	. . . . .	. . . . .
<i>F. concentricum</i>	- . . . . . G . .	. . . . . A . C . .	. . . . .	. . . . .	. . . . .	. . . . .
<i>Fusarium</i> sp. 3	- . . . T . . G . .	. . . . . A . C . .	. . . . .	. . . . .	. . . . .	. . . . .
<i>F. sacchari</i> (MP-B)	- . . . G . . G . .	. . . . . G . C . A	. . . . .	. . . . .	. . . . .	. . . . .
<i>F. fujikuroi</i> (MP-C)	- . G . T . . G . .	. . T . . C . .	. . . . .	. . . . .	. . . . .	. . . . .
<i>F. proliferatum</i> (MP-D)	- . . . . . G . .	. . . . . C . .	. . . . .	. . . . .	. . . . .	. . . . .

	190	200	210	220	230	240
<i>F. inflexum</i>	CAAGCGAACC	ATCGAGAAGT	TCGAGAAGGT	TAGTCACTTT	CCCTTCAATC	GCGCGTCCTT
<i>Fusarium</i> sp. 2	. . . . .	. . . . .	. . . . .	. . . . . T . . . .	. . . . .	. . . . .
<i>Fusarium</i> sp. 4	. . . . .	. . . . .	. . . . .	. . . . . T . . . .	. . . . . G . . . .	. . . . .
<i>F. guttiforme</i>	. . . . .	. . . . .	. . . . .	. . . . . T . . . .	. . . . . G . . . .	. . . . .
<i>F. begoniae</i>	. . . . .	. . . . .	. . . . .	. . . . . T . . . .	. . . . . G . . . .	. . . . .
<i>F. bulbicola</i>	. . . . .	. . . . .	. . . . .	. . . . . T . . . .	. . . . . G . . . .	. . . . .
<i>F. circinatum</i> (MP-H)	. . . . .	. . . . . T . . . .	. . . . .	. . . . . T . . . .	. . . . . G . . . .	. . . . .
<i>F. subglutinans</i> (MP-E)	. . . . .	. . . . .	. . . . .	. . . . . T . . . .	. . . . . G . . . .	. . . . .
<i>Fusarium</i> sp. 1	. . . . .	. . . . .	. . . . .	. . . . . T . . . .	. . . . . G . . . .	. . . . .
<i>F. thapsinum</i> (MP-F)	. . . . .	. . . . .	. . . . .	. . . . .	. . . . . G . . . .	. . . . . C . . . .
<i>F. verticillioides</i> (MP-A)	. . . . .	. . . . .	. . . . .	. . . . .	T . . . . T . . . .	. . . . . T . . . .
<i>F. nygamai</i> (MP-G)	. . . . .	. . . . .	. . . . .	. . . . .	. . . . . G . . . .	. . . . .
<i>F. pseudocircinatum</i>	. . . . .	. . . . .	. . . . .	. . . . .	. . . . . G . . . .	. . . . .
<i>F. concentricum</i>	. . . . .	. . . . .	. . . . .	. . . . . - - - -	. . . . . G . . . .	. . . . .
<i>Fusarium</i> sp. 3	. . . . .	. . . . .	. . . . .	. . . . . - - - -	. . . . . G . . . .	. . . . . T . . . .
<i>F. sacchari</i> (MP-B)	. . . . .	. . . . .	. . . . .	. . . . .	. . . . . G . . . .	. . . . .
<i>F. fujikuroi</i> (MP-C)	. . . . .	. . . . .	. . . . .	. . . . .	. . . . . G . . . .	. . . . .
<i>F. proliferatum</i> (MP-D)	. . . . .	. . . . .	. . . . .	. . . . .	. . . . . G . . . .	. . . . . C . . . .

	250	260	270	280	290	300
<i>F. inflexum</i>	TGCCCATCG-	ATTTCCCC-T	ACGACTCGAA	ACGTGCCCGC	TACCCCGCTC	GAGACCAAAA
<i>Fusarium</i> sp. 2	. . . . . - . . . .	. . . . . T . . A . .	. . . . .	. . . . .	. . . . .	. . . . .
<i>Fusarium</i> sp. 4	. . . . . - . . . .	. . . . . - A T . . A . .	. . . . .	. . . . .	. . . . .	. . . . .
<i>F. guttiforme</i>	. . . . . - . . . .	. . . . . - G . . A . .	. . . . .	. . . . .	. . . . .	. . . . .
<i>F. begoniae</i>	. . . . . - . . . .	. . . . . - T . . A . .	. . . . .	. . . . .	. . . . .	. . . . .
<i>F. bulbicola</i>	. . . . . - G . . . .	. . . . . - T . . A . .	. . . . .	. . . . .	. . . . .	. . . . .
<i>F. circinatum</i> (MP-H)	. . . . . - . . . .	. . . . . - T . . A . .	. . . . .	. . . . .	. . . . .	. . . . .
<i>F. subglutinans</i> (MP-E)	. . . . . - . . . .	. . . . . - T . . A . .	T . . . . .	. . . . .	. . . . .	. . . . .
<i>Fusarium</i> sp. 1	. . . . . - . . . .	. . . . . - T . . A . .	. . . . .	. . . . .	. . . . .	. . . . .
<i>F. thapsinum</i> (MP-F)	. . T . . . . - . . . .	. . - A . . C . .	. . . . .	. . T . . . . .	. . . . .	. . T T - . . . .
<i>F. verticillioides</i> (MP-A)	. . . . . - . . . .	. . . . . C . . . .	. . . . .	. . . . . A . . . .	. . . . .	. . . . . C . . . .
<i>F. nygamai</i> (MP-G)	. . T . . . . - . . . .	. . . . . C . . . .	. . . . .	. . . . .	. . . . .	. . . . . A T T . . . .
<i>F. pseudocircinatum</i>	. A T . . . . - . . . .	. . . . . C . . . .	. . . . .	. . . . .	. . . . .	. . . . . T . . . .
<i>F. concentricum</i>	. . . . . - . . . .	. . . . . T . . C . .	. . . . .	. . . . .	. . . . .	. . . . .
<i>Fusarium</i> sp. 3	. . . . . G . . - . . . .	. . . . . T . . - . . . .	. . . . . T . . . .	. . . . .	. . . . .	. . . . .
<i>F. sacchari</i> (MP-B)	. . T A . . . . - . . . .	. . . . . - . . . .	. . . . .	. . . . .	. . . . .	. . . . .
<i>F. fujikuroi</i> (MP-C)	. . . . . C . . - . . . .	. . . . . T - . . . .	. . . . . G T . . . .	. . . . . T . . . .	. . . . .	. . . . . T . . . .
<i>F. proliferatum</i> (MP-D)	. . . . . C . . - . . . .	. . . . . A . T - . . . .	. . . . . G . . T . . . .	. . . . . T . . . .	. . . . .	. . . . .



	310	320	330	340	350	360
<i>F. inflexum</i>	ATTTTGCAAT	ATGACCGTAA	TTTTTTT--G	GTGGGGCACT	TACCCCGCCA	CTTGAGCGAA
<i>Fusarium</i> sp. 2	.....G..	.....	.....--	.....T.	.....	..C.....T
<i>Fusarium</i> sp. 4	.....G..	.....	.....--	.....T.	.....	..C.....-
<i>F. guttiforme</i>	.....G.C	.....	.....--	.....T.	.....	..C.....T
<i>F. begoniae</i>	.....G..	.....	.....--	.....T.	.....	..C.....T
<i>F. bulbicola</i>	.....G..	.....	.....--	.....T.	.....	..C.....T
<i>F. circinatum</i> (MP-H)	.....G..	.....	.....T-	.....T.	.....	..C.....T
<i>F. subglutinans</i> (MP-E)	.....G..	.....	.....T-	.....T.	.....	..C.....T
<i>Fusarium</i> sp. 1	.A.....G..	.....	.....--	.....T.	.....	..C...A.T
<i>F. thapsinum</i> (MP-F)	.....G..	.....A..	.....C--	.....T.	.....	..C.....T
<i>F. verticillioides</i> (MP-A)	.....G..	.....	.....CT-	.....A..T.	.....	..C.....--
<i>F. nygamai</i> (MP-G)	.....G..	.....	.....--	.....T.	.....	..C.....--
<i>F. pseudocircinatum</i>	T.....G..	.....	.....--	.....CT.	.....	..C.....--
<i>F. concentricum</i>	.....G..	.....	.....--	.....T.	.....	..C.....T
<i>Fusarium</i> sp. 3	.....G..	.....	.....TT.	.....T.	.....	..C.....T
<i>F. sacchari</i> (MP-B)	.....G..	.....	.....--	.....T.	.....	..C.....T
<i>F. fujikuroi</i> (MP-C)	.....G..	.....	.....T-	.....T.	.....	..C...T..T
<i>F. proliferatum</i> (MP-D)	.....G..	.....	.....--	.....T.	.....	..C.....T

	370	380	390	400	410	420
<i>F. inflexum</i>	GGGAGCG--T	TTGCCCTCTT	ACCATTCT-C	ACAACCT-CA	ATGAGTGCCT	CGTCACGTGT
<i>Fusarium</i> sp. 2	--.C...TT.	C.....--	---.T.T.	.....T--	C...C..A.	.....
<i>Fusarium</i> sp. 4	--.C...TT.	C.....--	---.T.C.	.....T--	C...C..A.	.....
<i>F. guttiforme</i>	--.C...TT.	C.....--	---.TGC.	.....T--	C...C..A.	.....
<i>F. begoniae</i>	--.C...TT.	C.....--	---.TGC.	.....T--	C...C..A.	.....
<i>F. bulbicola</i>	--.C...TT.	C.....--	---.T.C.	.....T--	C...C..A.	.....
<i>F. circinatum</i> (MP-H)	--.C...TT.	C.....C-	---.TGC.	.....T--	C...C..A.	.....
<i>F. subglutinans</i> (MP-E)	--.C...TT.	C.....--	---.T.-	.....T--	C...C..A.	.....C
<i>Fusarium</i> sp. 1	--.C...TT.	C.....C-	---.TGC.	.....T--	C...C..A.	.....
<i>F. thapsinum</i> (MP-F)	..C...CTT.	.A.....--	---.-----	.....CA.	C...C..A.	T.....
<i>F. verticillioides</i> (MP-A)	--.C...TT.	C.....--	C...--T.C.	.....CA-	C...CT.A.	.....
<i>F. nygamai</i> (MP-G)	--.C...TT.	.....	C...--T.C.	.....CA-	C...C..A.	.....
<i>F. pseudocircinatum</i>	--.C...TT.	.....	CT...--T.C.	.....CA-	C...C..A.	.....
<i>F. concentricum</i>	..C...--	.....--	---.----.C.	.....T..CA.	-...C..A.	.....C
<i>Fusarium</i> sp. 3	..C...--	.....--	---.----.C.	.....CA.	-...C..A.	.....
<i>F. sacchari</i> (MP-B)	..C...TC.	.....T.C	CT-...--.C.	.....T.CA.	-...C..A.	.....
<i>F. fujikuroi</i> (MP-C)	..C...-T.	.....T.C	CT-G---.C.	.....CA.	-...C..AA	T.....
<i>F. proliferatum</i> (MP-D)	..C...GT.	.....T.C	CT-G---.C.	.....CA.	-...C..A.	T.....

	430	440	450	460	470	480
<i>F. inflexum</i>	GAAGCAGTCA	CTAACCATTC	AACAATAGGA	AGCCGCTGAG	CTCGGTAAGG	GTTCCCTCAA
<i>Fusarium</i> sp. 2	C.....	.....C.	G.....	.....	.....	.....
<i>Fusarium</i> sp. 4	T.....	.....	G.....	.....	.....	.....
<i>F. guttiforme</i>	T.....	.....	G.....	.....	.....C.	.....
<i>F. begoniae</i>	T.....	.....	G.....	.....	.....	.....
<i>F. bulbicola</i>	T.....	.....	G.....	.....	.....	.....
<i>F. circinatum</i> (MP-H)	T.....	.....TT.	G.....	.....	.....	.....
<i>F. subglutinans</i> (MP-E)	T.....	.....	.....	.....C.	.....	.....
<i>Fusarium</i> sp. 1	T.....	.....	GT.....	.....	.....	.....
<i>F. thapsinum</i> (MP-F)	C.....	.....C.	G.....	.....	.....	.....
<i>F. verticillioides</i> (MP-A)	C.....	.....C.	G.....	.....	.....	.....
<i>F. nygamai</i> (MP-G)	C.....	.....	G.....	.....	.....	.....
<i>F. pseudocircinatum</i>	C...T.....	.....G..	G.....	.....	.....	.....
<i>F. concentricum</i>	C.....	.....C.	G.....	.....	.....	.....
<i>Fusarium</i> sp. 3	C.....	.....C.	G.....	.....	.....	.....
<i>F. sacchari</i> (MP-B)	C.....	.....T..CT	G.....	.....	.....	.....
<i>F. fujikuroi</i> (MP-C)	C.....	.....A..	G.....	.....	.....	.....
<i>F. proliferatum</i> (MP-D)	C.....CG.	.....	G.....	.....	.....	.....



	490	500	510	520	530	540
<i>F. inflexum</i>	GTACGCCTGG	GTTCTTGACA	AGCTCAAGGC	CGAGCGTGAG	CGTGGTATCA	CCATCGATAT
<i>Fusarium</i> sp. 2	.....	.....	.....	.....	.....	.....
<i>Fusarium</i> sp. 4	.....	.....	.....	.....	.....	.....
<i>F. guttiforme</i>	.....	.....	.....	.....	.....	.....
<i>F. begoniae</i>	..T.....	.....	.....	.....	.....	.....
<i>F. bulbicola</i>	.....	.....	.....	.....	.....	.....
<i>F. circinatum</i> (MP-H)	.....	.....	.....	.....	.....	.....
<i>F. subglutinans</i> (MP-E)	.....	.....	T.....	.....	.....	.....
<i>Fusarium</i> sp. 1	.....	.....	.....	.....	.....	.....
<i>F. thapsinum</i> (MP-F)	.....	.....	.....	.....	.....	.....
<i>F. verticillioides</i> (MP-A)	.....	.....	.....	.....	.....	.....
<i>F. nygamai</i> (MP-G)	.....	.....	.....	.....	.....	.....
<i>F. pseudocircinatum</i>	.....	.....	.....	.....	.....	.....
<i>F. concentricum</i>	.....	.....	.....	.....	.....	.....
<i>Fusarium</i> sp. 3	.....	.....	.....	.....	.....	.....
<i>F. sacchari</i> (MP-B)	.....	.....	.....	.....	.....	.....
<i>F. fujikuroi</i> (MP-C)	.....	.....	.....	.....	.....	.....
<i>F. proliferatum</i> (MP-D)	.....	.....	.....	.....	.....	.....

	550	560	570	580	590	600
<i>F. inflexum</i>	TGCTCTCTGG	AAGTTCGAGA	CTCCTCGCTA	CTATGTCACC	GTCATTGGTA	TGTTGTCGCT
<i>Fusarium</i> sp. 2	.....	.....	.....	.....	.....	.....
<i>Fusarium</i> sp. 4	.....	.....	.....	.....	.....	.....
<i>F. guttiforme</i>	.....	.....	.....	.....	.....	.....
<i>F. begoniae</i>	.....	.....	.....	.....	.....	.....
<i>F. bulbicola</i>	.....	.....	.....	.....	.....	.....
<i>F. circinatum</i> (MP-H)	.....	.....	.....	.....	.....	.....A..
<i>F. subglutinans</i> (MP-E)	.....	.....	.....	.....	.....	.....
<i>Fusarium</i> sp. 1	.....	.....	.....	.....T	.....	.....
<i>F. thapsinum</i> (MP-F)	.....	.....	.....	.....	.....	.....
<i>F. verticillioides</i> (MP-A)	C.....	.....	.....	.....	.....	.....C.....
<i>F. nygamai</i> (MP-G)	.....	.....	.....	.....	.....	.....
<i>F. pseudocircinatum</i>	.....	.....	.....	.....	.....	.....C....
<i>F. concentricum</i>	C.....	.....	.....	.....	.....	.....C
<i>Fusarium</i> sp. 3	.....	.....	.....	.....	.....	.....
<i>F. sacchari</i> (MP-B)	.....	.....	.....C.....	.....	.....	.....
<i>F. fujikuroi</i> (MP-C)	.....T.....	.....	.....	.....	.....	.....
<i>F. proliferatum</i> (MP-D)	.....	.....	.....	.....	.....	.....

	610	620	630	640	650	660
<i>F. inflexum</i>	CATGCTTCAT	TCTACTTCTC	TTCGTAATA	CATATCACTC	AGACGCTCCC	GGTCACCGTG
<i>Fusarium</i> sp. 2	.....C..G.	...C.C.T.A	.....	.....	.....	.....T....
<i>Fusarium</i> sp. 4	.....C..G.	...C.C.T.A	.....	.....	.....	.....T....
<i>F. guttiforme</i>	.....C..G.	...C.C.T--	-----	-----	-----	-----
<i>F. begoniae</i>	.....C..G.	...C.C.T.A	...A.....	...G.....	.....	.....T....
<i>F. bulbicola</i>	.....C..G.	...C.C.T.A	.....	.....	.....	.....T....
<i>F. circinatum</i> (MP-H)	.....C..G.	...C.C.TCA	.....	.....	.....	.....T....
<i>F. subglutinans</i> (MP-E)	.....A.TG.	...C.C.T.A	.....	.....	.....	.....T....
<i>Fusarium</i> sp. 1	.....C..G.	...C.C.TAA	.....	.....	.....	.....T....
<i>F. thapsinum</i> (MP-F)	.....	...A.....	...--.....	T..T.....	.....	.....
<i>F. verticillioides</i> (MP-A)	.T.A..C.G.	...TA.....	C.AT.....	..C....AT	.....	.....
<i>F. nygamai</i> (MP-G)	..T.....	...A.....	...T.....	.....	.....	.....
<i>F. pseudocircinatum</i>	.....	...A.....	...T.....	...G.....	...C.....	.....
<i>F. concentricum</i>	.....	...T.-.-.	C.....	.....	.....	.....
<i>Fusarium</i> sp. 3	.....	...T.-.-.	C.....	.....	.....	.....
<i>F. sacchari</i> (MP-B)	.....C.T.C	...--T..	C.A.....	...G.....	.....	.....
<i>F. fujikuroi</i> (MP-C)	...TG.....	...--A...	...A.....	...T.....	.....	.....
<i>F. proliferatum</i> (MP-D)	...A.C....	C.....-.-.	C.AC.CT..	..C....T..	.....	.....





## Calmodulin

	10	20	30	40	50	60
<i>F. inflexum</i>	GAAGCTGTCG	CTAACCTCTT	TATGTAGGAC	AAGGATGGCG	ATGGTGAGTG	ATGCTCCCCT
<i>Fusarium</i> sp. 2	.....	.....	.....	.....	.....	.....
<i>Fusarium</i> sp. 4	.....	.C.....	.....	..?.....	.....	.....
<i>F. guttiforme</i>	.....	.....	...C.....	.....	.....	.....
<i>F. begoniae</i>	.....	.....	.....	.....	.....	.....
<i>F. bulbicola</i>	.....	.....	.....	.....	.....	.....
<i>F. circinatum</i> (MP-H)	.....	.....	.....	.....	.....	.....
<i>F. subglutinans</i> (MP-E)	.....	.....	...CC.....	.....	.....	.....
<i>Fusarium</i> sp. 1	.....	.....	...CC.....	.....	.....	.....
<i>F. thapsinum</i> (MP-F)	.....	.....	.....	.....	.....	.....
<i>F. verticillioides</i> (MP-A)	.....	.....	.....	.....	.....	.....
<i>F. nygamai</i> (MP-G)	.....	.....	.....	.....	.....	.....
<i>F. pseudocircinatum</i>	.....	.....C.....	.....	.....	.....	..A.....
<i>F. concentricum</i>	.....	.....GC.....	.....	.....	.....	.....
<i>Fusarium</i> sp. 3	.....	.....GC.....	.....	.....	.....	.....
<i>F. sacchari</i> (MP-B)	.....	.....	C.....	.....	.....	..-.....
<i>F. fujikuroi</i> (MP-C)	.....	.....C.....	.....	.....	.....	.....
<i>F. proliferatum</i> (MP-D)	.....	.....C.....	..A.....	.....	.....	.....

	70	80	90	100	110	120
<i>F. inflexum</i>	TTCCGCGATG	TTTCTTCGTT	GGCCCCGTGC	GAAACCC-AA	ATCGATCCAA	CAAAGCAT--
<i>Fusarium</i> sp. 2	.....	.....	.....	.....-	.....	..G.....GC
<i>Fusarium</i> sp. 4	.....	.....	.....	.....-	.....	..G.....GC
<i>F. guttiforme</i>	.....	.....	.....	.....-	.....	..G.....GC
<i>F. begoniae</i>	.....	.....	.....	.....-	.....	..G.....GC
<i>F. bulbicola</i>	.....	.....	.....	.....-	.....	.....GC
<i>F. circinatum</i> (MP-H)	.....	.....	.....	.....-	.....	.....GC
<i>F. subglutinans</i> (MP-E)	.....	.....	.....	.....-	.....	.....GC
<i>Fusarium</i> sp. 1	.....	.....	.....	.....-	.....	.....GC
<i>F. thapsinum</i> (MP-F)	.....	.....C.....	.....	.....-	G.....	.....GC
<i>F. verticillioides</i> (MP-A)	.C.T.....	.....C.....	.....	.....-	.....	.....GC
<i>F. nygamai</i> (MP-G)	.C.....	.....C.....	.....	.....-	.....	.....GC
<i>F. pseudocircinatum</i>	.C.....	.....C.....	.....	.....-	G.....	.....G.GC
<i>F. concentricum</i>	.....C.A.....	.....	.....	.....A.....	.....	.....GC
<i>Fusarium</i> sp. 3	.....C.A.....	.....	.....	.....A.....	.....	.....GC
<i>F. sacchari</i> (MP-B)	..T..C.G.....	.....G.....	.....	-C..A.....	.....	.....GC
<i>F. fujikuroi</i> (MP-C)	.....C.A.....	.....	.....	.....A.....	.....	.....GC
<i>F. proliferatum</i> (MP-D)	.....C.A.....	.....	.....	.....A.....	.....	.....GC

	130	140	150	160	170	180
<i>F. inflexum</i>	--CAGACCAC	TATAACTCTT	TACATCTCTT	TCTATGCGAT	ATTCTTAAAT	CGAAAACATG
<i>Fusarium</i> sp. 2	AT.....	.....TC..C.....	.....G.....	.....	.....	.....G.....
<i>Fusarium</i> sp. 4	AT.....	.....TC..C.....	.....G.....	.....	.....	.....G.....
<i>F. guttiforme</i>	AT.....	.....TC..C.....	.....G.....	.....	.....	.....G.....
<i>F. begoniae</i>	AT.....	.....TC..C.....	..?.....G.....	.....	.....	.....G.....
<i>F. bulbicola</i>	AT.....	.....TC..C.....	.....G.....	.....	.....	.....G.....
<i>F. circinatum</i> (MP-H)	AT.....	.....TC..C.....	.....G.....	.....A.....	..C.....	.....G.....
<i>F. subglutinans</i> (MP-E)	AT.....	.....TC..C.....	.....G.....	.....	.....	.....G.....
<i>Fusarium</i> sp. 1	AT.....	.....TC..C.....	.....G.....	.....	.....	.....G.....
<i>F. thapsinum</i> (MP-F)	AT.....	.....TCT.....	.....G.G.....	.....	.....C.....	.....
<i>F. verticillioides</i> (MP-A)	AT.....	.....TC.....	.....G.....	.....	.....	.....
<i>F. nygamai</i> (MP-G)	AT.....	.....TC.....	.....G.....	.....	.....	.....
<i>F. pseudocircinatum</i>	AT.....	.....TC.....	.....G.....	.....	.....	.....
<i>F. concentricum</i>	AT.....	..CA..TC.....	.....G.....	.....	.....G..G.....	.....
<i>Fusarium</i> sp. 3	GT.....	..CA..TCA.....	.....G.....	.....	.....G..G.....	.....
<i>F. sacchari</i> (MP-B)	AT.....G.....	..CA..TC.....	.....G.....	.....--.....	.....G..G.....	..A.....
<i>F. fujikuroi</i> (MP-C)	AT.....	..CA..TC.....	.....G.....	.....	.....G..G.....	.....
<i>F. proliferatum</i> (MP-D)	AT.....	..CA..TC.....	.....G.....	.....	.....G..G.....	.....



	190	200	210	220	230	240
<i>F. inflexum</i>	AGCTAAACGC	CTCGCTCTAG	GCCAGATTAC	CACCAAGGAG	CTCGGTACCG	TTATGCGCTC
<i>Fusarium</i> sp. 2	.....	.....T...	.....A.....	.....T.....	.....	.....
<i>Fusarium</i> sp. 4	.....	.....	.....A.....	.....T.....	.....	.....
<i>F. guttiforme</i>	.....	.....	.....A. A..	.....T.....	.....	.....
<i>F. begoniae</i>	.....	.....	.....A.....	.....T.....	.....	.....
<i>F. bulbicola</i>	.....	.....	.....A.....	.....T.....	.....	.....
<i>F. circinatum</i> (MP-H)	.....	.....	.....A.....	.....T.....	.....	.....
<i>F. subglutinans</i> (MP-E)	.....	.....	.....A.....	.....T.....	.....	.....
<i>Fusarium</i> sp. 1	.....	.....	.....A.....	.....T.....	.....	.....
<i>F. thapsinum</i> (MP-F)	.....	.....	.....	.....	.....	.....
<i>F. verticillioides</i> (MP-A)	.....	.....	.....	.....	.....	.....
<i>F. nygamai</i> (MP-G)	.....	.....	.....	.....	.....	.....
<i>F. pseudocircinatum</i>	.....	.....	.....	.....	.....	.....
<i>F. concentricum</i>	.....	G.....	.....	.....	.....T.....	.....
<i>Fusarium</i> sp. 3	.....	G.....	.....	.....	.....	.....
<i>F. sacchari</i> (MP-B)	.....	T.....	.....	.....	.....	.....
<i>F. fujikuroi</i> (MP-C)	.....	G.....	.....	.....	.....	.....
<i>F. proliferatum</i> (MP-D)	.....	G.....	.....	.....	.....	.....

	250	260	270	280	290	300
<i>F. inflexum</i>	TCTCGGCCAG	AACCCCTCCG	AGTCTGAGCT	TCAGGACATG	ATCAACGAGG	TTGACGCCGA
<i>Fusarium</i> sp. 2	.T.....	.T.....	.....	.....	.....	.....
<i>Fusarium</i> sp. 4	.....	.....	.....	.....	.....	.....
<i>F. guttiforme</i>	.....	.....	.....	.....	.....	.....
<i>F. begoniae</i>	.....	.....T.....	.....	.....	.....	.....
<i>F. bulbicola</i>	.....	.....T.....	.....	.....	.....	.....
<i>F. circinatum</i> (MP-H)	.....	.....T.....	.....	.....	.....	.....
<i>F. subglutinans</i> (MP-E)	.....	.....	.....	.....	.....	.....
<i>Fusarium</i> sp. 1	.....	.....	.....	.....	.....	.....
<i>F. thapsinum</i> (MP-F)	.....	.....	.....	.....	.....	.....
<i>F. verticillioides</i> (MP-A)	.....	.....	.....	.....	.....	.....T.....
<i>F. nygamai</i> (MP-G)	.....	.....	.....	.....	.....	.....
<i>F. pseudocircinatum</i>	.....	.....	.....	.....	.....	.....
<i>F. concentricum</i>	.....T.....	.....	.....	.....	.....	.....
<i>Fusarium</i> sp. 3	.....T.....	.....T.....	.....	.....	.....	.....
<i>F. sacchari</i> (MP-B)	.....T.....	.....	.....C.....	.....	.....	.....
<i>F. fujikuroi</i> (MP-C)	.....T.....	.....	.....	.....	.....	.....
<i>F. proliferatum</i> (MP-D)	.....T.....	.....	.....	.....	.....	.....

	310	320	330	340	350	360
<i>F. inflexum</i>	CAACAACGGC	ACCATCGACT	TTCCTGGTGC	GTAATATTCC	AAGACGATTA	GAGGACGGTC
<i>Fusarium</i> sp. 2	.....	.....	.....	.....G.....	.....G...C.....	.....
<i>Fusarium</i> sp. 4	.....T.....	.....	.....	.....G.....	.....G...C.....	.....
<i>F. guttiforme</i>	.....T.....	.....	.....	.....G.....	.....G...C.....	.....
<i>F. begoniae</i>	.....	.....	.....	.....G.....	.....G...C.....	.....
<i>F. bulbicola</i>	.....T.....	.....	.....	.....G.....	.....G...C.....	.....
<i>F. circinatum</i> (MP-H)	.....T.....	.....	.....	.....G.....	.....G...C.....	.....T.....
<i>F. subglutinans</i> (MP-E)	.....T..T.....	.....	.....	.....G.....	.....G...C.....	.....
<i>Fusarium</i> sp. 1	.....T.....	.....	.....	.....G.....	.....G...C.....	.....
<i>F. thapsinum</i> (MP-F)	.....	.....	.....T.....	.....G.....	.....	.....G.....
<i>F. verticillioides</i> (MP-A)	.....	.....	.....T.....	.....G..C.....	.....	.....T.....
<i>F. nygamai</i> (MP-G)	.....	.....	.....T.....	.....G.....	.....G...C.....	.....
<i>F. pseudocircinatum</i>	.....	.....	.....T.....	.....G.....	.....	.....
<i>F. concentricum</i>	.....	.....T.....	.....	.....G.....	.....A.T.....	.....
<i>Fusarium</i> sp. 3	.....	.....	.....	.....G.....	.....A.....	.....
<i>F. sacchari</i> (MP-B)	.....	.....	.....	.....G..T.....	.....T.....	.....T..T..T
<i>F. fujikuroi</i> (MP-C)	.....	.....	.....	.....G.....	.....A.T.....	.....
<i>F. proliferatum</i> (MP-D)	.....	.....	.....	.....G.....	.....A.T.....	.....



	370	380	390	400	410	420
<i>F. inflexum</i>	-AGTACTAAC	CATTGGGTAA	AGAGTTCCTC	ACCATGATGG	CGCGCAAGAT	GAAGGATACC
<i>Fusarium</i> sp. 2	-.....	.C.....	.....	.....	.....	.....
<i>Fusarium</i> sp. 4	-.....	.C.....	.....	.....	.....	.....
<i>F. guttiforme</i>	-.....	.C.....	.....	.....	.....	.....
<i>F. begoniae</i>	-.....	.C.....	.....	.....	.....	.....
<i>F. bulbicola</i>	-.....	.C.....	.....	.....	.....	.....
<i>F. circinatum</i> (MP-H)	-.....	.C.....	.....	.....	.....	.....
<i>F. subglutinans</i> (MP-E)	-.....	.C.....	.....	.....	.....	.....
<i>Fusarium</i> sp. 1	-.....	.C.....	.....	.....	.A.....	.....
<i>F. thapsinum</i> (MP-F)	G.....	.N.A.....	.....	.....	.....	.....
<i>F. verticillioides</i> (MP-A)	G.....	.A.....	.....	.T.....	.....	.....
<i>F. nygamai</i> (MP-G)	G.....	.....	.....	.....	.....	.....
<i>F. pseudocircinatum</i>	G..A.....	.....	.....	.T.....	.....	.....
<i>F. concentricum</i>	-.....	.C.....	.....	.....	.....	.....
<i>Fusarium</i> sp. 3	-.....	.C.....	.....	.....	.....	.....
<i>F. sacchari</i> (MP-B)	-.....	.C.....	.....	.....	.....	.....
<i>F. fujikuroi</i> (MP-C)	-.....	.C.....	.....	.....	.....	.....
<i>F. proliferatum</i> (MP-D)	-.....	.C.....	.....	.....	.....	.....

	430	440	450	460	470	480
<i>F. inflexum</i>	GACTCTGAGG	AGGAGATCCG	CGAGGCTTTC	AAGGTGTTTCG	ACCGTGACAA	CAACGGTTTC
<i>Fusarium</i> sp. 2	.....	.C.....	T.....	.....	.....	.....
<i>Fusarium</i> sp. 4	.....	.C.....	T.....	.....	.....	.....
<i>F. guttiforme</i>	.....	.C.....	T.....	.....	.....	.....
<i>F. begoniae</i>	.....	.C.....	T.....	.....	.....	.....
<i>F. bulbicola</i>	.....	.C.....	T.....	.....	.....	.....
<i>F. circinatum</i> (MP-H)	.....	.C.....	T.....	.....	.....	.....
<i>F. subglutinans</i> (MP-E)	.....	.C.....	T.....	.....	.....	.....
<i>Fusarium</i> sp. 1	.....	.C.....	T.....	.....	.....	.....
<i>F. thapsinum</i> (MP-F)	.....	.....	T.....	.....	.T.....	.....
<i>F. verticillioides</i> (MP-A)	.....	.....	G.....	.....	.T.....	.....
<i>F. nygamai</i> (MP-G)	.....	.....	T.....	.....	.T.....	.....
<i>F. pseudocircinatum</i>	.....	.....	T.....	.....	.T.....	.....
<i>F. concentricum</i>	.....	.....	T.....	.....	.....	.....
<i>Fusarium</i> sp. 3	.....	.....	T.....	.....	.....	.....
<i>F. sacchari</i> (MP-B)	.....	.C.....	T.....	.....	.....	.....
<i>F. fujikuroi</i> (MP-C)	.....	.....	T.....	.....	.....	.....
<i>F. proliferatum</i> (MP-D)	.....	.....	T.....	.....	.....	.....

	490	500	510	520	530	540
<i>F. inflexum</i>	ATTTCTGCTG	CTGAGCTTCG	ACATGTCATG	ACCTCCATCG	GCGAGAAGCT	CACTGATGAT
<i>Fusarium</i> sp. 2	.....	.....	.....	.....	.....	.....
<i>Fusarium</i> sp. 4	.....	.....	.....	.....	.....	.....
<i>F. guttiforme</i>	.....	.....	.....	.....	.....	.....
<i>F. begoniae</i>	.....	.....	.....	.....	.....	.....
<i>F. bulbicola</i>	.....	.....	.....	.....	.....	.....
<i>F. circinatum</i> (MP-H)	.....	.....	.....	.....	.....	.....
<i>F. subglutinans</i> (MP-E)	.....	.....	.....	.....	.....	.....
<i>Fusarium</i> sp. 1	.....	.....	.....	.....	.....	.....
<i>F. thapsinum</i> (MP-F)	.....	.....	.....	.....	.T.....	.....
<i>F. verticillioides</i> (MP-A)	.....	.....	.....	.....	.T.....	.....
<i>F. nygamai</i> (MP-G)	.....	.....	.....	.....	.T.....	.....
<i>F. pseudocircinatum</i>	.....	.....	.....	.....	.T.....	.....
<i>F. concentricum</i>	.....	.A..A.	.....	.....	.....	.....
<i>Fusarium</i> sp. 3	.....	.A..A.	.....	.....	.....	.....
<i>F. sacchari</i> (MP-B)	.....	.A..A.	.....	.....	.....	.....
<i>F. fujikuroi</i> (MP-C)	.....	.A..A.	.....	.....	.....	.....
<i>F. proliferatum</i> (MP-D)	.....	.A..A.	.....	.....	.....	.....



	550	560	570	580	590	600
<i>F. inflexum</i>	GAGGTTGATG	AGATGATCCG	AGAGGCTGAC	CAGGACGGCG	ATGGCCGAAT	CGACTGTGAG
<i>Fusarium</i> sp. 2	.....	.....	.....	.....T.....	.....	.....
<i>Fusarium</i> sp. 4	.....	.....	.....	.....T.....	.....	.....
<i>F. guttiforme</i>	.....	.....	.....	.....T.....	.....	.....
<i>F. begoniae</i>	.....	.....	.....	.....T.....	.....	.....
<i>F. bulbicola</i>	.....	.....	.....	.....	.....	.....
<i>F. circinatum</i> (MP-H)	.....	.....	.....	.....	.....	.....
<i>F. subglutinans</i> (MP-E)	.....	.....	.....	.....	.....	.....
<i>Fusarium</i> sp. 1	.....	.....	.....	.....	.....	.....
<i>F. thapsinum</i> (MP-F)	.....	.....	.....	.....	.....	.....
<i>F. verticillioides</i> (MP-A)	.....	.....	.....	.....	.....	.....
<i>F. nygamai</i> (MP-G)	.....	.....	.....	.....	.....	.....
<i>F. pseudocircinatum</i>	.....	.....	.....	.....	.....	.....
<i>F. concentricum</i>	.....	.....	.....	.....	.....	.....G.
<i>Fusarium</i> sp. 3	.....	.....	.....	.....	.....	.....G.
<i>F. sacchari</i> (MP-B)	.....	.....	.....	.....	.....	.....G.
<i>F. fujikuroi</i> (MP-C)	.....	.....	.....	.....	.....	.....G.
<i>F. proliferatum</i> (MP-D)	.....	.....	.....	.....	.....	.....G.

	610	620	630	640	650	660
<i>F. inflexum</i>	TTGCTTGAGA	TTG-GATATA	TAGTACCAAC	GTCCAGTTAC	TGACAAGACT	ATAGACAACG
<i>Fusarium</i> sp. 2	....C.....	..A-.....	..A.....	.....--..	.....C	..C.....
<i>Fusarium</i> sp. 4	....C.....	..A-.....	..A.....	.....--..	.....C	..C.....
<i>F. guttiforme</i>	....C.....	..A-.....	..A.....	.....--..	.....C	..C.....
<i>F. begoniae</i>	....C.....	..A-.....	..A.....	.....--..	.....C	..C.....
<i>F. bulbicola</i>	....C.....	..A-.....	..A.....	.....--..	.....C	..C.....
<i>F. circinatum</i> (MP-H)	....C.....	..A-.....	..A.....	.....--..	.....C	..C.....
<i>F. subglutinans</i> (MP-E)	....C.....	..A-.....	--A.....	.....--..	.....C	..C.....
<i>Fusarium</i> sp. 1	....C.....	..A-.....	--A.....	.....--..	.....C	..C.....
<i>F. thapsinum</i> (MP-F)	....C.....	..A-.....	..A.....	..G..A...	.....G...	..C.....
<i>F. verticillioides</i> (MP-A)	....C.....	..A-.....	..A.....T	..G..A...	.....G...	..C.....
<i>F. nygamai</i> (MP-G)	....C.....	..A-.....	..A.....	..G..A...	.....G...	..C.....
<i>F. pseudocircinatum</i>	....C.....	..A-.....	..A.TT...	..G..A...	.....G...	..C.....
<i>F. concentricum</i>	....C.....	..A-.....	..AC.A...	T.....	.....G...	..C.....
<i>Fusarium</i> sp. 3	....C.....	..AA.....	..AC.G...	.....	.....G...	..C.....
<i>F. sacchari</i> (MP-B)	....C.....	..A-.....	..AC.A...	..A.GC.G.-	---.....	..C.....
<i>F. fujikuroi</i> (MP-C)	....C.....	..A-.....	..AC.A...	.....	.....G...	..C.....
<i>F. proliferatum</i> (MP-D)	....C.....	..A-.....	..AC.A...	.....G...	.....G...	..C.....

	670	682
<i>F. inflexum</i>	AGTTCGTCCA	ACTCATGATGCA
<i>Fusarium</i> sp. 2	.....	.....
<i>Fusarium</i> sp. 4	.....	.....
<i>F. guttiforme</i>	.....	.....
<i>F. begoniae</i>	.....	.....
<i>F. bulbicola</i>	.....	.....
<i>F. circinatum</i> (MP-H)	.....	.....
<i>F. subglutinans</i> (MP-E)	.....	.....
<i>Fusarium</i> sp. 1	.....	.....
<i>F. thapsinum</i> (MP-F)	.....	.....
<i>F. verticillioides</i> (MP-A)	.....	.....
<i>F. nygamai</i> (MP-G)	.....	.....
<i>F. pseudocircinatum</i>	.....	.....
<i>F. concentricum</i>	.....	.....
<i>Fusarium</i> sp. 3	.....	.....
<i>F. sacchari</i> (MP-B)	.....	.....
<i>F. fujikuroi</i> (MP-C)	.....	.....
<i>F. proliferatum</i> (MP-D)	.....	.....



MtSSU

	10	20	30	40	50	60
<i>F. inflexum</i>	GC-TAACGGC	TGAACTGGCA	ACTTGGAGAA	GTGGCAAGTC	TTCCAGTATG	GGGAGCAAAA
<i>Fusarium</i> sp. 2	..C.....	.....	.....	.....	.....	.....
<i>Fusarium</i> sp. 4	..C.....	.....	.....	.....	.....	.....
<i>F. guttiforme</i>	.....	.....	.....	.....	.....	.....
<i>F. begoniae</i>	.....	.....	.....	.....	.....	.....
<i>F. bulbicola</i>	.....	.....	.....	.....	.....	.....
<i>F. circinatum</i> (MP-H)	.....	.....	.....	.....	.....	.....
<i>F. subglutinans</i> (MP-E)	.....	.....	.....	.....	.....	.....
<i>Fusarium</i> sp. 1	..C.....	.....	.....	.....	.....	.....
<i>F. thapsinum</i> (MP-F)	.....	.....	.....	.....	.....	.....
<i>F. verticillioides</i> (MP-A)	.....	.....	.....	.....	.....	.....
<i>F. nygamai</i> (MP-G)	.....	.....	.....	.....	.....	.....
<i>F. pseudocircinatum</i>	.....	.....	.....	.....	.....	.....
<i>F. concentricum</i>	.....	.....	.....	.....	.....	.....
<i>Fusarium</i> sp. 3	.....	.....	.....	.....	.....	.....
<i>F. sacchari</i> (MP-B)	.....	.....	.....	.....	.....	.....
<i>F. fujikuroi</i> (MP-C)	.....	.....	.....	.....	.....	.....
<i>F. proliferatum</i> (MP-D)	.....	.....	.....	.....	.....	.....

	70	80	90	100	110	120
<i>F. inflexum</i>	CAGCTATGGG	TCAAGTCCGA	TATCTTTAGG	AG-----AAG	----TCTTAT	TGTGAGGGCG
<i>Fusarium</i> sp. 2	.....	.....	.....	.....	.....	.....
<i>Fusarium</i> sp. 4	.....	.....	.....	.....	.....	.....
<i>F. guttiforme</i>	.....	.....	.....	.....	.....	.....
<i>F. begoniae</i>	.....	.....	.....	.....	.....	.....
<i>F. bulbicola</i>	.....	..G..	.....	.....	.....	.....
<i>F. circinatum</i> (MP-H)	.....	.....	.....	.....	.....	.....
<i>F. subglutinans</i> (MP-E)	.....	.....	.....	..GCGG...	CTCC.....	.....
<i>Fusarium</i> sp. 1	.....	.....	.....	..GCGG...	CTCC.....	.....
<i>F. thapsinum</i> (MP-F)	.....	.....	.....	..GCGG...	CTCC.....	.....
<i>F. verticillioides</i> (MP-A)	.....	.....	.....	.....	.....	.....
<i>F. nygamai</i> (MP-G)	.....	.....	.....	.....	.....	.....
<i>F. pseudocircinatum</i>	.....	.....	.....	..GCGG...	CTCC.....	.....
<i>F. concentricum</i>	.....	..T..	.....	..GGGCG...	CTCC.....	.....
<i>Fusarium</i> sp. 3	.....	..T..	.....	..GCGG...	CTCC.....	.....
<i>F. sacchari</i> (MP-B)	.....	..T..	.....	..GGGGG...	CTCC.....	.....
<i>F. fujikuroi</i> (MP-C)	.....	..T..	.....	..GGGCG...	CTCC.....	.....
<i>F. proliferatum</i> (MP-D)	.....	..T..	.....	..GGGCG...	CTCC.....	.....

	130	140	150	160	170	180
<i>F. inflexum</i>	AGTTATATAA	CACCATAGGA	CTGGCCGCC	CATATGAAAA	GATTATATTA	GAATTGAATG
<i>Fusarium</i> sp. 2	...T....	.....	...T....	.....	.....	.....
<i>Fusarium</i> sp. 4	...T....	.....	...T....	.....	.....	.....
<i>F. guttiforme</i>	...T....	.....	...n....	.....	.....	.....
<i>F. begoniae</i>	...T....	.....	.....	.....	.....	...C..
<i>F. bulbicola</i>	...T....	.....	...T....	.....	.....	.....
<i>F. circinatum</i> (MP-H)	...T....	.....	...T....	.....	.....	.....
<i>F. subglutinans</i> (MP-E)	...T....	.....	.....	.....	.....	.....
<i>Fusarium</i> sp. 1	...T....	.....	...n.nn..	.....	.....	.....
<i>F. thapsinum</i> (MP-F)	...T....	.....	.....	.....	.....	.....
<i>F. verticillioides</i> (MP-A)	...T....	.....	.....	.....	.....	.....
<i>F. nygamai</i> (MP-G)	...T....	.....	.....	.....	.....	.....
<i>F. pseudocircinatum</i>	...T....	.....	...n....	.....	.....	.....
<i>F. concentricum</i>	.C.....	.....	.....	.....	.....	.....
<i>Fusarium</i> sp. 3	.C.....	.....	.....	.....	.....	.....
<i>F. sacchari</i> (MP-B)	.....	.....	.....	.....	.....	.....
<i>F. fujikuroi</i> (MP-C)	.....	.....	.....	.....	.....	.....
<i>F. proliferatum</i> (MP-D)	.....	.....	.....	.....	.....	.....





	190	200	210	220	230	240
<i>F. inflexum</i>	AAGCTTTGTT	TATATATTGA	TAATGACAGT	ATATATATCG	TGTCTTGACT	AATTGCGTGC
<i>Fusarium</i> sp. 2	.....	.....	.....	.....	.....	.....
<i>Fusarium</i> sp. 4	.....	.....	.....	.....	.....	.....
<i>F. guttiforme</i>	.....	.....	.....	.....	.....	.....
<i>F. begoniae</i>	.....	.....	.....	.....	.....	.....
<i>F. bulbicola</i>	.....	.....	.....	.....	.....	.....
<i>F. circinatum</i> (MP-H)	.....	.....	.....	.....	.....	.....
<i>F. subglutinans</i> (MP-E)	.....	.....	.....	.....	.....	.....
<i>Fusarium</i> sp. 1	.....	.....	.....	.....	.....	.....
<i>F. thapsinum</i> (MP-F)	.....	.....	.....	.....	.....	.....
<i>F. verticillioides</i> (MP-A)	.....	.....	.....	.....	.....	.....
<i>F. nygamai</i> (MP-G)	.....	.....	.....	.....	.....	.....
<i>F. pseudocircinatum</i>	.....	.....	.....	.....	.....	.....
<i>F. concentricum</i>	.....	.....	.....	.....	.....	.....
<i>Fusarium</i> sp. 3	.....	.....	.....	.....	.....	.....
<i>F. sacchari</i> (MP-B)	.....	.....	.....	.....	.....	.....
<i>F. fujikuroi</i> (MP-C)	.....	.....	.....	.....	.....	.....
<i>F. proliferatum</i> (MP-D)	.....	.....	.....	.....	.....	.....

	250	260	270	280	290	300
<i>F. inflexum</i>	CAGCAGTCGC	GGTAATACGT	AAGAGACTAG	TGTTATTCAT	CTTAATTAGG	TTTAAAGGGT
<i>Fusarium</i> sp. 2	.....	.....	.....	.....	.....	.....
<i>Fusarium</i> sp. 4	.....	.....	.....	.....	.....	.....
<i>F. guttiforme</i>	.....	.....	.....	.....	.....	.....
<i>F. begoniae</i>	.....	.....	.....	.....	.....	.....
<i>F. bulbicola</i>	.....	.....	.....	.....	.....	.....
<i>F. circinatum</i> (MP-H)	.....	.....	.....	.....	.....	.....
<i>F. subglutinans</i> (MP-E)	.....	.....	.....	.....	.....	.....
<i>Fusarium</i> sp. 1	.....	.....	.....	.....	.....	.....
<i>F. thapsinum</i> (MP-F)	.....	.....	.....	.....	.....	.....
<i>F. verticillioides</i> (MP-A)	.....	.....	.....	.....	.....	.....
<i>F. nygamai</i> (MP-G)	.....	.....	.....	.....	.....	.....
<i>F. pseudocircinatum</i>	.....	.....	.....	.....	.....	.....
<i>F. concentricum</i>	.....	.....	.....	.....	.....	.....
<i>Fusarium</i> sp. 3	.....	.....	.....	.....	.....	.....
<i>F. sacchari</i> (MP-B)	.....	.....	.....	.....	.....	.....
<i>F. fujikuroi</i> (MP-C)	.....	.....	.....	.....	.....	.....
<i>F. proliferatum</i> (MP-D)	.....	.....	.....	.....	.....	.....

	310	320	330	340	350	360
<i>F. inflexum</i>	ACCCAGACGG	TCAATATAGC	TTATAAAATG	TTAGTACTTG	ACTAGAGTTT	TATGTAAGAG
<i>Fusarium</i> sp. 2	.....	.....	.....	.....	.....	.....
<i>Fusarium</i> sp. 4	.....	.....	.....	.....	.....	.....
<i>F. guttiforme</i>	.....	.....	.....	.....	.....	.....
<i>F. begoniae</i>	.....	.....	.....	.....	.....	.....
<i>F. bulbicola</i>	.....	.....	.....	.....	.....	.....
<i>F. circinatum</i> (MP-H)	.....	.....	.....	.....	.....	.....
<i>F. subglutinans</i> (MP-E)	.....	.....	.....	.....	.....	.....
<i>Fusarium</i> sp. 1	.....	.....	.....	.....	.....	.....
<i>F. thapsinum</i> (MP-F)	.....	.....	.....	.....	.....	.....
<i>F. verticillioides</i> (MP-A)	.....	.....	.....	.....	.....	.....
<i>F. nygamai</i> (MP-G)	.....	.....	.....	.....	.....	.....
<i>F. pseudocircinatum</i>	.....	.....	.....	.....	.....	.....
<i>F. concentricum</i>	.....	.....	.....	.....	.....	.....
<i>Fusarium</i> sp. 3	.....	.....	.....	.....	.....	.....
<i>F. sacchari</i> (MP-B)	.....	.....	.....	.....	.....	.....
<i>F. fujikuroi</i> (MP-C)	.....	.....	.....	.....	.....	.....
<i>F. proliferatum</i> (MP-D)	.....	.....	.....	.....	.....	.....



	370	380	390	400	410	420
<i>F. inflexum</i>	GGCAGTACTT	GAGGAGGAGA	GATGAAATTT	CGTGATACCA	AAGGGACTCT	GTAAAGGCCA
<i>Fusarium</i> sp. 2	.....	.....	.....	.....	.....G	.....
<i>Fusarium</i> sp. 4	.....	.....	.....	.....	.....G	.....
<i>F. guttiforme</i>	.....	.....	.....	.....	.....G	.....
<i>F. begoniae</i>	.....	.....	.....	.....	.....G	.....
<i>F. bulbicola</i>	.....	.....	.....	.....	.....	.....
<i>F. circinatum</i> (MP-H)	.....	.....	.....	.....	.....G	.....
<i>F. subglutinans</i> (MP-E)	.....	.....	.....	.....	.....G	.....
<i>Fusarium</i> sp. 1	.....	.....	.....	.....	.....G	.....
<i>F. thapsinum</i> (MP-F)	.....	.....	.....	.....	.....	.....
<i>F. verticillioides</i> (MP-A)	.....	.....	.....	.....	.....	.....
<i>F. nygamai</i> (MP-G)	.....	.....	.....	.....	.....	.....
<i>F. pseudocircinatum</i>	.....	.....	.....	.....	.....	.....
<i>F. concentricum</i>	.....	.....	.....	.....	.....	.....
<i>Fusarium</i> sp. 3	.....	.....	.....	.....	.....	.....
<i>F. sacchari</i> (MP-B)	.....	.....	.....	.....	.....	.....
<i>F. fujikuroi</i> (MP-C)	.....	.....	.....	.....	.....	.....
<i>F. proliferatum</i> (MP-D)	.....	.....	.....	.....	.....	.....

	430	440	450	460	470	480
<i>F. inflexum</i>	AGGCAGCCCT	CTATGTAAAA	ACTGACGTTG	AAGGACGAAG	GCACAGAGAA	CAAACAGGAT
<i>Fusarium</i> sp. 2	.....	.....G.....	.....	.....	.....	.....
<i>Fusarium</i> sp. 4	.....	.....	.....	.....	.....	.....
<i>F. guttiforme</i>	.....	.....G.....	.....	.....	.....	.....
<i>F. begoniae</i>	.....	.....G.....	.....	.....	.....	.....
<i>F. bulbicola</i>	.....	.....	.....	.....	.....	.....
<i>F. circinatum</i> (MP-H)	.....	.....G.....	.....	.....	.....	.....
<i>F. subglutinans</i> (MP-E)	.....	.....G.....	.....	.....	.....	.....
<i>Fusarium</i> sp. 1	.....	.....G.....	.....	.....	.....	.....
<i>F. thapsinum</i> (MP-F)	.....	.....	.....	.....	.....	.....
<i>F. verticillioides</i> (MP-A)	.....	.....	.....	.....	.....	.....
<i>F. nygamai</i> (MP-G)	.....	.....	.....	.....	.....	.....
<i>F. pseudocircinatum</i>	.....	.....	.....	.....	.....	.....
<i>F. concentricum</i>	.....	.....	.....	.....	.....	.....
<i>Fusarium</i> sp. 3	.....	.....	.....	.....	.....	.....
<i>F. sacchari</i> (MP-B)	.....	.....	.....	.....	.....	.....
<i>F. fujikuroi</i> (MP-C)	.....	.....	.....	.....	.....	.....
<i>F. proliferatum</i> (MP-D)	.....	.....	.....	.....	.....	.....

	490	500	510	520	530	540
<i>F. inflexum</i>	TAGATACCCA	AGTAGTCTTT	GCAGTAAATG	ATGAATGCCA	TAGGTTAGAT	T-GA--TCAA
<i>Fusarium</i> sp. 2	.....	.....	.....	.....	.....	CT.GG..GG.
<i>Fusarium</i> sp. 4	.....	.....	.....	.....	.....	CT.GG..GG.
<i>F. guttiforme</i>	.....	.....	.....	.....	.....	CT.GG..GG.
<i>F. begoniae</i>	.....	.....	.....	.....	.....	CT.GG..GG.
<i>F. bulbicola</i>	.....	.....	.....	.....	.....	CT.GC..GG.
<i>F. circinatum</i> (MP-H)	.....	.....	C.....	.....	.....	CT.GG..GG.
<i>F. subglutinans</i> (MP-E)	.....	.....	.....	.....	.....	CT..GT.G-G
<i>Fusarium</i> sp. 1	.....	.....	.....	.....	.....	CT..GT.G-G
<i>F. thapsinum</i> (MP-F)	.....	.....	.....	.....	.....	-..GG..GGG
<i>F. verticillioides</i> (MP-A)	.....	.....	.....	.....	.....	-..GG..GGG
<i>F. nygamai</i> (MP-G)	.....	.....	.....	.....	.....	-..GG..GGG
<i>F. pseudocircinatum</i>	.....	.....	.....	.....	.....	-..GG..GGG
<i>F. concentricum</i>	.....	.....	.....	.....	.....	-..GG..GGG
<i>Fusarium</i> sp. 3	.....	.....	.....	.....	.....	-..GG..GGG
<i>F. sacchari</i> (MP-B)	.....	.....	.....	.....	.....	-..GG..GGG
<i>F. fujikuroi</i> (MP-C)	.....	.....	.....	.....	.....	-..GG..GGG
<i>F. proliferatum</i> (MP-D)	.....	.....	.....	.....	.....	-..GG..GGG



	550	560	570	580	590	600
<i>F. inflexum</i>	TTATAGTC-T	AG--G-GTTA	GTCTAGCAAA	CTAATG-CCC	TATGATAT-A	ATTCAAATA
<i>Fusarium</i> sp. 2	-.--.....	..TT.A....	..T..CT...	.....AT.	...ACA.G.C	CAG.C.T.G.
<i>Fusarium</i> sp. 4	-.--.....	..TT.A....	..T..CT...	.....AT.	...ACG.G.C	CAG.C.T.C.
<i>F. guttiforme</i>	-.--.....	..TT.A....	..T..CT...	.....AT.	...ACA.G.C	CAG.C.T.G.
<i>F. begoniae</i>	-.--.....	..TT.A....	..T..CT...	.....AT.	...ACA.G.C	CAG.C.T.G.
<i>F. bulbicola</i>	-.--.....	..TT.A....	..T..CT...	.....AT.	..CACG.G.C	CAG.C.T.G.
<i>F. circinatum</i> (MP-H)	-.--.....	..TT.A....	..T..CT...	.....AT.	...ACG.G.C	CAG.C.T.G.
<i>F. subglutinans</i> (MP-E)	-.--.....	..TT.A....	..T..CT...	.....AT.	...ACA.G.C	CAG.CTT.G.
<i>Fusarium</i> sp. 1	-.--.....	..TT.A....	..T..CT...	.....AT.	...ACA.G.C	CAG.CTT.G.
<i>F. thapsinum</i> (MP-F)	-.--..TG.	..TT.A....	A.T.....	.....AT.	..GAC..GTC	CAC...T...
<i>F. verticillioides</i> (MP-A)	...--..G.	..TT.A....	..T.....	.....GATT	C.GAC..GTC	CAC...-T...
<i>F. nygamai</i> (MP-G)	-.--.....	..TT.A....	A.T.....	.....AT.	..GAC..GTC	CAC...-T...
<i>F. pseudocircinatum</i>	-.--..TG.	..TT.A....	A.T.....	.....AT.	..GAC..G.C	CCA.C.T...
<i>F. concentricum</i>	-CTC-.....	..TT.A....	..T.....	.....AT.	..GACG.G.C	CCA.CGT...
<i>Fusarium</i> sp. 3	-CTC-.....	..TT.A....	..T.....	.....AT.	..GACG.G.C	CCA.CGT...
<i>F. sacchari</i> (MP-B)	-CTC-.....	..TT.A....	..CT.....	.....AT.	..G.TG.G.C	CCA...T...
<i>F. fujikuroi</i> (MP-C)	-CTC-.....	..TT.A....	..T.....	.....AT.	..GACG.G.C	CCA.CGT...
<i>F. proliferatum</i> (MP-D)	-CTC-.....	..TT.A....	..T.....	.....AT.	..GACG.G.C	CCA.CGT...

	610	620	630	640	650	660
<i>F. inflexum</i>	TCTGGTCTAT	AAATGAAAGT	GTAAGCATT	CACCTCAAGA	GTAATGTGGC	AACGCAGGAA
<i>Fusarium</i> sp. 2	.T.....	.....	.....	.....	.....	.....
<i>Fusarium</i> sp. 4	.T.....	.....	.....	.....	.....	.....
<i>F. guttiforme</i>	.T.....	.....	.....	.....	.....	.....
<i>F. begoniae</i>	.T.....	.....	.....	.....	.....	.....
<i>F. bulbicola</i>	.T.....	.....	.....	.....	.....	.....
<i>F. circinatum</i> (MP-H)	.T.....	.....	.....	.....	.....	.....
<i>F. subglutinans</i> (MP-E)	.T.....	.....	.....	.....	.....	.....
<i>Fusarium</i> sp. 1	.T.....	.....	.....	.....	.....	.....
<i>F. thapsinum</i> (MP-F)	.T.....	.....	.....	.....	.....	.....
<i>F. verticillioides</i> (MP-A)	.T.....	.....	.....	.....	.....	.....
<i>F. nygamai</i> (MP-G)	.T.....	.....	.....	.....	.....	.....
<i>F. pseudocircinatum</i>	.T.....	.....	.....	.....	.....	.....
<i>F. concentricum</i>	.T.....	.....	.....	.....	.....	.....
<i>Fusarium</i> sp. 3	.T.....	.....	.....	.....	.....	.....
<i>F. sacchari</i> (MP-B)	.T.....	.....	.....	.....	.....	.....
<i>F. fujikuroi</i> (MP-C)	.T.....	.....	.....	.....	.....	.....
<i>F. proliferatum</i> (MP-D)	.T.....	.....	.....	.....	.....	.....

	670	680	690	698
<i>F. inflexum</i>	CTGAAATCAC	TAGACCGTTT	CTGACACCAG	TAGTGAAG
<i>Fusarium</i> sp. 2	.....	.....	.....	.....
<i>Fusarium</i> sp. 4	.....	.....	.....nnnn	nnnnnnnn
<i>F. guttiforme</i>	.....	.....	.....	.....
<i>F. begoniae</i>	.....	.....	.....	.....
<i>F. bulbicola</i>	.....	.....	.....	.....
<i>F. circinatum</i> (MP-H)	.....	..C..A..C	.....A	.....
<i>F. subglutinans</i> (MP-E)	.....	.....	.....	.....
<i>Fusarium</i> sp. 1	.....	.....	.....	.....
<i>F. thapsinum</i> (MP-F)	.....	.....	.....	.....
<i>F. verticillioides</i> (MP-A)	.....	.....	.....	.....
<i>F. nygamai</i> (MP-G)	.....	.....	.....	.....
<i>F. pseudocircinatum</i>	.....	.....	.....	.....
<i>F. concentricum</i>	.....	.....	.....	.....
<i>Fusarium</i> sp. 3	.....	.....	.....	.....
<i>F. sacchari</i> (MP-B)	.....	.....	.....	.....
<i>F. fujikuroi</i> (MP-C)	.....	.....	.....	.....
<i>F. proliferatum</i> (MP-D)	.....	.....	.....	.....



### Partial $\beta$ -tubulin

	10	20	30	40	50	60
<i>F. inflexum</i>	nnnnnnnnnn	nnnnnnnnnn	nnnnnnnnnn	nnnnnnnnnn	nnnnnnGTTG	CACGCGTTGA
<i>Fusarium</i> sp. 2	ATGCGTGAGA	TTGTAAGTAC	TTCTCTTTT	AAGTTCGTGC	TGTGCT...	.....
<i>Fusarium</i> sp. 4	ATGCGTGAGA	TTGTAAGTAC	CTCTCTTTT	AAGTTCGTGT	TGTGCT...	.....
<i>F. guttiforme</i>	nnnnnnnnnn	nnnnnnnnnn	nnnnnnnnnn	nnGTTTCGTGT	TGTGCT...	.....
<i>F. begoniae</i>	ATGCGTGAGA	TTGTAAGTAC	CTCTCTTTT	AAGTTCGTGT	TGTGCT...	.....
<i>F. bulbicola</i>	ATGCGTGAGA	TTGTAAGTAC	CTCTCTTTT	AAGTTCGTGT	TGTGCT...	.....
<i>F. circinatum</i> (MP-H)	ATGCGTGAGA	TTGTAAGTAC	CTCTCTTTT	AAGTTCGTGT	TGTGCT...	.....
<i>F. subglutinans</i> (MP-E)	nnnnnnnnnn	nnnnnnnnnn	nnnnnnnnnn	nnGTTTCGTGT	TGTGCT...	.....
<i>Fusarium</i> sp. 1	ATGCGTGAGA	TTGTAAGTGC	CTCTCTTTT	AAGTTCGTGT	TGTGCT...	.....
<i>F. thapsinum</i> (MP-F)	nnnnnnnnnn	nnnnnnnnnn	nnnnnnnnnn	nnGTTTCGTGT	TGTGCT...	.....
<i>F. verticillioides</i> (MP-A)	nnnnnnnnnn	nnnnnnnnnn	nnnnnnnnnn	nnGTTTCGTGC	TGTGCT...	.....C
<i>F. nygamai</i> (MP-G)	nnnnnnnnnn	nnnnnnnnnn	nnnnnnnnnn	nnGTTTCGTGT	TGTGCT...	.....T
<i>F. pseudocircinatum</i>	nnnnnnnnnn	nnnnnnnnnn	nnnnnnnnnn	nnGTTTCGTGT	TGTTCT...	.....
<i>F. concentricum</i>	ATGCGTGAGA	TTGTAAGTAC	CTCTCTTTT	AAGTTCGTAT	TGTGCT...	.....
<i>Fusarium</i> sp. 3	ATGCGTGAGA	TTGTAAGTAC	CTCTCTTCT	AAGTTTGTAT	TGTGCT...	.....
<i>F. sacchari</i> (MP-B)	nnnnnnnnnn	nnnnnnnnnn	nnnnnnnnnn	nnGTTTCGTAT	TGTGCT...	.....
<i>F. fujikuroi</i> (MP-C)	nnnnnnnnnn	nnnnnnnnnn	nnnnnnnnnn	nnGTTTCGTAT	TGTGCT...	.....
<i>F. proliferatum</i> (MP-D)	nnnnnnnnnn	nnnnnnnnnn	nnnnnnnnnn	nnGTTTCGTAT	TGTGCT...	.....

	70	80	90	100	110	120
<i>F. inflexum</i>	GTTTATCGTG	CCCCTGATTC	TACCCC----	-GCTGGGCGG	TGGCAGCTCA	ACGACAATGC
<i>Fusarium</i> sp. 2	.....	.....	.....	.....	.....	.....
<i>Fusarium</i> sp. 4	.....	.....	.....	.....	.....	.....
<i>F. guttiforme</i>	.....	.....	.....	.....	.....	.....
<i>F. begoniae</i>	.....	.....	.....	.....	.....	.....
<i>F. bulbicola</i>	.....	.....	.....	.....	.....	.....
<i>F. circinatum</i> (MP-H)	.....	.....	.....	.....	.....	.....
<i>F. subglutinans</i> (MP-E)	.....G.....	.....	.....	.....	.....	.....
<i>Fusarium</i> sp. 1	.....G.....	.....	.....	.....	.....	.....
<i>F. thapsinum</i> (MP-F)	.....	.....	..TT.TACCC	C.....	.....	.....
<i>F. verticillioides</i> (MP-A)	.....G.....	.....	.....	.....	.....	.....
<i>F. nygamai</i> (MP-G)	.....	.....	.....	.....	.....	G.....
<i>F. pseudocircinatum</i>	.....	.....	.....	..C.....	.....	.....
<i>F. concentricum</i>	.....	.....	.....	.....	.....	.....T.....
<i>Fusarium</i> sp. 3	.....C.C.....	.....	.....	.....	.....	.....T.....
<i>F. sacchari</i> (MP-B)	.....	.....	.....	.....	.....G.....	.....T.....
<i>F. fujikuroi</i> (MP-C)	.....C.....	.....	.....	.....T.....	.....	.....T.....
<i>F. proliferatum</i> (MP-D)	.....C.....	.....	.....	.....T.....	.....	.....T.....

	130	140	150	160	170	180
<i>F. inflexum</i>	ACGATAGCTA	C----CAGCT	TTACCATACC	TTCTGTCAAG	AC-AAGAAGC	TAATCAGATC
<i>Fusarium</i> sp. 2	.....	G----.....	..AT.....	.....	.TG.....	.....
<i>Fusarium</i> sp. 4	.....	G----.....	..AT.....	.....	.TG.....	.....A
<i>F. guttiforme</i>	.....T..	G----.....	..AT.....	.....T..	.TG.....	.....
<i>F. begoniae</i>	.....	G----.....	..AT.....	.....	.TG.....	.....
<i>F. bulbicola</i>	.....	G----.....	..AT.....	.....T	.TG.....	.....
<i>F. circinatum</i> (MP-H)	.....	G----.....	..AT.....	.....T	.TG.....	.....
<i>F. subglutinans</i> (MP-E)	.....	G----.....	..A.....	.....	.TG.....	.....
<i>Fusarium</i> sp. 1	.....	G----.....	..A.....	.....	.TG.....	.....
<i>F. thapsinum</i> (MP-F)	..T....A..	GCTAG.....	..CA.....	.....	..G..A.....	.....
<i>F. verticillioides</i> (MP-A)	..T....A..	GCTAG.....	..CA.....	.....	..G.....	.....
<i>F. nygamai</i> (MP-G)	..T....A..	GCCAG.....	..CA.....	.....	..G.....	.....
<i>F. pseudocircinatum</i>	..T....A..	GCTAG.....	..CA.....	.....	..G.....	.....
<i>F. concentricum</i>	.....	G----.....	..A.C.....	.....	..G.....	.....
<i>Fusarium</i> sp. 3	.....	G----.....	..A.C.....	.....	..G.....	.....
<i>F. sacchari</i> (MP-B)	.....	G----.....	..A.C.....	.....	..G.T.....	.....
<i>F. fujikuroi</i> (MP-C)	.....	G----.....	..A.C.....	..A.C.....	..G.....	.....A
<i>F. proliferatum</i> (MP-D)	.....	G----.....	..A.C.....	.....	..G.....	.....



	190	200	210	220	230	240
<i>F. inflexum</i>	TCTTCTCTAC	AATAGGTTCA	CCTCCAGACC	GGTCAGTGCG	TAAGTGCTCA	TCGCTTCCTC
<i>Fusarium</i> sp. 2	.T.....G.	G.....	.....	.....	.....	.....
<i>Fusarium</i> sp. 4	.T.....G.	G.....	.....	.....	.....	.....
<i>F. guttiforme</i>	.T.....G.	G.....	.....	.....	.....	.....
<i>F. begoniae</i>	.T.....G.	G.....	.....	.....	.....	.....
<i>F. bulbicola</i>	.T.....G.	G.....	.....	.....	.....	.....
<i>F. circinatum</i> (MP-H)	.T.....G.	G.....	.....	.....	.....	.....
<i>F. subglutinans</i> (MP-E)	.T.....G.	G.....	.....	.....	.....	.....
<i>Fusarium</i> sp. 1	.T.....G.	G.....	.....	.....	.....	.....
<i>F. thapsinum</i> (MP-F)	.T.....G.	G.....	.....	.....	.....	.....
<i>F. verticillioides</i> (MP-A)	.T.....G.	G.....	.....	.....	.....	.....
<i>F. nygamai</i> (MP-G)	.T.....G.	G.....	.....	.....	.....	.....
<i>F. pseudocircinatum</i>	.T.....G.	.....	.....T	.....	.....	.....
<i>F. concentricum</i>	.T.....G.	.....	.....	.....	.....	.....
<i>Fusarium</i> sp. 3	.T.....G.	.....	.....	.....	.....	.....
<i>F. sacchari</i> (MP-B)	.T.....G.	.....	.....	.....	.....	.....
<i>F. fujikuroi</i> (MP-C)	.T.....G.	.....	.....	.....	.....	.....
<i>F. proliferatum</i> (MP-D)	.T.....G.	.....	.....	.....	.....	.....

	250	260	270	280	290	300
<i>F. inflexum</i>	AACGTCGCAT	G-CGGGGGAT	GCTCACAATG	TTTATCAGGG	TAACCAAATC	GGTGCTGCTT
<i>Fusarium</i> sp. 2	G.....	..-T.A....	.....G..	.....	.....T	.....
<i>Fusarium</i> sp. 4	G.....	..-T.A....	.....G..	.....	.....T	.....
<i>F. guttiforme</i>	G.....	..-T.A....	.....G..	.....	.....T	.....
<i>F. begoniae</i>	G.....	..-T.A....	.....G..	.....	.....T	.....
<i>F. bulbicola</i>	G.....	..-T.A....	.....G..	.....	.....T	.....
<i>F. circinatum</i> (MP-H)	G.....	..-T.A....	.....G..	.....	.....T	.....
<i>F. subglutinans</i> (MP-E)	G.....	..-T.A....	.....G..	.....	.....T	.....
<i>Fusarium</i> sp. 1	G.....	..-T.A....	.....G..	.....	.....T	.....
<i>F. thapsinum</i> (MP-F)	.....	..-.....	A.....G..	.....	.....T	.....
<i>F. verticillioides</i> (MP-A)	.G.....	.AG.....	A..T..G..	.....	.....T	.....
<i>F. nygamai</i> (MP-G)	.....	..-.....	A..T..G..	..G.....	.....T	.....
<i>F. pseudocircinatum</i>	.....T..	..-.....	A..T..G..	.....	.....T	.....
<i>F. concentricum</i>	.....	..-.....	.....C.	.....	..T..T	.....
<i>Fusarium</i> sp. 3	.....	..-.....	.....C.	.....	.....T	.....
<i>F. sacchari</i> (MP-B)	.....	..-G.....	.....C.	.....	.....T	.....
<i>F. fujikuroi</i> (MP-C)	.....	..-G.....	.....C.	.....	.....T	.....
<i>F. proliferatum</i> (MP-D)	.....	..-.....	.....C.	.....	.....T	.....

	310	320	330	340	350	360
<i>F. inflexum</i>	TCTGGCAAAC	CATCTCTGGC	GAGCACGGCC	TCGACAGCAA	TGGTGTCTAC	AACGGTACCT
<i>Fusarium</i> sp. 2	.....	.....	.....	.....	.....	.....
<i>Fusarium</i> sp. 4	.....	.....	.....	.....	.....	.....
<i>F. guttiforme</i>	.....	.....	.....	.....	.....	.....
<i>F. begoniae</i>	.....	T.....	.....	.....	.....	.....
<i>F. bulbicola</i>	.....	.....	.....	.....	.....	.....C.....
<i>F. circinatum</i> (MP-H)	.....	.....	.....	.....	.....	.....
<i>F. subglutinans</i> (MP-E)	.....	.....	.....	.....	.....	.....
<i>Fusarium</i> sp. 1	.....	.....	.....	.....	.....	.....
<i>F. thapsinum</i> (MP-F)	.....	.....	.....	.....	.....	.....
<i>F. verticillioides</i> (MP-A)	.....	.....	.....	.....	.....	.....T.....
<i>F. nygamai</i> (MP-G)	.....	.....	.....	.....	.....	.....
<i>F. pseudocircinatum</i>	.....	.....	.....	.....	.....	.....
<i>F. concentricum</i>	.....	.....	.....	.....	.....	.....
<i>Fusarium</i> sp. 3	.....	.....	.....	.....	.....	.....
<i>F. sacchari</i> (MP-B)	.....	.....	.....	.....	.....	.....
<i>F. fujikuroi</i> (MP-C)	.....	.....	.....	.....	.....	.....
<i>F. proliferatum</i> (MP-D)	.....	.....	.....	.....	.....	.....





	370	380	390	400	410	420
<i>F. inflexum</i>	CCGAGCTCCA	GCTCGAGCGC	ATGAGTGTCT	ACTTCAACGA	GGTATGCATT	AACAGTCAAT
<i>Fusarium</i> sp. 2	.....	.....T	.....	.....	.....	.....
<i>Fusarium</i> sp. 4	.....	.....T	.....	.....	.....	.....
<i>F. guttiforme</i>	.....	.....T	.....	.....	.....	.....
<i>F. begoniae</i>	.....	.....T	.....	.....	.....	.....
<i>F. bulbicola</i>	.....	.....T	.....	.....	.....T	.....
<i>F. circinatum</i> (MP-H)	.....	.....T	.....	.....	.....T	.....
<i>F. subglutinans</i> (MP-E)	.....	.....T	.....	.....	.....T	.....
<i>Fusarium</i> sp. 1	.....	.....T	.....	.....	.....T	.....
<i>F. thapsinum</i> (MP-F)	.....T	.....	.....T	.....	.....T	.....G.....T
<i>F. verticillioides</i> (MP-A)	.....T	.....	.....T	.....	.....	.....G.....
<i>F. nygamai</i> (MP-G)	.....T	.....	.....T	.....	.....	.....G.....
<i>F. pseudocircinatum</i>	.....T	.....	.....T	.....T	.....	.....G.....
<i>F. concentricum</i>	.....	.....	.....	.....	.....C	.....
<i>Fusarium</i> sp. 3	.....	.....	.....	.....	.....C	.....
<i>F. sacchari</i> (MP-B)	.....	.....	.....	.....	.....	.....
<i>F. fujikuroi</i> (MP-C)	.....	.....	.....	.....	.....C	.....
<i>F. proliferatum</i> (MP-D)	.....	.....	.....	.....	.....C	.....

	430	440	450	460	470	480
<i>F. inflexum</i>	GTCAAGAATT	CCCAAGCTCA	CACAACCTAGG	CCTCTGGCAA	CAAGTATGTT	CCCCGAGCCG
<i>Fusarium</i> sp. 2	.C.....	.....	.....	.....	.....	.....
<i>Fusarium</i> sp. 4	.C.....	.....	.....	.....	.....	.....
<i>F. guttiforme</i>	AC.....	.....	.....	.....	.....	.....
<i>F. begoniae</i>	.C.....	.....T	.....	.....	.....	.....
<i>F. bulbicola</i>	.C.....	.....	.....	.....	.....	.....
<i>F. circinatum</i> (MP-H)	.C.....	.....	.....G	.....	.....	.....
<i>F. subglutinans</i> (MP-E)	.C.....	.....	.....	.....	.....	.....
<i>Fusarium</i> sp. 1	.C.....	.....	.....	.....	.....	.....
<i>F. thapsinum</i> (MP-F)	.....G	.....	.....T	.....	.....	.....
<i>F. verticillioides</i> (MP-A)	.....G	.....A..C	.....T	.....	.....	.....
<i>F. nygamai</i> (MP-G)	.....G	.....	.....T	.....	.....	.....
<i>F. pseudocircinatum</i>	.....G	.....	.....T	.....	.....	.....
<i>F. concentricum</i>	.C...T..C	.....	.....	.....T	.....	.....
<i>Fusarium</i> sp. 3	.C...T..C	.....	.....	.....	.....	.....
<i>F. sacchari</i> (MP-B)	.C...T..C	.....	.....	.....	.....	.....
<i>F. fujikuroi</i> (MP-C)	.C...T..C	.....	.....	.....	.....	.....
<i>F. proliferatum</i> (MP-D)	.C...T..C	.....A	.....	.....	.....	.....

	490	500	510	520	530	540
<i>F. inflexum</i>	TCCTCGTCGA	TCTTGAGCCT	GGTACCATGG	ACGCCGTCCG	TGCTGGTCCC	TTCGGTCAGC
<i>Fusarium</i> sp. 2	.....	.....	.....C	.....	.....A	.....
<i>Fusarium</i> sp. 4	.....	.....	.....	.....	.....A	.....
<i>F. guttiforme</i>	.....	.....	.....	.....T	.....A	.....
<i>F. begoniae</i>	.....	.....	.....	.....	.....A	.....
<i>F. bulbicola</i>	.....	.....	.....	.....	.....A	.....
<i>F. circinatum</i> (MP-H)	.....	.....	.....	.....	.....A	.....
<i>F. subglutinans</i> (MP-E)	.....	.....	.....	.....	.....A	.....
<i>Fusarium</i> sp. 1	.....T	.....	.....	.....	.....A	.....
<i>F. thapsinum</i> (MP-F)	.....	.....C	.....	.....	.....C	.....
<i>F. verticillioides</i> (MP-A)	.....	.....C..C	.....	.....	.....	.....
<i>F. nygamai</i> (MP-G)	.....	.....C	.....	.....	.....	.....
<i>F. pseudocircinatum</i>	.....	.....C	.....C	.....	.....	.....
<i>F. concentricum</i>	.....	.....	.....	.....T	.....	.....
<i>Fusarium</i> sp. 3	.....	.....	.....	.....T	.....	.....
<i>F. sacchari</i> (MP-B)	.....	.....	.....	.....	.....	.....
<i>F. fujikuroi</i> (MP-C)	.....	.....	.....	.....T	.....	.....
<i>F. proliferatum</i> (MP-D)	.....	.....	.....	.....T	.....	.....



550

562

<i>F.inflexum</i>	TCTTCCGTCC	CGACAACTTCGT
<i>Fusarium</i> sp. 2	.....	.....
<i>Fusarium</i> sp. 4	.....	.....
<i>F.guttiforme</i>	.....	.....
<i>F.begoniae</i>	.....	.....
<i>F.bulbicola</i>	.....	.....
<i>F.circinatum</i> (MP-H)	.....	.....
<i>F.subglutinans</i> (MP-E)	.....	.....
<i>Fusarium</i> sp. 1	.....	.....
<i>F.thapsinum</i> (MP-F)	.....	.....
<i>F.verticillioides</i> (MP-A)	.....	.....
<i>F.nygamai</i> (MP-G)	.....	.....
<i>F.pseudocircinatum</i>	.....	T.....n
<i>F.concentricum</i>	.....	.....
<i>Fusarium</i> sp. 3	.....	.....
<i>F.sacchari</i> (MP-B)	.....	.....
<i>F.fujikuroi</i> (MP-C)	.....	.....
<i>F.proliferatum</i> (MP-D)	.....	.....